



H AYUNTAMIENTO MUNICIPAL CONSTITUCIONAL  
DE CHILPANCINGO DE LOS BRAVO, GUERRERO  
2018-2021

# CUENTA PÚBLICA DEL EJERCICIO 2019

## 4.2 INFORMACIÓN CONTABLE

**Balanza de Comprobación  
Del 01 de enero al 31 de  
diciembre de 2019.**

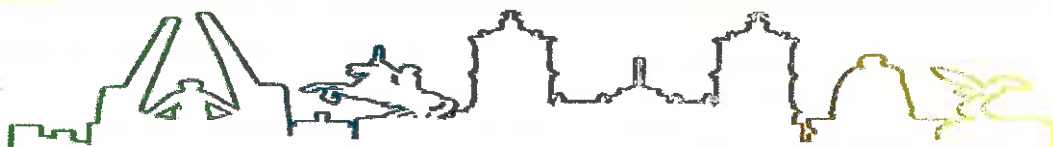

**EL GOBIERNO DE LA GENTE  
CUMPLE, TRABAJA Y AVANZA**



H. AYUNTAMIENTO MUNICIPAL DE CHILPANCINGO, GRO.

SECRETARIA DE FINANZAS Y ADMINISTRACION

CONSOLIDADO



BALANZA DE COMPROBACIÓN DEL 1 DE ENERO AL 31 DE DICIEMBRE DEL 2019

C U E N T A	C O N C E P T O	SALDOS INICIALES		MOVIMIENTOS		SALDOS ACUMULADOS	
		AL 1 DE ENERO DE 2019		ENERO - DICIEMBRE 2019		AL 31 DE DICIEMBRE DE 2019	
		DEBE	HABER	DEBE	HABER	DEBE	HABER
1	ACTIVO	386,956,001.81		2,629,413,692.72		479,279,166.17	
11	ACTIVO CIRCULANTE	219,363,665.60		2,389,498,540.50		296,670,111.32	
111	EFFECTIVO Y EQUIVALENTES	-785,886.19		1,127,631,648.58		2,809,656.33	
1111	EFFECTIVO	58,000.00		0.00		58,000.00	
11112	FONDOS FLUJOS DE CAJA	58,000.00		0.00		58,000.00	
11112021	GASTO CORRIENTE	58,000.00		0.00		58,000.00	
11112021021	EJERCICIO 2016	20,000.00		0.00		20,000.00	
11112021021001	HONORATO MARTINEZ MORA	20,000.00		0.00		20,000.00	
11112021022	EJERCICIO 2017	30,000.00		0.00		30,000.00	
1111202102202	NORA GRACIELA GUEVARA ENCARNACION	15,000.00		0.00		15,000.00	
1111202102204	LUIS TREJO RODRIGUEZ	15,000.00		0.00		15,000.00	
11112021023	EJERCICIO 2017 (OCT-DIC)	8,000.00		0.00		8,000.00	
11112021023003	ARMANDO VILLALVA TEJADA	8,000.00		0.00		8,000.00	
1112	BANCOS/ TESORERIA	-871,836.19		1,127,631,648.58		2,723,656.33	
11121	BANCOS MONEDA NACIONAL	-871,836.19		1,127,631,648.58		2,723,656.33	
11121021	GASTO CORRIENTE	1,804,748.39		618,257,685.11		1,247,700.98	
11121021022	EJERCICIO 2017	18,023.00		0.00		18,023.00	
11121021022003	BBVA BANCOMER, S.A. CTA. 0109961410 PAGO REFERENCIADO 2017	18,023.00		0.00		18,023.00	
11121021024	EJERCICIO 2018	-175,555.11		40,009.81		-136,563.79	
11121021024001	BBVA BANCOMER, S.A. CTA. 0111348105 GASOLINA Y DIESEL 2018	-3,605.82		9.80		-3,596.02	
11121021024002	BBVA BANCOMER, S.A. CTA. 0111374885 INGRESOS PROPIOS 2018	-72,698.14		0.00		-72,698.14	
11121021024003	BANCO SANTANDER CTA. 65506533736 FONDO GRAL. PARTICIPACION FEDERAL 2018	-99,251.15		40,000.01		-59,251.14	
11121021025	EJERCICIO 2018 (NVA ADMON)	1,961,941.50		123,297,094.33		1,246,208.89	
11121021025001	BANAMEX SA	1,886,621.16		11,833,529.06		1,246,208.89	
11121021025001001	CTA No 7013-8224706 INGRESOS PROPIOS 2018	1,430,508.43		4,005,471.78		1,246,208.89	
11121021025001002	CTA No 7013-8185956 GASTO CORRIENTE 2018	467,437.69		7,820,475.80		1,246,208.89	
11121021025001003	CTA No 7013-8185964 FAEISM 2018	675.66		7,561.48		1,246,208.89	
11121021025002	BBVA BANCOMER	63,320.34		111,463,565.27		1,246,208.89	
11121021025002002	CTA No 01-12600080 INGRESOS PROPIOS	63,320.34		111,463,565.27		1,246,208.89	
11121021026	EJERCICIO 2019	0.00		494,920,580.97		1,246,208.89	
11121021026002	BBVA BANCOMER	0.00		494,920,580.97		1,246,208.89	

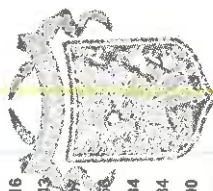
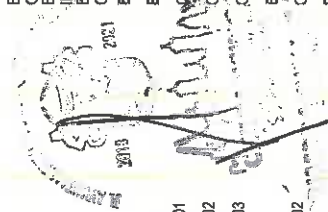



H. AYUNTAMIENTO MUNICIPAL DE CHILPANCINGO, GRO.

SECRETARIA DE FINANZAS Y ADMINISTRACION

CONSOLIDADO



BALANZA DE COMPROBACIÓN DEL 1 DE ENERO AL 31 DE DICIEMBRE DEL 2019

C U E N T A	C O N C E P T O	SALDOS INICIALES		MOVIMIENTOS		SALDOS ACUMULADOS	
		AL 1 DE ENERO DE 2019		ENERO - DICIEMBRE 2019		AL 31 DE DICIEMBRE DE 2019	
		DEBE	HABER	DEBE	HABER	DEBE	HABER
11121021026002001	CTA No 01-12626980 GASTO CORRIENTE 2019	0.00		467,012,696.73		465,766,501.14	1,246,195.59
11121021026002002	CTA No 01-12704692 INGRESOS PROPIOS	0.00		18,065,719.00		18,065,709.46	9.54
11121021026002003	CTA No 01-13704114 DEVOLUCIONES ISR.	0.00		9,842,165.24		9,842,161.68	3.56
11121022	FONDO DE APORT P/INFRA SOC MPAL	3,911.33		213,360,459.31		213,313,635.55	50,735.09
11121022021	EJERCICIO 2016	0.00		8.96		0.00	8.96
11121022021001	BANCOMER CTA No 0103581933 FAISM RAMO XXXIII 2016	0.00		8.96		0.00	8.96
11121022022	EJERCICIO 2017	0.00		4.56		0.00	4.56
11121022022002	BANCOMER CTA No 110331548 FAISM RAMO XXXIII 2017	0.00		4.56		0.00	4.56
11121022024	EJERCICIO 2018	0.00		694,467.69		694,348.31	119.38
11121022024001	BANCOMER CTA No 111346245 FISMDF RAMO XXXIII 2018	0.00		694,467.69		694,348.31	119.38
11121022025	EJERCICIO 2018 (NVA ADMON)	3,911.33		0.00		3,911.33	0.00
11121022025001	BANAMEX	3,911.33		0.00		3,911.33	0.00
11121022025001001	CTA: 7018185972 (FAISM RAMO XXXIII)	3,911.33		0.00		3,911.33	0.00
11121022026	EJERCICIO 2019	0.00		212,665,978.10		212,615,375.91	50,602.19
11121022026002	BANCOMER	0.00		212,665,978.10		212,615,375.91	50,602.19
11121022026002001	CTA: 01-12627388 (FAISM RAMO XXXIII)	0.00		212,665,978.10		212,615,375.91	50,602.19
11121023	FONDO DE AFORT P/FORT DE LO NIPOS	4,490,536.42		159,762.08		236,620,978.26	48,247.40
11121023024	EJERCICIO 2018	4,457,187.04		4,457,187.66		0.62	0.00
11121023024001	SANTANDER CTA 65506534043 FORTAMUN (SEG PUB) 2018	4,457,187.04		4,457,187.66		0.62	0.00
11121023025	EJERCICIO 2018 (NVA ADMON)	33,349.38		0.00		0.00	0.00
11121023025001	BANAMEX	33,349.38		0.00		0.00	0.00
11121023025001001	CTA: 70138224692 (FORTAMUN)	33,349.38		0.00		0.00	0.00
11121023025002	SANTANDER	58,941.32		4,324,169.00		4,217,980.13	47,247.55
11121023025002001	SANTANDER CTA: 65-50702469-4 (FORTAMUN)	58,941.32		4,324,169.00		4,217,980.13	47,247.55
11121023026	EJERCICIO 2019	25,591.94		0.00		25,591.94	0.00
11121023026003	BANCOMER	25,591.94		0.00		25,591.94	0.00
11121023026003001	BANCOMER CTA: 01-1262748-5 (FORTAMUN)	25,591.94		0.00		25,591.94	0.00
11121025	PROGRAMA DE HABITAT	0.00		232,378,405.42		232,377,405.57	999.85
11121025024	EJERCICIO 2018	0.00		232,378,405.42		232,377,405.57	999.85
11121025024001	SANTANDER CTA 65506580256 FORTASEG FEDERAL 2018	0.00		232,378,405.42		232,377,405.57	999.85
11121025024002	BANCOMER CTA 111449974 FORTASEG MUNICIPAL 2018	200,435.04		31,995,791.84		32,098,448.82	97,778.06
11121025026	EJERCICIO 2019	200,435.04		237,016.89		437,451.93	0.00
		0.00		237,009.80		437,444.84	0.00
		0.00		7.09		7.09	0.00
		0.00		31,759,774.95		31,660,996.89	97,778.06





H. AYUNTAMIENTO MUNICIPAL DE CHILPANCINGO, GRO.

SECRETARIA DE FINANZAS Y ADMINISTRACION

CONSOLIDADO



BALANZA DE COMPROBACIÓN DEL 1 DE ENERO AL 31 DE DICIEMBRE DEL 2019

C U E N T A	C O N C E P T O	SALDOS INICIALES		M O V I M I E N T O S		SALDOS ACUMULADOS	
		AL 1 DE ENERO DE 2019		ENERO - DICIEMBRE 2019		AL 31 DE DICIEMBRE DE 2019	
		DEBE	HABER	DEBE	HABER	DEBE	HABER
11121026026001	AFIRME 1851-21178 FORTASEG FEDERAL 2019	0.00		26,486,705.81	26,401,070.97	85,634.84	
11121026026002	AFIRME 1851-21186 FORTASEG (COPARTICIPACION) 2019	0.00		5,272,069.14	5,259,925.92	12,143.22	
11121026	FERTILIZANTE I.E.D.	66,645.88		0.00	0.00	66,645.88	
11121026024	EJERCICIO 2018	66,645.88		0.00	0.00	66,645.88	
11121026024001	SCOTTABANK CTA No 04401104772 FERTILIZANTE IED 2018	66,645.88		0.00	0.00	66,645.88	
11121027	FORTALECE	1,723.15		0.85	1,724.00	0.00	
11121027022	EJERCICIO 2017	1,723.15		0.85	1,724.00	0.00	
11121027022001	BANCOMER CTA No 110693235 PROGRAMA FORTALECE 2017	1,723.15		0.85	1,724.00	0.00	
11121028	RESCATE DE ESPACIOS PUBLICOS	562.94		0.00	1,724.00	0.00	
11121028023	EJERCICIO 2018	562.94		0.00	0.00	562.94	
11121028023001	BANCOMER CTA No 111049888 PROG ESPACIOS PUBLICOS 2017	562.94		0.00	0.00	562.94	
11121030	PROG FINANMIENTO FINANCIERO PIINVERSION RAMO 23	1,540,962.50		101.73	1,530,517.25	10,546.98	
11121030021	EJERCICIO 2016	832.87		0.12	0.00	832.99	
11121030021001	BANCOMER CTA 0109628428 PROG FINAM FINAN P/INVERSION RAMO 23	832.87		0.12	0.00	832.99	
11121030024	EJERCICIO 2018	1,540,129.63		101.61	1,530,517.25	9,713.99	
11121030024001	BANCOMER CTA 0111843176 PROG RAMO 23 FORTALECIMIENTO FINANCIERO 2018	1,540,129.63		101.61	1,530,517.25	9,713.99	
11121032	PROGRAMA PRODDER-CONAGUA	0.00		6,615,112.20	16,242,735.46	1,201,439.00	
11121032026	EJERCICIO 2019	0.00		6,615,112.20	16,242,735.46	0.00	
11121032026001	BANCOMER CTA: 0111530887 PROGRAMA PRODDER	0.00		6,615,112.20	16,242,735.46	0.00	
11121040	FAEISM	0.00		16,242,735.46	16,242,735.46	0.00	
11121040028	INGRESOS 2019	0.00		16,242,735.46	16,242,735.46	0.00	
11121040028001	BANCOMER	0.00		16,242,735.46	16,242,735.46	0.00	
11121040028001001	CTA: 0112627140	0.00		16,242,735.46	16,242,735.46	0.00	
1116	DEPOSITOS DE FONDOS DE TERCEROS EN GARANTIA Y/O ADMINISTRACION	0.00		16,242,735.46	16,242,735.46	0.00	
11161	DEPOSITOS EN GARANTIA	28,000.00		0.00	0.00	28,000.00	
11161021	EJERCICIO 2016	28,000.00		0.00	0.00	28,000.00	
11161021021	ELIA DE LA O GALLARDO	28,000.00		0.00	0.00	28,000.00	
11161021021001	LUIS ALBERTO PATRON OSORIO	15,000.00		0.00	0.00	15,000.00	
11161021021002	DERECHOS A RECIBIR EFECTIVO O EQUIVALENTES	13,000.00		0.00	0.00	13,000.00	
112		209,307,225.92		1,204,011,785.86	1,129,989,657.00	284,730,354.78	

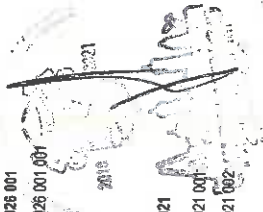
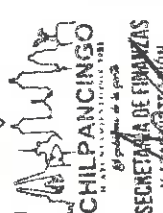





H. AYUNTAMIENTO MUNICIPAL DE CHILPANCINGO, GRO.

SECRETARIA DE FINANZAS Y ADMINISTRACION

CONSOLIDADO



BALANZA DE COMPROBACION DEL 1 DE ENERO AL 31 DE DICIEMBRE DEL 2019

C U E N T A	C O N C E P T O	SALDOS INICIALES		M O V I M I E N T O S				SALDOS ACUMULADOS	
		AL 1 DE ENERO DE 2019		ENERO - DICIEMBRE 2019		AL 31 DE DICIEMBRE DE 2019			
		DEBE	HABER	DEBE	HABER	DEBE	HABER	DEBE	HABER
1122	CUENTAS POR COBRAR A CORTO PLAZO	1,267,620.95		778,455,991.75	777,289,619.17			2,433,993.53	
11225	CUENTAS POR COBRAR A LA FEDERACION	1,188,079.55		776,450,491.75	775,389,919.17			2,248,652.13	
11225 021	GASTO CORRIENTE	848,884.43		349,859,337.28	349,289,875.06			1,416,346.66	
11225 021 023	EJERCICIO 2017 (OCT-DIC NVA ADMON)	0.00		337,725,221.10	337,725,221.10			0.00	
11225 021 023 002	PARTICIPACIONES FEDERALES	0.00		337,725,221.10	337,725,221.10			0.00	
11225 021 024	EJERCICIO 2018	691,035.55		11,540,000.00	11,540,000.00			691,035.55	
11225 021 024 001	SUBSIDIO AL EMPLEO	691,035.55		0.00	0.00			691,035.55	
11225 021 024 002	PARTICIPACIONES FEDERALES	0.00		11,540,000.00	11,540,000.00			0.00	
11225 021 025	EJERCICIO 2018 (NVA ADMINISTRACION)	155,848.88		0.00	0.00			155,848.88	
11225 021 025 001	SUBSIDIO AL EMPLEO	155,848.88		0.00	0.00			155,848.88	
11225 021 026	EJERCICIO 2019	0.00		0.00	0.00			0.00	
11225 021 026 001	SUBSIDIO AL EMPLEO	0.00		594,116.19	24,653.96			569,462.23	
11225 022	FONDO DE APORT P/INFRA SOC MPAL	0.00		594,116.19	24,653.96			569,462.23	
11225 022 024	EJERCICIO 2018	0.00		210,132,906.39	210,132,906.39			0.00	
11225 022 024 001	FONDOS DE APORTACIONES FEDERALES FISM DF	0.00		210,132,906.39	210,132,906.39			0.00	
11225 023	FONDO DE APORT P/FORT DE LOS MIPOS	141,195.12		186,892,691.85	186,501,481.50			832,305.47	
11225 023 024	EJERCICIO 2018	220,934.39		186,449,303.00	186,449,303.00			220,934.39	
11225 023 024 001	SUBSIDIO AL EMPLEO	0.00		0.00	0.00			0.00	
11225 023 024 002	FONDO DE APORTACIONES FEDERALES	0.00		186,449,303.00	186,449,303.00			0.00	
11225 023 025	EJERCICIO 2018 NUEVA ADMINISTRACION	120,260.73		0.00	0.00			120,260.73	
11225 023 026	SUBSIDIO AL EMPLEO	120,260.73		0.00	0.00			120,260.73	
11225 023 026 001	EJERCICIO 2019	0.00		0.00	0.00			0.00	
11225 023 026 002	SUBSIDIO AL EMPLEO	0.00		343,288.85	35,318.91			507,969.94	
11225 025	FORTASEG	0.00		543,288.85	35,318.91			507,969.94	
11225 025 026	EJERCICIO 2019	0.00		26,357,134.48	26,357,134.48			0.00	
11225 025 026 008	PROGRAMA FORTASEG	0.00		26,357,134.48	26,357,134.48			0.00	
11225 027	FORTALECE	0.00		26,357,134.48	26,357,134.48			0.00	
11225 027 026	EJERCICIO 2019	0.00		0.10	0.10			0.00	
11225 027 026 001	APORTACION FEDERAL DEL PROGRAMA FORTALECE RAMO 23 2017	0.00		0.10	0.10			0.00	
11225 030	PROG FORTALECIM FINANCIERO P/INVERSION RAMO 23	0.00		101.64	101.64			0.00	
11225 030 026	EJERCICIO 2019	0.00		101.64	101.64			0.00	
11225 030 026 001	CONVENIOS FEDERALES	0.00		101.64	101.64			0.00	

SECRETARIA DE FINANZAS Y ADMINISTRACION  
 H. AYUNTAMIENTO MUNICIPAL DE CHILPANCINGO, GRO.  
 2019

SECRETARIA DE FINANZAS Y ADMINISTRACION  
 H. AYUNTAMIENTO MUNICIPAL DE CHILPANCINGO, GRO.  
 2019

H. Ayuntamiento Municipal Constitucional de Chilpancingo, Gro.

miércoles 25 marzo 2020

6.08.08 PM

Coram/ Balanza



H. AYUNTAMIENTO MUNICIPAL DE CHILPANCINGO, GRO.

SECRETARIA DE FINANZAS Y ADMINISTRACION

CONSOLIDADO



BALANZA DE COMPROBACIÓN DEL 1 DE ENERO AL 31 DE DICIEMBRE DEL 2019

C U E N T A	C O N C E P T O	SALDOS INICIALES		M O V I M I E N T O S		SALDOS ACUMULADOS	
		AL 1 DE ENERO DE 2019		ENERO - DICIEMBRE 2019		AL 31 DE DICIEMBRE DE 2019	
		DEBE	HABER	DEBE	HABER	DEBE	HABER
11225 032	PROGRAMA PRODDER	0.00		3,108,420.00	3,108,420.00	0.00	0.00
11225 032 026	EJERCICIO 2019	0.00		3,108,420.00	3,108,420.00	0.00	0.00
11225 032 026 001	CONVENIOS FEDERALES	0.00		3,108,420.00	3,108,420.00	0.00	0.00
11226	CUENTAS POR COBRAR A ENTIDADES FEDERATIVAS Y MUNICIPIOS	0.00		1,500,000.00	1,500,000.00	0.00	0.00
11229	OTRAS CUENTAS POR COBRAR	79,541.40		505,500.00	399,700.00	185,341.40	
11229 021	GASTO CORRIENTE	65,000.00		358,000.00	276,500.00	146,500.00	
11229 021 024	EJERCICIO 2018	35,000.00		0.00	0.00	35,000.00	
11229 021 024 001	YURIANA IBAÑERA BUENROSTRO	5,000.00		0.00	0.00	5,000.00	
11229 021 024 002	JOSE LUIS PEREZ GARCIA	15,000.00		0.00	0.00	15,000.00	
11229 021 024 003	BERIBERTO GONZALEZ VICTORINO	15,000.00		0.00	0.00	15,000.00	
11229 021 025	EJERCICIO 2018 NUEVA ADMINISTRACION OCT- DICI	30,000.00		0.00	0.00	15,000.00	
11229 021 025 001	ADOLFO CALDERON NAVA	30,000.00		0.00	30,000.00	0.00	0.00
11229 021 026	EJERCICIO 2019 NUEVA ADMINISTRACION	0.00		0.00	30,000.00	0.00	0.00
11229 021 026 001	REYNA ALARCON FLORES	0.00		358,000.00	246,500.00	111,500.00	
11229 021 026 002	SANDRA MAGALI BELLO LEYVA	0.00		24,000.00	24,000.00	0.00	0.00
11229 021 026 003	ANGEL URBINO PALACIOS GONZALEZ	0.00		10,000.00	10,000.00	0.00	0.00
11229 021 026 005	MARIA DE LOS ANGELES VAZQUEZ PASTOR	0.00		20,500.00	20,500.00	0.00	0.00
11229 021 026 006	EFREN ENCARNAION NAVA	0.00		12,000.00	10,500.00	1,500.00	
11229 021 026 007	ANA LILIA LEYVA SOTELO	0.00		25,000.00	21,000.00	4,000.00	
11229 021 026 008	MA. ISABEL DIAZ LEON	0.00		25,000.00	25,000.00	0.00	0.00
11229 021 026 009	GUDELIA ORTIZ GONZALEZ	0.00		5,000.00	5,000.00	0.00	0.00
11229 021 026 010	JOSE VIDAL LAUREANO ORBE	0.00		5,000.00	5,000.00	0.00	0.00
11229 021 026 011	ERNESTO ANDRADE TALavera	0.00		10,000.00	8,500.00	1,500.00	
11229 021 026 012	MARLEN ROMERO DIAZ	0.00		6,500.00	6,500.00	0.00	0.00
11229 021 026 015	MARISOL CUEVAS SERRANO	0.00		20,000.00	11,500.00	8,500.00	
11229 021 026 016	ARTURO GACHUZ CERECERO	0.00		10,000.00	7,000.00	3,000.00	
11229 021 026 017	JORGE CASTAÑON JUAREZ	0.00		10,000.00	10,000.00	0.00	0.00
11229 021 026 019	TEODORA CASTRO CASARRUBIAS	0.00		10,000.00	8,000.00	2,000.00	
11229 021 026 021	JUAN JOSE SALAZAR HERNANDEZ	0.00		10,000.00	10,000.00	0.00	0.00
11229 021 026 022	ROSALIO RAMIREZ CASTRO	0.00		10,000.00	10,000.00	0.00	0.00
11229 021 026 023	LUIS VELEZ NAVA	0.00		10,000.00	10,000.00	0.00	0.00

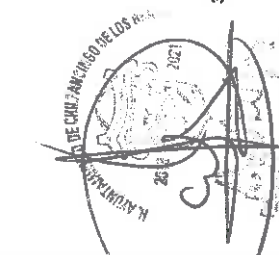

PRESIDENCIA



M. Ayuntamiento Municipal Constitucional de Chilpancingo, Gro. CONTRALORIA INTERNA MUNICIPAL



H. AYUNTAMIENTO MUNICIPAL DE CHILPANCINGO, GRO.

SECRETARIA DE FINANZAS Y ADMINISTRACION

CONSOLIDADO



BALANZA DE COMPROBACION DEL 1 DE ENERO AL 31 DE DICIEMBRE DEL 2019

C U E N T A	C O N C E P T O	SALDOS INICIALES		MOVIMIENTOS		SALDOS ACUMULADOS	
		AL 1 DE ENERO DE 2019		ENERO - DICIEMBRE 2019		AL 31 DE DICIEMBRE DE 2019	
		DEBE	HABER	DEBE	HABER	DEBE	HABER
11229021026024	SAMUEL MOTEZUMA MORENO	0.00		10,000.00		10,000.00	0.00
11229021026025	ANTONIO TOLENTINO MILLAN	0.00		10,000.00		7,000.00	3,000.00
11229021026026	JOSE ROBERTO FLORES LEYVA	0.00		15,000.00		3,500.00	11,500.00
11229021026027	JUAN PABLO LOPEZ MADRIGAL	0.00		10,000.00		3,500.00	6,500.00
11229021026029	TOBIAS BAUTISTA MIRANDA	0.00		10,000.00		10,000.00	0.00
11229021026030	BLANCA ALICIA CAMACHO DE LA CRUZ	0.00		50,000.00		0.00	50,000.00
11229021026031	ERIKA YOLIZETH PEÑA GUTIERREZ	0.00		5,000.00		0.00	5,000.00
11229021026032	RAMIRO MERCADO BLANCO	0.00		15,000.00		0.00	15,000.00
11229023	FONDO DE APORT P/FORT DE LOS MPIOS	14,541.40		147,500.00		123,200.00	38,841.40
11229023023	EJERCICIO 2017 (OCT-DIC)	-2,125.10		0.00		0.00	-2,125.10
112290230230231	OCTAVIO MIRANDA MORA	-2,125.10		0.00		0.00	-2,125.10
11229023024	EJERCICIO 2018	18,166.50		0.00		0.00	18,166.50
11229023024003	JOSE LUIS CHAVEZ ADAME	20,000.00		0.00		0.00	20,000.00
11229023024004	ANTONIO TOLENTINO MILLAN	-833.50		0.00		0.00	-833.50
11229023025	EJERCICIO 2019	-2,500.00		13,500.00		11,000.00	0.00
11229023025001	EJERCICIO 2018 NUEVA ADMINISTRACION	-2,500.00		13,500.00		11,000.00	0.00
1122902302500101	MATIAS AREVAS HERAS	0.00		134,000.00		112,200.00	21,800.00
112290230250010101	EJERCICIO 2019	0.00		8,000.00		8,000.00	0.00
11229023025001010101	ERNESTO ANDRADE TALAVERA	0.00		10,000.00		8,500.00	1,500.00
1122902302500101010101	LEIDY GARCIA CORTEZ	0.00		10,000.00		8,000.00	2,000.00
112290230250010101010101	RUFINA IGNACIO DIAZ	0.00		10,000.00		8,000.00	2,000.00
11229023025001010101010101	ISRAEL PEREZ JIMENEZ	0.00		15,000.00		11,200.00	3,800.00
1122902302500101010101010101	FERNANDO DE JESUS ROMERO	0.00		10,000.00		7,500.00	2,500.00
112290230250010101010101010101	MARIO NAVA MARTINEZ	0.00		10,000.00		7,500.00	2,500.00
11229023026007	ARTURO PELAGIO ANGON	0.00		10,000.00		10,000.00	0.00
11229023026008	JUAN JOSE SALAZAR HERNANDEZ	0.00		10,000.00		10,000.00	0.00
11229023026009	EMILIO CRUZ PACHECO	0.00		10,000.00		10,000.00	0.00
11229023026010	ANASTACIO MONTIEL MATA	0.00		5,000.00		5,000.00	0.00
11229023026011	ROSALIO RAMIREZ CASTRO	0.00		10,000.00		6,500.00	3,500.00
11229023026012	PEDRO CASTRO FAUSTINO	0.00		10,000.00		6,000.00	4,000.00
11229023026013	ANTONIO TOLENTINO MILLAN	0.00		10,000.00		10,000.00	0.00
11229023026014	PEDRO MORENO CRESPO	0.00		6,000.00		6,000.00	0.00
1123	DEUDORES DIVERSOS POR COBRAR A CORTO PLAZO	186,196,186.94		199,774,578.39		125,500,432.50	270,476,332.83

SECRETARIA DE FINANZAS Y ADMINISTRACION  
 M. AYUNTAMIENTO MUNICIPAL DE CHILPANCINGO, GRO.  
 2019

SECRETARIA DE FINANZAS Y ADMINISTRACION  
 M. AYUNTAMIENTO MUNICIPAL DE CHILPANCINGO, GRO.  
 2019



M. Ayuntamiento Municipal Constitucional de Chilpancingo, Gro. Contraloría Municipal



H. AYUNTAMIENTO MUNICIPAL DE CHILPANCINGO, GRO.

SECRETARIA DE FINANZAS Y ADMINISTRACION

CONSOLIDADO



BALANZA DE COMPROBACION DEL 1 DE ENERO AL 31 DE DICIEMBRE DEL 2019

C U E N T A	C O N C E P T O	SALDOS INICIALES		MOVIMIENTOS		SALDOS ACUMULADOS	
		AL 1 DE ENERO DE 2019		ENERO - DICIEMBRE 2019		AL 31 DE DICIEMBRE DE 2019	
		DEBE	HABER	DEBE	HABER	DEBE	HABER
11239	OTROS DEUDORES DIVERSOS POR COBRAR A CORTO PLAZO (DEUDORES DIVERSOS)	195,195,186.94		199,774,578.39	125,500,432.50	270,470,332.83	
11239 021	GASTO CORRIENTE	44,296,853.36		64,673,991.58	62,859,639.54	46,111,205.40	
11239 021 022	EJERCICIO 2017	30,673,582.63		0.00	0.00	30,673,582.63	
11239 021 022 003	C.A.P.A.C.H.	30,673,582.63		0.00	0.00	30,673,582.63	
11239 021 023	EJERCICIO 2017 (OCT-DIC NVA ADMON)	8,158,594.14		0.00	0.00	8,158,594.14	
11239 021 023 003	C.A.P.A.C.H.	8,158,594.14		0.00	0.00	8,158,594.14	
11239 021 024	EJERCICIO 2018	330,125.53		0.17	330,125.53	0.17	
11239 021 024 011	DIFERENCIA EN PAGO DE CHEQUES	501.87		0.00	501.87	0.00	
11239 021 024 012	FORTASEG (COPARTICIPACION)	329,623.66		0.17	329,623.66	0.17	
11239 021 025	EJERCICIO 2018 NVA. ADMINISTRACION	5,134,551.06		617,974.00	2,248,103.72	3,504,421.34	
11239 021 025 003	C.A.P.A.C.H.	5,504,421.34		617,974.00	617,974.00	3,504,421.34	
11239 021 025 005	FONDO DE AHORRO	1,620,182.40		0.00	1,620,182.40	0.00	
11239 021 025 100	OTROS DEUDORES	9,947.32		0.00	9,947.32	0.00	
11239 021 025 100 045	NOMINA	9,947.32		0.00	9,947.32	0.00	
11239 021 026	EJERCICIO 2019	0.00		64,056,017.41	60,281,410.29	3,774,607.12	
11239 021 026 003	C.A.P.A.C.H.	0.00		16,629,708.14	16,629,708.14	0.00	
11239 021 026 004	SECRETARIA DE FINANZAS (ISSSTE)	0.00		12,576,634.80	12,576,634.80	0.00	
11239 021 026 005	FONDO DE A-HORRO	0.00		20,858,057.22	18,546,708.95	2,111,348.27	
11239 021 026 006	FONSOL	0.00		1,661,825.00	0.00	1,661,825.00	
11239 021 026 007	PRESTAMO PARA CONTINGENCIAS FINANCIERAS	0.00		1,500,000.00	1,500,000.00	0.00	
11239 021 026 008	JOSE VELEZ MEMIJE	0.00		10,000.00	10,000.00	0.00	
11239 021 026 010	DESCUENTOS POR CUENTA DE CAPACH ( IMSS E ISR)	0.00		5,270,437.60	5,270,437.60	0.00	
11239 021 026 011	CECILIA NAVARRETE HERNANDEZ	0.00		21,000.00	21,000.00	0.00	
11239 021 026 012	HIGLABI GARCIA RAMOS	0.00		42,000.00	42,000.00	0.00	
11239 021 026 013	MIGUEL ANGEL CASARRUBIAS REYES	0.00		42,000.00	42,000.00	0.00	
11239 021 026 014	PABLO ALCALA RODRIGUEZ	0.00		24,000.00	24,000.00	0.00	
11239 021 026 015	JOSE ROGERIO CUEVAS ESTRADA	0.00		42,000.00	42,000.00	0.00	
11239 021 026 016	JOSE LUIS ALCALA RODRIGUEZ	0.00		24,000.00	24,000.00	0.00	

SECRETARIA DE FINANZAS Y ADMINISTRACION  
 H. AYUNTAMIENTO MUNICIPAL DE CHILPANCINGO, GRO.  
 2019



CONTRALORIA INTERNA MUNICIPAL  
 24,000.00





H. AYUNTAMIENTO MUNICIPAL DE CHILPANCINGO, GRO.



SECRETARIA DE FINANZAS Y ADMINISTRACION

CONSOLIDADO

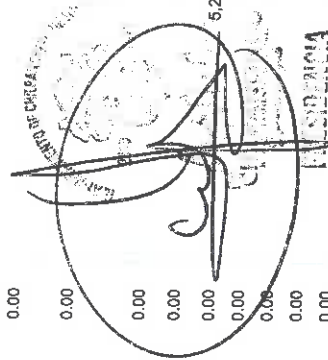

BALANZA DE COMPROBACION DEL 1 DE ENERO AL 31 DE DICIEMBRE DEL 2019

C U E N T A	C O N C E P T O	SALDOS INICIALES		M O V I M I E N T O S		SALDOS ACUMULADOS	
		AL 1 DE ENERO DE 2019		ENERO - DICIEMBRE 2019		AL 31 DE DICIEMBRE DE 2019	
		DEBE	HABER	DEBE	HABER	DEBE	HABER
11239021026017	ISABEL LOMITAS BERNABE	0.00		30,000.00		30,000.00	0.00
11239021026018	JULIO CESAR DIAZ LOPEZ	0.00		35,000.00		35,000.00	0.00
11239021026020	KRISTELL SOTELO ESTEBAN	0.00		5,000.00		5,000.00	0.00
11239021026021	LEONARDO DANIEL VALENZUELA CERVANTES	0.00		5,500.00		5,500.00	0.00
11239021026022	YOANDI VEGA SOLANO	0.00		4,500.00		4,500.00	0.00
11239021026023	YOANDI VEGA SOLANO	0.00		2,500.00		2,500.00	0.00
11239021026024	FEDERICO GONZALEZ CUENCA	0.00			105.00	105.00	0.00
11239021026025	ISRAEL PEREZ JIMENEZ	0.00			10,000.00	10,000.00	0.00
11239021026026	FORTASEG (COPARTICIPACION)	0.00		5,251,941.80		5,251,941.80	0.00
11239021026027	MARIO NAVA MARTINEZ	0.00			10,000.00	10,000.00	0.00
11239021026028	EMILIO CRUZ PACHECO	0.00			10,000.00	10,000.00	0.00
11239021026029	ANASTASIO MONTIEL MATA	0.00			5,000.00	5,000.00	0.00
11239021026030	LEIDY GARCIA CORTEZ	0.00			10,000.00	10,000.00	0.00
11239021026031	ARTURO PELAGIO ANSON	0.00			10,000.00	10,000.00	0.00
11239021026032	INVICH AUTOCONSTRUCCION 2019	0.00			41,760.00	41,760.00	0.00
11239021026033	INVICH TENENCIA DE LA TIERRA 2019	0.00			70,544.00	70,544.00	0.00
11239021026034	PEDRO MORENO CRESPO	0.00			6,000.00	6,000.00	0.00
11239021026035	MAGDALENA MONTOR DIAZ	0.00			5,000.00	5,000.00	0.00
11239021026037	ANGEL FELIPE PEREZ ARAUJO	0.00			30,000.00	30,000.00	0.00
11239021026038	JOSE FRANCISCO GARCIA GONZALEZ	0.00			10,000.00	10,000.00	0.00
11239021026039	JUAN MANUEL MORALES ALVAREZ	0.00			70.00	70.00	0.00
11239021026040	REYNA ALARCON FLORES	0.00			1,433.85	1,433.85	0.00
11239022	FONDO DE APORT PIINFRA SOC MPAL	107,259,954.47		17,488,164.85		124,747,119.32	1,433.85
1123902202	EJERCICIO 2017	94,104,071.50		0.00		94,104,071.50	0.00
1123902202001	GASTO CORRIENTE	88,254,071.50		0.00		88,254,071.50	0.00
1123902202002	FORTAMUN (SEGURIDAD PUBLICA)	5,850,000.00		0.00		5,850,000.00	0.00



H. AYUNTAMIENTO MUNICIPAL DE CHILPANCINGO, GRO.

SECRETARIA DE FINANZAS Y ADMINISTRACION

CONSOLIDADO

BALANZA DE COMPROBACION DEL 1 DE ENERO AL 31 DE DICIEMBRE DEL 2019

C U E N T A	C O N C E P T O	SALDOS INICIALES		MOVIMIENTOS		SALDOS ACUMULADOS	
		AL 1 DE ENERO DE 2019		ENERO - DICIEMBRE 2019		AL 31 DE DICIEMBRE DE 2019	
		DEBE	HABER	DEBE	HABER	DEBE	HABER
11239 022 023	EJERCICIO 2017 (OCT-DIC NVA ADMON)		163,149.39		0.00		163,149.39
11239 022 023 002	FORTAMUN (SEGURIDAD PUBLICA)		163,149.39		0.00		163,149.39
11239 022 024	EJERCICIO 2018						
11239 022 024 001	GASTO CORRIENTE	12,991,733.58		0.00	0.00		12,991,733.58
11239 022 026	EJERCICIO 2019						
11239 022 026 001	GASTO CORRIENTE	0.00		17,488,164.85	0.00		17,488,164.85
11239 023	FONDO DE APORT PIFORT DE LOS MPIOIS						
11239 023 022	EJERCICIO 2017	31,148,372.14		82,587,861.17	55,765,638.43		57,970,594.88
11239 023 022 001	GASTO CORRIENTE	13,636,536.90		0.00	0.00		13,636,536.90
11239 023 022 003	FORTASEG	10,781,024.18		0.00	0.00		10,781,024.18
11239 023 023	EJERCICIO 2017 (OCT-DIC NVA ADMON)	2,855,512.72		0.00	0.00		2,855,512.72
11239 023 023 001	GASTO CORRIENTE	2,417,994.74		0.00	0.00		2,417,994.74
11239 023 024	EJERCICIO 2018	2,417,994.74		0.00	0.00		2,417,994.74
11239 023 024 001	GASTO CORRIENTE	5,080,945.91		0.00	0.00		5,080,945.91
11239 023 025	EJERCICIO 2018 NUEVA ADMINISTRACION	5,080,945.91		0.00	0.00		5,080,945.91
11239 023 025 001	GASTO CORRIENTE	10,012,994.58		617,374.00	10,630,868.59		5,080,945.91
11239 023 025 002	CAPACH	9,365,488.83		617,974.00	9,983,462.83		0.00
11239 023 025 003	DIFERENCIA EN CHEQUES	600,000.00		0.00	600,000.00		0.00
11239 023 025 006	NOMINA	0.96		0.00	0.96		0.00
11239 023 026	EJERCICIO 2019	47,404.80		0.00	47,404.80		0.00
11239 023 026 001	GASTO CORRIENTE	0.00		81,969,887.17	45,134,769.84		36,835,117.33
11239 023 026 003	INGRESOS PROPIOS	0.00		76,038,266.40	39,203,149.07		36,835,117.33
11239 023 026 004	CAPACH	0.00		1,647,277.18	1,647,277.18		0.00
11239 025	FORTASEG	0.00		4,284,343.59	4,284,343.59		0.00
11239 025 022	EJERCICIO 2017	6,135,833.00		0.00	237,000.00		5,898,833.00
11239 025 022 002	GASTO CORRIENTE	5,898,833.00		0.00	0.00		5,898,833.00
11239 025 025	EJERCICIO 2018 ADMINISTRACION 2018-2021	5,898,833.00		0.00	0.00		5,898,833.00
11239 025 025 001	GASTO CORRIENTE	237,000.00		0.00	237,000.00		0.00
11239 027	FORTALECE	237,000.00		0.00	237,000.00		0.00
11239 027 021	EJERCICIO 2016	4,078,639.62		0.00	45.24		4,078,639.62
11239 027 021 001	GASTO CORRIENTE	1,828,639.62		0.00	0.00		1,828,639.62
11239 027 021 002	SEGURIDAD PUBLICA	982,677.07		0.00	0.00		982,677.07
		845,962.55		0.00	0.00		845,962.55

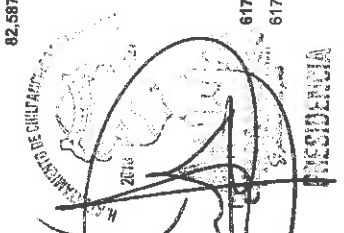



H. AYUNTAMIENTO MUNICIPAL DE CHILPANCINGO, GRO.

SECRETARIA DE FINANZAS Y ADMINISTRACION

CONSOLIDADO



BALANZA DE COMPROBACIÓN DEL 1 DE ENERO AL 31 DE DICIEMBRE DEL 2019

C U E N T A	C O N C E P T O	SALDOS INICIALES		MOVIMIENTOS		SALDOS ACUMULADOS	
		AL 1 DE ENERO DE 2019		ENERO - DICIEMBRE 2019		AL 31 DE DICIEMBRE DE 2019	
		DEBE	HABER	DEBE	HABER	DEBE	HABER
11239 027 022	EJERCICIO 2017	2,250,000.00		0.00		0.00	2,250,000.00
11239 027 022 001	PROGRAMA FAISM RAMO XXXIII	2,250,000.00		0.00		0.00	2,250,000.00
11239 027 024	EJERCICIO 2018	45.24		0.00	45.24	45.24	0.00
11239 027 024 001	PROGRAMA GASTO CORRIENTE	45.24		0.00	45.24	45.24	0.00
11239 030	PROG FORTALECIMIENTO FINANCIERO P/INVERSION RAMO 23	1,388,728.04		0.00		0.00	1,388,728.04
11239 030 021	EJERCICIO 2016	1,374,630.96		0.00		0.00	1,374,630.96
11239 030 021 001	GASTO CORRIENTE	1,374,630.96		0.00		0.00	1,374,630.96
11239 030 022	EJERCICIO 2017	14,059.96		0.00		0.00	14,059.96
11239 030 022 001	PROG. FAFEF (RELLENO SANITARIO)	14,059.96		0.00		0.00	14,059.96
11239 030 024	EJERCICIO 2018	37.12		0.00		0.00	37.12
11239 030 024 001	PROGRAMA DE GASTO CORRIENTE	37.12		0.00		0.00	37.12
11239 032	PROGRAMA PRODDER-CONAGUA	1,848,863.49		2,060,000.00	2,060,000.00	0.00	1,848,863.49
11239 032 022	EJERCICIO 2017	1,120,538.00		0.00		0.00	1,120,538.00
11239 032 022 002	CAPACH	1,120,538.00		0.00		0.00	1,120,538.00
11239 032 024	EJERCICIO 2018	728,325.49		0.00		0.00	728,325.49
11239 032 024 001	CAPACH	728,325.49		0.00		0.00	728,325.49
11239 032 026	EJERCICIO 2019	0.00		0.00		0.00	0.00
11239 032 026 001	GASTO CORRIENTE	0.00		0.00		0.00	0.00
11239 032 026 002	CAPACH	0.00		0.00		0.00	0.00
11239 033	PROG. FAFEF (RELLENO SANITARIO)	39,897.58		0.00		0.00	39,897.58
11239 033 021	EJERCICIO 2016	39,897.58		0.00		0.00	39,897.58
11239 033 021 001	GASTO CORRIENTE	39,897.58		0.00		0.00	39,897.58
11239 040	FAEISM	0.00		0.00		0.00	0.00
11239 040 026	PRODDER (PRESTAMOS)	0.00		5,871,385.56	5,871,385.56	5,871,385.56	0.00
11239 040 026 001	GASTO CORRIENTE (PRESTAMOS)	0.00		5,871,385.56	5,871,385.56	5,871,385.56	0.00
11239 040 026 002	INGRESOS PROPIOS	0.00		686,692.20	686,692.20	686,692.20	0.00
11239 041	EJERCICIO 2019	0.00		5,184,693.36	5,184,693.36	5,184,693.36	0.00
11239 041 026	GASTO CORRIENTE	0.00		27,093,175.23	27,093,175.23	27,093,175.23	0.00
11239 041 026 001	SEGURIDAD PÚBLICA	0.00		22,675,418.96	22,675,418.96	22,675,418.96	0.00
11239 041 026 002	FAEISM	0.00		4,142,540.64	4,142,540.64	4,142,540.64	0.00
11239 041 026 004	INGRESOS POR RECUPERAR A CORTO PLAZO	0.00		275,215.63	275,215.63	275,215.63	0.00
1124		0.00		145,517,842.38	145,517,842.38	145,517,842.38	0.00

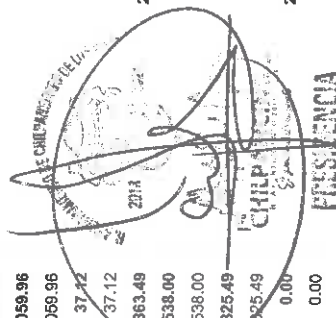

Ayuntamiento Municipal Constitucional de  
CONTRALORIA INTERNA MUNICIPAL



H. AYUNTAMIENTO MUNICIPAL DE CHILPANCINGO, GRO.

SECRETARIA DE FINANZAS Y ADMINISTRACION

CONSOLIDADO



BALANZA DE COMPROBACIÓN DEL 1 DE ENERO AL 31 DE DICIEMBRE DEL 2019

C U E N T A	C O N C E P T O	SALDOS INICIALES		M O V I M I E N T O S		SALDOS ACUMULADOS	
		AL 1 DE ENERO DE 2019		ENERO - DICIEMBRE 2019		AL 31 DE DICIEMBRE DE 2019	
		DEBE	HABER	DEBE	HABER	DEBE	HABER
11241	CONTRIBUCIONES POR COBRAR	0.00		108,580,184.96		108,580,184.96	0.00
11241021	GASTO CORRIENTE	0.00		108,580,184.96		108,580,184.96	0.00
11241021023	EJERCICIO 2017 (OCT-DIC NVA ADMON)	0.00		108,580,184.96		108,580,184.96	0.00
11241021023001	IMPUESTOS SOBRE INGRESOS	0.00		5,550.00		5,550.00	0.00
11241021023002	IMPUESTO SOBRE EL PATRIMONIO	0.00		72,982,144.93		72,982,144.93	0.00
11241021023003	ACCESORIOS DE IMPUESTOS	0.00		955,359.00		955,359.00	0.00
11241021023004	OTROS IMPUESTOS	0.00		34,637,131.03		34,637,131.03	0.00
11242	CONTRIBUCIONES DE MEJORAS POR COBRAR	0.00		30,941,601.51		30,941,601.51	0.00
11242021	GASTO CORRIENTE	0.00		30,941,601.51		30,941,601.51	0.00
11242021023	EJERCICIO 2017 (OCT-DIC NVA ADMON)	0.00		30,941,601.51		30,941,601.51	0.00
11242021023001	DERECHOS POR EL USO O APROVECHAMIENTO O EXPLOTACION DE BIENES DE DOMINIO PUBLICO	0.00		5,728,394.53		5,728,394.53	0.00
11242021023002	DERECHOS POR PRESTACION DE SERVICIOS	0.00		23,987,880.65		23,987,880.65	0.00
11242021023003	OTROS DERECHOS	0.00		1,225,296.33		1,225,296.33	0.00
11242021023004	ACCESORIOS	0.00		30.00		30.00	0.00
11243	DERECHOS POR COBRAR	0.00		923,012.76		923,012.76	0.00
11243001	FONDO GENERAL DE PARTICIPACIONES	0.00		3,517.00		3,517.00	0.00
11243003	FONDO DE APORT PIFORT DE LOS MPIO	0.00		642.05		642.05	0.00
11243003004	ADMION 2009-2012	0.00		642.05		642.05	0.00
11243003004001	PRODUCTOS DE TIPO CORRIENTE	0.00		642.05		642.05	0.00
11243021	GASTO CORRIENTE	0.00		918,853.71		918,853.71	0.00
11243021022	EJERCICIO 2017	0.00		43,109.00		43,109.00	0.00
11243021022001	PRODUCTOS DE TIPO CORRIENTE	0.00		43,109.00		43,109.00	0.00
11243021023	EJERCICIO 2017 (OCT-DIC NVA ADMON)	0.00		784,337.71		784,337.71	0.00
11243021023001	PRODUCTOS DE TIPO CORRIENTE	0.00		784,337.71		784,337.71	0.00
11243021026	EJERCICIO 2019	0.00		91,407.00		91,407.00	0.00
11243021026001	PRODUCTOS TIPO CORRIENTE	0.00		91,407.00		91,407.00	0.00
11244	PRODUCTOS POR COBRAR	0.00		1,437,456.65		1,437,456.65	0.00
11244021	GASTO CORRIENTE	0.00		1,031,279.71		1,031,279.71	0.00
11244021023	EJERCICIO 2017 (OCT-DIC NVA ADMON)	0.00		1,031,279.71		1,031,279.71	0.00
11244021023001	APROVECHAMIENTOS DE TIPO CORRIENTE	0.00		1,031,279.71		1,031,279.71	0.00
11244022	FONDO DE APORTACIONES PARA LA INFRAESTRUCTURA SOCIAL MUNICIPAL	0.00		406,176.94		406,176.94	0.00
11244022026	EJERCICIO 2019	0.00		406,176.94		406,176.94	0.00

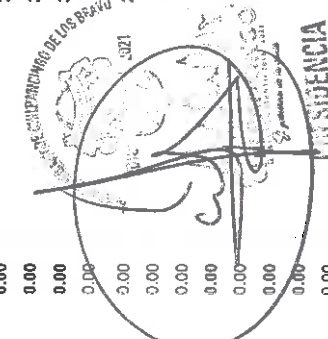

R. Ayuntamiento Items para Comprobación de Chilpancingo, Gro. A. Municipal CONTRALORIA INTERNA MUNICIPAL





H. AYUNTAMIENTO MUNICIPAL DE CHILPANCINGO, GRO.

SECRETARIA DE FINANZAS Y ADMINISTRACION

CONSOLIDADO



BALANZA DE COMPROBACIÓN DEL 1 DE ENERO AL 31 DE DICIEMBRE DEL 2019

C U E N T A	C O N C E P T O	SALDOS INICIALES		MOVIMIENTOS		SALDOS ACUMULADOS	
		AL 1 DE ENERO DE 2019		ENERO - DICIEMBRE 2019		AL 31 DE DICIEMBRE DE 2019	
		DEBE	HABER	DEBE	HABER	DEBE	HABER
11244022026001	APROVECHAMIENTOS DE TIPO CORRIENTE	0.00		406,176.94		406,176.94	0.00
11245	APROVECHAMIENTOS POR COBRAR	0.00		3,635,586.50		3,635,586.50	0.00
1125	DEUDORES POR ANTIPO DE LA TESORERIA A CORTO PLAZO	11,843,418.03		80,263,373.34		80,263,373.34	11,826,028.42
11251	DEUDORES POR FONDOS ROTATORIOS	11,843,418.03		80,263,373.34		80,263,373.34	11,826,028.42
11251021	GASTO CORRIENTE	9,004,352.95		8,159,268.65		10,381,635.71	6,781,985.89
11251021020	ADMON 2015 - 2018	13,310.91		0.00		0.00	13,310.91
11251021020014	JESUS FIGUEROA LUJANO	1,810.91		0.00		0.00	1,810.91
11251021020030	ARMANDO LUNA GABRIEL	4,000.00		0.00		0.00	4,000.00
11251021020033	ANTONIO HUITRON GOMEZ	7,500.00		0.00		0.00	7,500.00
11251021021	EJERCICIO 2016	95,086.00		0.00		0.00	95,086.00
11251021021026	ACEJANDRO ZEPEDA CASTORENA	11,600.00		0.00		0.00	11,600.00
11251021021033	2021 ANTONIO HUITRON GOMEZ	2,000.00		0.00		0.00	2,000.00
11251021021034	PATRICIA ACEVEDO PACHECO	10,083.00		0.00		0.00	10,083.00
11251021021038	CARLOTA GOMEZ RUEDA	553.00		0.00		0.00	553.00
11251021021065	FRANCISSCA SOLIS CARMONA	3,500.00		0.00		0.00	3,500.00
11251021021059	IRLANDO PASTOR SANTOS	34,150.00		0.00		0.00	34,150.00
11251021021063	FRANCISCO NUÑEZ ACEVEDO	8,000.00		0.00		0.00	8,000.00
11251021021078	JUMBERTO TEODORO CALVO REYNA	25,200.00		0.00		0.00	25,200.00
11251021022	EJERCICIO 2017	1,208,811.00		0.00		0.00	1,208,811.00
11251021022007	KARLO MISAELO LOPEZ DOMINGUEZ	288,800.00		0.00		0.00	288,800.00
11251021022009	RUFINA LEYVA MORALES	3,473.78		0.00		0.00	3,473.78
11251021022013	JULIO EFRAIN ZUNIGA CORTEZ	7,232.00		0.00		0.00	7,232.00
11251021022015	FABIOLA CAROLINA OLGUIN HIGUERA	0.01		0.00		0.00	0.01
11251021022017	ARTURO ROBLEDO MARTINEZ	12,028.64		0.00		0.00	12,028.64
11251021022018	ROBERTO RAMIREZ DIRCIO	100,500.00		0.00		0.00	100,500.00
11251021022020	ALEJANDRO ZEPEDA CASTORENA	15,000.00		0.00		0.00	15,000.00
11251021022023	JESUS FIGUEROA LUJANO	500.00		0.00		0.00	500.00
11251021022026	JUAN NAVA CABANAS	10,000.00		0.00		0.00	10,000.00
11251021022027	MANUEL DE JESUS BENITEZ FLORES	7,620.00		0.00		0.00	7,620.00
11251021022028	DOMINGO SALGADO MARTINEZ	20,000.00		0.00		0.00	20,000.00
11251021022033	ELIAS VILLALVA TEJEDA	15,000.00		0.00		0.00	15,000.00
11251021022034	PATRICIA ACEVEDO PACHECO	17,421.00		0.00		0.00	17,421.00

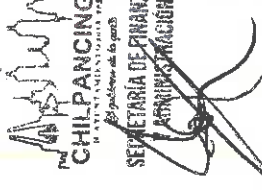

H. Ayuntamiento Municipal Chilpancingo, Gro. Controlador Municipal



H. AYUNTAMIENTO MUNICIPAL DE CHILPANCINGO, GRO.



SECRETARIA DE FINANZAS Y ADMINISTRACION

CONSOLIDADO

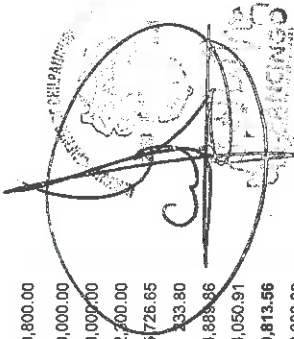

BALANZA DE COMPROBACION DEL 1 DE ENERO AL 31 DE DICIEMBRE DEL 2019

C U E N T A	C O N C E P T O	SALDOS INICIALES		MOVIMIENTOS		SALDOS ACUMULADOS	
		AL 1 DE ENERO DE 2019		ENERO - DICIEMBRE 2019		AL 31 DE DICIEMBRE DE 2019	
		DEBE	HABER	DEBE	HABER	DEBE	HABER
11251021022036	GUADALUPE LOPEZ CONTRERAS	49,356.64		0.00		49,356.64	
11251021022039	HUGO ARMANDO HERRERA DE LA O	139,400.00		0.00		139,400.00	
11251021022043	CARLOS ALBERTO OSORIO MORALES	12,141.31		0.00		12,141.31	
11251021022068	MARIO MORENO SOTELO	20,000.00		0.00		20,000.00	
11251021022073	JULIO CESAR MORALES DIAZ	10,000.00		0.00		10,000.00	
11251021022087	JUANITA AVILES RODRIGUEZ	17,600.00		0.00		17,600.00	
11251021022094	JOSE ENRIQUE PEREZ FRANCO	42,339.00		0.00		42,339.00	
11251021022095	ELIDETH ARAGON HERNANDEZ	12,397.40		0.00		12,397.40	
11251021022100	JOSE GUADALUPE PRIETO CARACHEO	80,800.00		0.00		80,800.00	
11251021022111	PEPITO JIMENEZ ALONSO	60,000.00		0.00		60,000.00	
11251021022112	NICOLAS JUAREZ HERNANDEZ	10,000.00		0.00		10,000.00	
11251021022114	ORLANDO PASTOR SANTOS	82,200.00		0.00		82,200.00	
11251021022120	MARIA TRINIDAD AGUIRRE LEON	15,726.65		0.00		15,726.65	
11251021022123	DANIEL MORALES PASTOR	233.80		0.00		233.80	
11251021022126	CALICIA SOLIS MORENO	94,889.86		0.00		94,889.86	
11251021022128	LUIS TREJO RODRIGUEZ	64,050.91		0.00		64,050.91	
11251021023	EJERCICIO 2017 (OCT-DIC)	260,813.56		0.00		260,813.56	
11251021023001	ARTURO ROBLEDO MARTINEZ	22,083.00		0.00		22,083.00	
11251021023004	ORLANDO PASTOR SANTOS	5,000.00		0.00		5,000.00	
11251021023006	JOSE LLUVIAS TENORIO	10,000.00		0.00		10,000.00	
11251021023007	DELIA CARBAJAL JIMENEZ	141,185.00		0.00		141,185.00	
11251021023014	LIBER ANTONIO HERNANDEZ MENDEZ	1,000.00		0.00		1,000.00	
11251021023020	MARIA DEL SOCORRO LOPEZ BELLO	545.56		0.00		545.56	
11251021023024	RUFINA LEYVA MORALES	6,000.00		0.00		6,000.00	
11251021023030	ARMANDO VILLALVA TEJADA	75,000.00		0.00		75,000.00	
11251021024	EJERCICIO 2018	7,040,957.82		0.00	2,000,000.00	5,040,957.82	
11251021024001	JESUS TEJEDA VARGAS	200,000.00		0.00		200,000.00	
11251021024004	ORLANDO PASTOR SANTOS	52,400.00		0.00		52,400.00	
11251021024009	MANUEL CAMPUZANO ROMERO	7,748.00		0.00		7,748.00	
11251021024011	JOEL EUGENIO FLORES	897.02		0.00		897.02	
11251021024014	LIBER ANTONIO HERNANDEZ MENDEZ	16,440.00		0.00		16,440.00	

H. AYUNTAMIENTO MUNICIPAL DE CHILPANCINGO, GRO.  
 SECRETARIA DE FINANZAS Y ADMINISTRACION  
 PRESIDENCIA



H. AYUNTAMIENTO MUNICIPAL DE CHILPANCINGO, GRO.

SECRETARIA DE FINANZAS Y ADMINISTRACION

CONSOLIDADO



BALANZA DE COMPROBACIÓN DEL 1 DE ENERO AL 31 DE DICIEMBRE DEL 2019

C U E N T A	C O N C E P T O	SALDOS INICIALES		M O V I M I E N T O S		SALDOS ACUMULADOS	
		AL 1 DE ENERO DE 2019		ENERO - DICIEMBRE 2019		AL 31 DE DICIEMBRE DE 2019	
		DEBE	HABER	DEBE	HABER	DEBE	HABER
11251021024020	MARIA DEL SOCORRO LOPEZ BELLO	30,576.62		0.00	0.00	30,576.62	
11251021024021	ELIAS VILLALVA TEJEDA	48,000.00		0.00	0.00	48,000.00	
11251021024026	RUFINA LEYVA MORALES	7,000.00		0.00	0.00	7,000.00	
11251021024031	ALICIA SOLIS MORENO	239,978.82		0.00	0.00	239,978.82	
11251021024036	ELOY GOMEZ ADAME	52,717.23		0.00	0.00	52,717.23	
11251021024038	FEDERICO SANTOS NAVA	42,307.42		0.00	0.00	42,307.42	
11251021024039	SARA PABLO GONZALEZ	2.48		0.00	0.00	2.48	
11251021024040	ANGEL ALMAZAN JUAREZ	14,640.00		0.00	0.00	14,640.00	
11251021024042	NATIVIDAD ADAME MARTINEZ	96,425.00		0.00	0.00	96,425.00	
11251021024048	GUADALUPE GUTIERREZ FLORES	10,020.00		0.00	0.00	10,020.00	
11251021024075	FRANCISCO DE LA CRUZ	2,695.00		0.00	0.00	2,695.00	
11251021024083	DOMINGO SALGADO MARTINEZ	25,000.00		0.00	0.00	25,000.00	
11251021024084	JOSE FRANCISCO HERNANDEZ RODRIGUEZ	7,500.00		0.00	0.00	7,500.00	
11251021024088	RAFAEL MENDOZA VENTURA	20,000.00		0.00	0.00	20,000.00	
11251021024089	CARLOS RAMIREZ GONZALEZ	40,000.00		0.00	0.00	40,000.00	
11251021024090	ALEJANDRO ARCE MALAGON	61,022.33		0.00	0.00	61,022.33	
11251021024091	SECRETARIA DE ENANZAS	1,000.00		0.00	0.00	1,000.00	
11251021024094	ANTONIO MEDRANO VAZQUEZ	3,000.00		0.00	0.00	3,000.00	
11251021024095	HELIDIZA MARGARITA LOPEZ CASTORENA	2,007,792.00		0.00	0.00	2,007,792.00	
11251021024097	JOSE ALBERTO LARA VARGAS	6,000.00		0.00	0.00	6,000.00	
11251021024099	CARLOS GATICA ENSALDO	24,000.00		0.00	0.00	24,000.00	
11251021024104	JULIO EFRAIN ZUNIGA CORTES	6,360.00		0.00	0.00	6,360.00	
11251021024102	ANGELICA MARIA JUAREZ FLORES	10,000.00		0.00	0.00	10,000.00	
11251021024103	CARLOS LEYVA VAZQUEZ	20,000.00		0.00	0.00	20,000.00	
11251021024105	MARCO ANTONIO LEYVA MENA	3,940,550.00		0.00	0.00	3,940,550.00	
11251021024107	LUIS TREJO RODRIGUEZ	8,000.00		0.00	0.00	8,000.00	
11251021024110	ARTURO ROBLEDO MARTINEZ	1,000.00		0.00	0.00	1,000.00	
11251021024112	JOSE VIDAL LAUREANO ORBE	10,000.00		0.00	0.00	10,000.00	
11251021024116	NICOLAS JUAREZ HERNANDEZ	6,085.90		0.00	0.00	6,085.90	
11251021024117	CARLOS ALBERTO LEYVA VAZQUEZ	3,800.00		0.00	0.00	3,800.00	
11251021024118	JUAN ALVARO MARTINEZ MILLAN	8,000.00		0.00	0.00	8,000.00	
11251021024119	FABIAN JESIEL YAÑEZ GARCIA			0.00	0.00		
Coram/ Balanza							

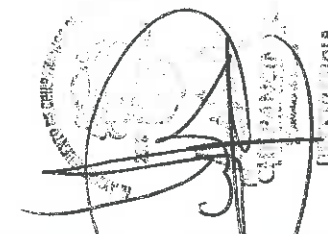

H. Ayuntamiento Municipal Constitucional de Chilpancingo, Gro. CONTRALORIA INTERNA MUNICIPAL



H. AYUNTAMIENTO MUNICIPAL DE CHILPANCINGO, GRO.

SECRETARIA DE FINANZAS Y ADMINISTRACION

CONSOLIDADO



BALANZA DE COMPROBACION DEL 1 DE ENERO AL 31 DE DICIEMBRE DEL 2019

C U E N T A	C O N C E P T O	SALDOS INICIALES		MOVIMIENTOS		SALDOS ACUMULADOS	
		AL 1 DE ENERO DE 2019		ENERO - DICIEMBRE 2019		AL 31 DE DICIEMBRE DE 2019	
		DEBE	HABER	DEBE	HABER	DEBE	HABER
11251021024119	MARIO ISAI PENA HIGUERA	10,000.00			0.00	0.00	10,000.00
11251021025	EJERCICIOS 2018 (NUEVA ADMON)	385,373.66		15,008.50		400,382.16	0.00
11251021025001	GASTOS A COMPROBAR	385,373.66		15,008.50		400,382.16	0.00
11251021025001003	GABRIEL MORLET MACIEL	2,080.93		0.00		2,080.93	0.00
11251021025001004	MARIA DE LOS ANGELES VAZQUEZ PASTOR	45,000.00		0.00		45,000.00	0.00
11251021025001009	FIDEL NAVA CRUZ	7,197.57		0.00		7,197.57	0.00
11251021025001011	LUIS CORTES ZARAGOZA	44,697.63		0.00		44,697.63	0.00
11251021025001012	TEODORA ALVAREZ FERNANDEZ	11,381.95		0.00		11,381.95	0.00
11251021025001015	CARLOTTA MCJICA MORGAN	9,196.87		0.00		9,196.87	0.00
11251021025001016	DIANA AIDA FLORES BELLO	8,076.83		10.00		8,086.83	0.00
11251021025001020	FRANCISCO JAVIER NIEVES RAMIREZ	25,000.00		0.00		25,000.00	0.00
11251021025001021	LAZARO ADALBERTO FIGUEROA RAMIREZ	19,983.00		0.00		19,983.00	0.00
11251021025001023	ERNESTO FRANCO PEREZ	0.00		0.00		0.00	0.00
11251021025001024	ESTHER GONZALEZ RIVERA	49.43		0.00		49.43	0.00
11251021025001027	ELVIRA LORANCA DOMINGUEZ	6,650.00		0.00		6,650.00	0.00
11251021025001029	JUAN CARLOS PATINO ARROYO	445.33		0.00		445.33	0.00
11251021025001031	ALICIA SOLIS MORENO	70,370.40		14,998.50		85,368.90	0.00
11251021025001033	MARIA RODRIGUEZ LOPEZ	8,000.00		0.00		8,000.00	0.00
11251021025001034	AUDELINA RAMIREZ SANCHEZ	3,600.00		0.00		3,600.00	0.00
11251021025001035	CLAUDIA ZELY OCAMPO LARA	50,000.00		0.00		50,000.00	0.00
11251021025001037	BRENDA JANET RAMIREZ SANTOS	20,240.00		0.00		20,240.00	0.00
11251021025001038	SEGURIDAD PUBLICA NOMINA	17,135.56		0.00		17,135.56	0.00
11251021025001040	DOMINGO SALGADO MARTINEZ	20,000.00		0.00		20,000.00	0.00
11251021025001042	AUDELINA RAMIREZ SANCHEZ	1,250.00		0.00		1,250.00	0.00
11251021025001044	MIGUEL ANGEL GUERRERO GARCIA	5,018.16		0.00		5,018.16	0.00
11251021026	EJERCICIOS 2019 (NUEVA ADMON)	0.00		8,144,260.15		7,981,253.55	163,006.60
11251021026001	GASTOS A COMPROBAR	0.00		8,144,260.15		7,981,253.55	163,006.60
11251021026001002	CELFA JUAREZ FIERRO	0.00		0.01		0.01	0.00
11251021026001003	EDGAR CAIN PEREZ BURCIAGA	0.00		40,000.00		40,000.00	0.00
11251021026001004	GURI CARMEN ZULUAGA HUERTA	0.00		76,000.00		76,000.00	0.00
11251021026001005	ELVIRA LORANCA DOMINGUEZ	0.00		3,185.00		3,185.00	0.00

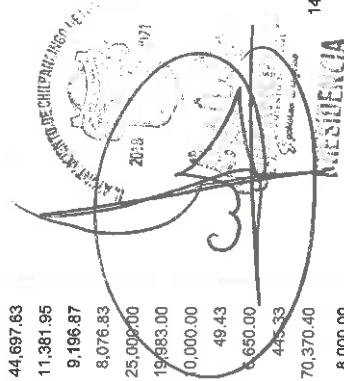

0.00 Ayuntamiento Municipal Constitucional de Chilpancingo, Gro. CONTROLORIA INTERNA MUNICIPAL





H. AYUNTAMIENTO MUNICIPAL DE CHILPANCINGO, GRO.

SECRETARIA DE FINANZAS Y ADMINISTRACION

CONSOLIDADO



BALANZA DE COMPROBACIÓN DEL 1 DE ENERO AL 31 DE DICIEMBRE DEL 2019

C U E N T A	C O N C E P T O	SALDOS INICIALES		M O V I M I E N T O S		SALDOS ACUMULADOS	
		AL 1 DE ENERO DE 2019		ENERO - DICIEMBRE 2019		AL 31 DE DICIEMBRE DE 2019	
		DEBE	HABER	DEBE	HABER	DEBE	HABER
11251021026001006	MARIA LUISA MENDEZ RIOS	0.00		59,000.00		59,000.00	0.00
11251021026001007	DIANA AIDA BELLO FLORES	0.00		61,238.84		61,238.84	0.00
11251021026001008	ANA LILIA LEYVA SOTELO	0.00		148,021.13		148,021.13	0.00
11251021026001009	OSCAR ARMANDO GARIBAY VALDEZ	0.00		166,023.13		166,023.13	0.00
11251021026001010	ADOLFO CALDERON NAVA	0.00		140,021.13		140,021.13	0.00
11251021026001011	SABINA RAMIREZ MENDOZA	0.00		148,021.13		148,021.13	0.00
11251021026001012	JESUS RAUL SALGADO CARACHURE	0.00		186,595.56		186,595.56	0.00
11251021026001013	IRENE BRENDA JANET RAMIREZ SANTOS	0.00		136,022.26		136,022.26	0.00
11251021026001015	VICTOR MANUEL ORTEGA CORONA	0.00		787,309.29		787,309.29	0.00
11251021026001016	MARIA DE LOURDES ORTIZ BASURTO	0.00		15,500.00		15,500.00	0.00
11251021026001017	ANTONIO OROZCO GUADARRAMA	0.00		310,831.00		310,831.00	0.00
11251021026001018	GABRIEL MORLET MACIEL	0.00		406,104.96		406,104.96	0.00
11251021026001019	ELADIO AGUILAR CASTREJON	0.00		25,000.00		25,000.00	0.00
11251021026001020	GUSTAVO CERVANTES CHAVELA	0.00		15,000.00		15,000.00	0.00
11251021026001021	AUDELINA RAMIREZ CHAVEZ	0.00		57,970.00		57,970.00	0.00
11251021026001022	JAVIER VERGARA MARTINEZ	0.00		114,800.00		114,800.00	0.00
11251021026001023	JULIS CORTES ZARAGOZA	0.00		94,850.00		94,850.00	0.00
11251021026001024	MARIA DE LOS ANGELES VAZQUEZ PASTOR	0.00		120,000.00		120,000.00	0.00
11251021026001025	ADRIANA JOSAHANDY H.LUZ TELLEZ	0.00		42,862.20		42,862.20	0.00
11251021026001026	SAUL CASTRO HERNANDEZ	0.00		1,500.00		1,500.00	0.00
11251021026001028	ABRAHAM JIMENEZ MONTIEL	0.00		275,528.00		275,528.00	0.00
11251021026001029	FIDEL NAVA CRUZ	0.00		707,404.00		707,404.00	153,500.00
11251021026001030	ROCIO VEGA BAUTISTA	0.00		511,037.75		511,037.75	0.00
11251021026001031	FERNANDO CALIXTO CUEVAS	0.00		87,400.00		87,400.00	0.00
11251021026001032	BULMARO TAPIA SOBERANIS	0.00		113,515.99		113,515.99	0.00
11251021026001033	GUADALUPE ALMAZAN MORALES	0.00		154,079.13		154,079.13	0.00
11251021026001034	MANUEL VARGAS BARRIENTOS	0.00		154,079.13		154,079.13	0.00

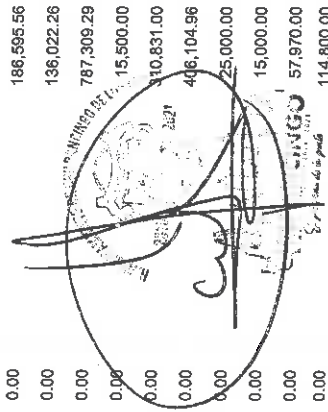
  
 SECRETARIA DE FINANZAS Y ADMINISTRACION

  
 CHILPANCINGO



Ayuntamiento Municipal Constitucional de  
 CONTRALORIA INTERNA MUNICIPAL



H. AYUNTAMIENTO MUNICIPAL DE CHILPANCINGO, GRO.

SECRETARIA DE FINANZAS Y ADMINISTRACION

CONSOLIDADO



BALANZA DE COMPROBACIÓN DEL 1 DE ENERO AL 31 DE DICIEMBRE DEL 2019

C U E N T A	C O N C E P T O	SALDOS INICIALES		M O V I M I E N T O S		SALDOS ACUMULADOS	
		AL 1 DE ENERO DE 2019		ENERO - DICIEMBRE 2019		AL 31 DE DICIEMBRE DE 2019	
		DEBE	HABER	DEBE	HABER	DEBE	HABER
11251021026001035	LINO CASTILLO CANDIA	0.00		137,080.00		137,080.00	0.00
11251021026001036	ITANDUVI VILLALBA NAJERA	0.00		154,079.13		154,079.13	0.00
11251021026001037	DELIA CARBAJAL JIMENEZ	0.00		150,894.00		150,894.00	0.00
11251021026001038	VIANEY CASTORENA TENORIO	0.00		711,548.89		711,548.89	0.00
11251021026001039	MIGUEL ANGEL GUERRERO GARCIA	0.00		4,000.00		4,000.00	0.00
11251021026001040	DANIEL MILLAN GARCIA	0.00		10,000.00		10,000.00	0.00
11251021026001041	GILBERTO BAHENA DIAZ	0.00		82,088.00		82,088.00	0.00
11251021026001042	WILIBALDO VALENTE PASTOR	0.00		12,700.00		12,700.00	0.00
11251021026001044	SAMIR DANIEL AVILA BONILLA	0.00		157,080.26		157,080.26	0.00
11251021026001045	BLANCA ALICIA CAMACHO DE LA CRUZ	0.00		123,021.13		123,021.13	0.00
11251021026001046	HECECILIA ZUÑIGA EULOGIO	0.00		3,200.00		3,200.00	0.00
11251021026001047	CARLOTA MCJICA MORGAN	0.00		131,707.00		131,707.00	0.00
11251021026001048	ALICIA SOLIS MORENO	0.00		544,669.43		544,669.43	0.00
11251021026001049	JUDITH IBETH POLITO CATALAN	0.00		7,000.00		7,000.00	0.00
11251021026001050	HUMBERTO HERRERA ALTAMIRANO	0.00		12,293.00		12,293.00	0.00
11251021026001051	RUFINA IGNACIO DIAZ	0.00		10,000.00		10,000.00	0.00
11251021026001054	MARBELLA OLIVEROS MUÑOZ	0.00		1,700.00		1,700.00	0.00
11251021026001055	JESUS PERALTA MOISENT	0.00		21,484.00		21,484.00	0.00
11251021026001056	GUILLERMO HERNANDEZ BELTRAN	0.00		600.00		600.00	0.00
11251021026001057	HIGLABI GARCIA RAMOS	0.00		35,000.00		35,000.00	0.00
11251021026001058	PABLO ALCALA RODRIGUEZ	0.00		20,000.00		20,000.00	0.00
11251021026001059	LAURA PATRICIA BARRAGAN DE LA CRUZ	0.00		10,000.00		10,000.00	0.00
11251021026001060	JOSE ALBERTO SANTOS GARCIA	0.00		3,550.00		3,550.00	0.00
11251021026001061	FRANCISCO JAVIER RIOS MARTINEZ	0.00		5,000.00		5,000.00	0.00
11251021026001062	DIANA GARCIA MOLINA	0.00		43,002.72		43,002.72	0.00
11251021026001063	FRANCISCO JAVIER NIEVES RAMIREZ	0.00		56,700.00		56,700.00	0.00
11251021026001064	ALBA NELI NAVARRETE LORENZO	0.00		3,000.00		3,000.00	0.00
11251021026001065	MICHELLE SALVADOR CLARA	0.00		1,000.00		1,000.00	0.00
11251021026001066	ANIBAL PEÑA GUTIERREZ	0.00		72,000.00		72,000.00	0.00
11251021026001067	ENRIQUE BARANDA ATRISCO	0.00		42,719.33		42,719.33	0.00

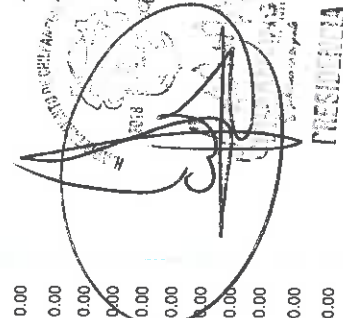

M. Ayuntamiento Municipal Funcionario de Chilpancingo, Gro. CONTRALORIA INTERNA MUNICIPAL



H. AYUNTAMIENTO MUNICIPAL DE CHILPANCINGO, GRO.

SECRETARIA DE FINANZAS Y ADMINISTRACION

CONSOLIDADO



BALANZA DE COMPROBACION DEL 1 DE ENERO AL 31 DE DICIEMBRE DEL 2019

C U E N T A	C O N C E P T O	SALDOS INICIALES		M O V I M I E N T O S		SALDOS ACUMULADOS	
		AL 1 DE ENERO DE 2019		ENERO - DICIEMBRE 2019		AL 31 DE DICIEMBRE DE 2019	
		DEBE	HABER	DEBE	HABER	DEBE	HABER
11251021026001069	MARIO JIMENEZ MARTINEZ	0.00		21,139.32		21,139.32	0.00
11251021026001070	JESUS VAZQUEZ RIVERA	0.00		19,268.30		19,268.30	0.00
11251021026001072	MARTHA IMELDA CUENCA VELEZ	0.00		88,520.00		88,520.00	0.00
11251021026001073	YURIDIANA FLORES MARES	0.00		5,000.00		5,000.00	0.00
11251021026001074	LORENA SANTOS HERNANDEZ	0.00		3,000.00		3,000.00	0.00
11251021026001076	MAURO SERENO TAPIA	0.00		5,640.00		5,640.00	0.00
11251021026001077	FABRICIO BAUTISTA ROMERO	0.00		6,000.00		6,000.00	0.00
11251021026001078	MARISOL CUEVAS SERRANO	0.00		1,000.00		1,000.00	0.00
11251021026001079	SERAIDA SALGADO BANDERA	0.00		81,856.00		81,856.00	264.60
11251021026001080	ANANIA TERESA RAMIREZ SOLIS	0.00		50,000.00		50,000.00	0.00
11251021026001081	CARLOS AGUSTIN POLITO PASTOR	0.00		22,520.00		22,520.00	9,242.00
11251021026001082	ANA LAURA MEDINA BELLO	0.00		31,500.00		31,500.00	0.00
11251021026001084	JAIR GERARDO GERVACIO VALENTIN	0.00		28,000.00		28,000.00	0.00
11251021026001085	FREYD JESUS CASTRO SANCHEZ	0.00		8,000.00		8,000.00	0.00
11251021026001086	FERNANDO CAMERO MARTINEZ	0.00		46,800.00		46,800.00	0.00
11251022	FONDO DE APORT P/INFRA SOC MPAL ( F.A.I.S.M. )	3.00		3,791.95		3.00	3,791.95
11251022025	EJERCICIO 2018 NUEVA ADMINISTRACION	3.00		0.00		3.00	0.00
11251022025001	MA. DEL ROCIO VEGA BAUTISTA	3.00		0.00		3.00	0.00
11251022026	EJERCICIO 2019	0.00		3,791.95		0.00	3,791.95
11251022026001	BULMARO TAPIA SOBERANIS	0.00		3,791.95		0.00	3,791.95
11251023	FONDO DE APORT P/IFORT DE LOS MPIO S	2,814,761.17		258,709.56		2,996,911.58	2,776,559.15
11251023021	ADMION 2016	11,769.00		0.00		11,769.00	0.00
11251023021001	ESTEBAN ESPINOSA MONTOYA	5,901.00		0.00		5,901.00	0.00
11251023021007	JAIME EUMIR VELA GUEVARA	5,868.00		0.00		5,868.00	0.00
11251023022	ADMION 2017	111,035.67		0.00		111,035.67	0.00
11251023022001	ESTEBAN ESPINOSA MONTOYA	11,009.43		0.00		11,009.43	0.00
11251023022003	LUIS DANIEL BAUTISTA GONZALEZ	9,859.92		0.00		9,859.92	0.00
11251023022004	HUMBERTO ALARCON ALARCON	856.19		0.00		856.19	0.00
11251023022006	ALICIA SOLIS MORENO	30,045.26		0.00		30,045.26	0.00
11251023022007	VICTOR HUGO NAVA LOPEZ	11,841.87		0.00		11,841.87	0.00

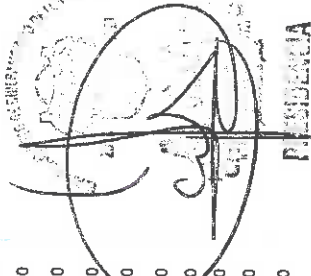

Ayuntamiento Municipal Constitucional de CHILPANCINGO, TULANA, MUNICIPAL



H. AYUNTAMIENTO MUNICIPAL DE CHILPANCINGO, GRO.

SECRETARIA DE FINANZAS Y ADMINISTRACION

CONSOLIDADO



BALANZA DE COMPROBACIÓN DEL 1 DE ENERO AL 31 DE DICIEMBRE DEL 2019

C U E N T A	C O N C E P T O	SALDOS INICIALES		M O V I M I E N T O S		SALDOS ACUMULADOS	
		AL 1 DE ENERO DE 2019		ENERO - DICIEMBRE 2019		AL 31 DE DICIEMBRE DE 2019	
		DEBE	HABER	DEBE	HABER	DEBE	HABER
11251023022008	JAIMÉ EUMIR VELA GUEVARA	2,400.00			0.00	0.00	2,400.00
11251023022009	EDUARDO SALINAS MENESES	16,000.00			0.00	0.00	16,000.00
11251023022010	DANTE JAVIER MOLINA MONTES DE OCA	8,136.00			0.00	0.00	8,136.00
11251023022011	CLAUDIA FERNANDEZ BOLAÑOS	1,650.00			0.00	0.00	1,650.00
11251023022012	JUAN CARLOS CASTRO NAVA	1,737.00			0.00	0.00	1,737.00
11251023022013	VICTOR MANUEL OSORIO GUEVARA	5,800.00			0.00	0.00	5,800.00
11251023022014	ARELY LUNA BIBIANO	5,800.00			0.00	0.00	5,800.00
11251023022015	TANIA YAZMIN GONZALEZ NAVA	5,800.00			0.00	0.00	5,800.00
11251023023	EJERCICIO 2017 (OCT-DIC)	1,208,943.83		6.00	0.00	0.00	1,208,943.83
11251023023001	ROBERTO RESENDIZ DIAZ	5,000.00			0.00	0.00	5,000.00
11251023023004	ESTEBAN ESPINOSA MONTOYA	13,833.75			0.00	0.00	13,833.75
11251023023008	ALICIA SOLIS MORENO	1,190,110.08			0.00	0.00	1,190,110.08
11251023024	EJERCICIO 2018	1,444,810.65		6.00	0.00	0.00	1,444,810.65
11251023024001	JORGE PEDRO ARMENTA SALGADO	3,600.00			0.00	0.00	3,600.00
11251023024002	FILIMON PINEDA AQUINO	10,000.00			0.00	0.00	10,000.00
11251023024003	MIGUEL ANGEL HERNANDEZ GOMEZ	35,000.00			0.00	0.00	35,000.00
11251023024005	HUMBERTO ALARCON ALARCON	10,000.00			0.00	0.00	10,000.00
11251023024006	JOEL EUGENIO FLORES	10,000.00			0.00	0.00	10,000.00
11251023024009	CRISTHIAN ALBERTO ADAME MEMIJE	50,000.00			0.00	0.00	50,000.00
11251023024011	PAULINO MOLINA LOPEZ	80,000.00			0.00	0.00	80,000.00
11251023024013	ALEJANDRO ARCE MALAGON	60,000.00			0.00	0.00	60,000.00
11251023024014	LAZARO ADALBERTO FIGUEROA RAMIREZ	11,160.65			0.00	0.00	11,160.65
11251023024015	GUSTAVO VELA GUEVARA	3,500.00			0.00	0.00	3,500.00
11251023024017	JULIO EFRAIN ZUÑIGA CORTES	7,000.00			0.00	0.00	7,000.00
11251023024018	EDNA ELIC MANRIQUE NAJERA	32,000.00			0.00	0.00	32,000.00
11251023024019	LUIS TREJO RODRIGUEZ	3,600.00			0.00	0.00	3,600.00
11251023025	EJERCICIO 2018 NUEVA ADMINISTRACION	1,138,950.00		2,457.40	0.00	0.00	1,138,950.00
11251023025002	LAZARO ADALBERTO FIGUEROA	38,202.02			0.00	0.00	38,202.02
11251023025004	HUMBERTO ALARCON ALARCON	4,877.00			0.00	0.00	4,877.00
11251023025005	JORGE PEDRO ARMENTA SALGADO	5,025.01			0.00	0.00	5,025.01
11251023025007	EDGAR CAIN PÉREZ BURCIAGA	12,000.00			0.00	0.00	12,000.00
11251023025010	ALICIA SOLIS MORENO	3,758.91			0.00	0.00	3,758.91
11251023028	EJERCICIO 2019	12,541.10		2,457.40	0.00	0.00	14,998.50
Coram/ Balanza		0.00		256,252.16	256,252.16	0.00	256,252.16

*[Handwritten signature]*  
 SECRETARIA DE FINANZAS Y ADMINISTRACION  
 CHILPANCINGO  
 PRESIDENCIA



H. Ayuntamiento Municipal Chilpancingo  
 Contraloría Municipal  
 2,457.40  
 256,252.16





H. AYUNTAMIENTO MUNICIPAL DE CHILPANCINGO, GRO.

SECRETARIA DE FINANZAS Y ADMINISTRACION

CONSOLIDADO



BALANZA DE COMPROBACION DEL 1 DE ENERO AL 31 DE DICIEMBRE DEL 2019

C U E N T A	C O N C E P T O	SALDOS INICIALES		M O V I M I E N T O S		SALDOS ACUMULADOS	
		AL 1 DE ENERO DE 2019		ENERO - DICIEMBRE 2019		AL 31 DE DICIEMBRE DE 2019	
		DEBE	HABER	DEBE	HABER	DEBE	HABER
11251023026002	EDGAR CAIN PEREZ BURCIAGA	0.00		34,085.00		34,085.00	0.00
11251023026003	SAMIR DANIEL AVILA BONILLA	0.00		8,002.26		8,002.26	0.00
11251023026004	VICTOR MANUEL ORTEGA CORONA	0.00		63,944.89		63,944.89	0.00
11251023026005	ALICIA SOLIS MORENO	0.00		64,000.00		64,000.00	0.00
11251023026006	GUSTAVO CERVANTES CHAVELA	0.00		5,000.00		5,000.00	0.00
11251023026007	ROCIO VEGA BAUTISTA	0.00		170.01		170.01	0.00
11251023026008	FABRICIO BAUTISTA ROMERO	0.00		42,000.00		42,000.00	0.00
11251023026009	LAZARO ADALBERTO FIGUEROA RAMIREZ	0.00		39,050.00		39,050.00	0.00
11251025	PORTASEG FEDERAL	24,300.91		182,856.96		207,157.87	0.00
11251025024	EJERCICIO 2018	24,300.91		0.00		24,300.91	0.00
11251025024002	JEJIO EFRAIN ZUÑIGA CORTES	24,300.91		0.00		24,300.91	0.00
11251025026	EJERCICIO 2019	0.00		182,856.96		182,856.96	0.00
11251025026001	GUSTAVO CERVANTES CHAVELA	0.00		41,600.00		41,600.00	0.00
11251025026002	RUTH SARAI NAVARRO CANO	0.00		50,506.96		50,506.96	0.00
11251025026003	JULIA PABLO AHUEJOTE	0.00		23,500.00		23,500.00	0.00
11251025026004	NAYELI MINERVA MORENO GALEANA	0.00		23,500.00		23,500.00	0.00
11251025026005	JUAN MOISES OROPEZA	0.00		23,500.00		23,500.00	0.00
11251025026006	LIZZETH ALMAZAN ROSAS	0.00		20,250.00		20,250.00	0.00
11251032	PROGRAMA PRODDER-CONAGUA	0.00		5,387.93		5,387.93	0.00
11251032026	EJERCICIO 2019	0.00		5,387.93		5,387.93	0.00
11251032026001	MA. DEL ROCIO VEGA BAUTISTA	0.00		5,387.93		5,387.93	0.00
11251041	INGRESOS PROPIOS	0.00		5,387.93		5,387.93	0.00
11251041026	EJERCICIOS 2019	0.00		69,419,355.70		69,419,355.70	2,234,002.59
11251041026001	GASTOS A COMPROBAR	0.00		71,653,358.29		71,653,358.29	2,234,002.59
11251041026001001	CELFA JUAREZ FIERRO	0.00		71,653,358.29		71,653,358.29	2,234,002.59
11251041026001002	DEPOSITOS PUNTO DE VENTA	0.00		66,211,020.10		66,211,020.10	2,021,525.35
113	DERECHOS A RECIBIR BIENES O SERVICIOS	0.00		5,442,338.19		5,442,338.19	212,477.24
1131	ANTICIPO A PROVEEDORES POR ADQUISICIÓN DE BIENES Y PRESTACION DE SERVICIOS A CORTO PLAZO	10,842,325.87		67,855,106.06		78,697,431.93	9,130,100.21
11311	ANTICIPO A PROVEEDORES POR ADQUISICIÓN DE BIENES Y PRESTACION DE SERVICIOS A CORTO PLAZO	10,842,325.87		67,855,106.06		78,697,431.93	9,130,100.21
Coram/ Balanza		10,842,325.87		67,855,106.06		78,697,431.93	9,130,100.21

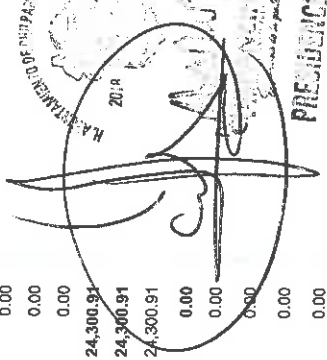
  
 H. AYUNTAMIENTO MUNICIPAL DE CHILPANCINGO, GRO.  
 SECRETARIA DE FINANZAS Y ADMINISTRACION  
 2019



H. Ayuntamiento Municipal Constitucional de Chilpancingo, Gro.  
 CONTRALORIA INTERNA MUNICIPAL



H. AYUNTAMIENTO MUNICIPAL DE CHILPANCINGO, GRO.

SECRETARIA DE FINANZAS Y ADMINISTRACION

CONSOLIDADO



BALANZA DE COMPROBACIÓN DEL 1 DE ENERO AL 31 DE DICIEMBRE DEL 2019

C U E N T A	C O N C E P T O	SALDOS INICIALES		MOVIMIENTOS		SALDOS ACUMULADOS	
		AL 1 DE ENERO DE 2019		ENERO - DICIEMBRE 2019		AL 31 DE DICIEMBRE DE 2019	
		DEBE	HABER	DEBE	HABER	DEBE	HABER
11311021	GASTO CORRIENTE	4,883,295.89		4,276,419.44	3,608,961.27	5,550,754.06	
11311021020	ADMON 2015-2018	44,000.00		0.00	0.00	44,000.00	
1131102102004	MARIA DEL ROCIO RUIZ GUTIERREZ	44,000.00		0.00	0.00	44,000.00	
11311021021	EJERCICIO 2016	407,646.53		0.00	0.00	407,646.53	
11311021021012	JESUS SALAZAR IBARRA	69,600.00		0.00	0.00	69,600.00	
11311021021014	AGENCIA DE VIAJES ACUARIO SA DE CV	25,692.00		0.00	0.00	25,692.00	
11311021021016	ASFOR S.A. DE C.V.	249,200.00		0.00	0.00	249,200.00	
11311021021017	MARIO LOYA JUAREZ	27,505.65		0.00	0.00	27,505.65	
11311021021019	GUSTAVO SALAZAR ADAME	10,000.00		0.00	0.00	10,000.00	
11311021021023	GRUPO RADIODIFUSORAS CAPITAL S.A. DE C.V.	20,000.00		0.00	0.00	20,000.00	
11311021021027	INVESTOR ORTEGA ALMEIDA MORALES	5,200.00		0.00	0.00	5,200.00	
11311021021028	TELEFONOS DE MEXICO, S.A.B. DE C.V.	248.88		0.00	0.00	248.88	
11311021021030	MULTIMEDIOS DE GUERRERO S.A. DE C.V.	200.00		0.00	0.00	200.00	
11311021022	EJERCICIO 2017	3,857,997.14		0.00	0.00	3,857,997.14	
11311021022001	VICTOR MALDONADO GOMEZ	310,280.00		0.00	0.00	310,280.00	
11311021022002	DETROIT DIESEL ALLISON DE MEXICO S DE R.L. DE C.V.	1,682,000.00		0.00	0.00	1,682,000.00	
11311021022006	MARTIN DE DIOS AYALA	150,000.00		0.00	0.00	150,000.00	
11311021022009	JOSE GUADALUPE FUENTES BRITO	484.99		0.00	0.00	484.99	
11311021022018	JOEL SALGADO ADAME	200,000.00		0.00	0.00	200,000.00	
11311021022019	HORTENCIA NAVARRETE MORAN	100,000.00		0.00	0.00	100,000.00	
11311021022020	MANUEL CASTILLO JAIMES	44,000.00		0.00	0.00	44,000.00	
11311021022021	LIXO PROYECTOS AMBIENTALES, S.A.A DE C.V.	1,250,000.00		0.00	0.00	1,250,000.00	
11311021022023	ARELI MARTINEZ GARCIA	42,925.15		0.00	0.00	42,925.15	
11311021022024	FELIPE DIAZ MELCHOR	15,000.00		0.00	0.00	15,000.00	
11311021022025	JOSE ANTONIO NAMBO ABARCA	13,307.00		0.00	0.00	13,307.00	
11311021022026	ROSALBA HERNANDEZ JUAREZ	50,000.00		0.00	0.00	50,000.00	
11311021024	EJERCICIO 2018	573,652.22		300,000.00	0.00	873,652.22	
11311021024002	GRUPO GASC GUERRERO S.A. DE C.V.	5,212.22		0.00	0.00	5,212.22	
11311021024005	BERNARDO LOPEZ CORONA	500,000.00		300,000.00	0.00	800,000.00	
11311021024008	LUIS ROBERTO HERNANDEZ SOTELO	33,640.00		0.00	0.00	33,640.00	
11311021024010	KEVIN MANUEL BELTRAN HERNANDEZ	34,800.00		0.00	0.00	34,800.00	
11311021025	EJERCICIO 2019	0.00		3,976,419.44	3,608,961.27	367,458.17	

SECRETARIA DE FINANZAS Y ADMINISTRACION  
 2019  
 2019



M. Ayuntamiento Municipal Constitucional de Chilpancingo  
 CONTRALORIA INTERNA MUNICIPAL

*[Handwritten signature]*



H. AYUNTAMIENTO MUNICIPAL DE CHILPANCINGO, GRO.

SECRETARIA DE FINANZAS Y ADMINISTRACION

CONSOLIDADO



BALANZA DE COMPROBACIÓN DEL 1 DE ENERO AL 31 DE DICIEMBRE DEL 2019

C U E N T A	C O N C E P T O	SALDOS INICIALES		MOVIMIENTOS		SALDOS ACUMULADOS	
		AL 1 DE ENERO DE 2019		ENERO - DICIEMBRE 2019		AL 31 DE DICIEMBRE DE 2019	
		DEBE	HABER	DEBE	HABER	DEBE	HABER
11311021026001	EFREN BRAVO PERALTA	0.00		251,720.00		251,720.00	0.00
11311021026003	COMERCIALIZADORA GENERAL DE LA MONTAÑA S.A. DE C.V.	0.00		200,000.00		200,000.00	0.00
11311021026004	JULIO CESAR CABRERA RAMIREZ	0.00		100,000.00		100,000.00	0.00
11311021026005	MODERNIZACION EN PROYECTOS INTEGRALES DE CONSTRUCCION SA DE CV	0.00		40,000.00		40,000.00	0.00
11311021026006	LUIS DANIEL OLMEDO TENORIO	0.00		7,000.00		7,000.00	0.00
11311021026008	SECRETARIA DE FINANZAS Y ADMINISTRACION DEL GOBIERNO DEL ESTADO DE GUERRERO	0.00		1,660,386.00		1,660,386.00	0.00
11311021026009	CARMEN DENISSE GARCIA GAMA	0.00		700,000.00		700,000.00	0.00
11311021026010	EFRAIN RAMOS RAMIREZ	0.00		20,880.00		20,880.00	0.00
11311021026013	MA. DE LA SOLEDAD LUNA ALARCON	0.00		4,800.00		4,800.00	0.00
11311021026014	INJUMOS HOSPITALARIOS DINAMICOS, S.A. DE C. V.	0.00		300,000.00		300,000.00	0.00
11311021026015	202 INJUMOS HOSPITALARIOS DINAMICOS, S.A. DE C. V.	0.00		6,525.00		6,525.00	0.00
11311021026016	MARY LAURY GALLARDO ARREOLA	0.00		200.00		200.00	0.00
11311021026017	EMILIO IGNACIO ORTIZ URIBE	0.00		10,000.00		10,000.00	0.00
11311021026018	YURIRIA YANET BAHENA ALVAREZ	0.00		10,989.96		10,989.96	0.00
11311021026020	EDUARDO HERNANDEZ SOTO	0.00		2,430.00		2,430.00	0.00
11311021026021	COMISION FEDERAL DE ELECTRICIDAD	0.00		1,327.00		1,327.00	0.00
11311021026022	HECTOR GARCIA ALVAREZ	0.00		8,000.00		8,000.00	0.00
11311021026023	VICTOR JORDAN ALVAREZ	0.00		135,000.00		135,000.00	0.00
11311021026024	ANTONIO ANTAÑO MORENO	0.00		100,000.00		100,000.00	0.00
11311021026025	SERVICIOS PATRIMONIALES JVM SA DE CV	0.00		31,927.76		31,927.76	0.00
11311021026026	EDGARDO ASTUDILLO MORALES	0.00		74,770.32		74,770.32	0.00
11311021026027	ANDRES CONTRERAS HERNANDEZ	0.00		20,000.00		20,000.00	0.00
11311021026028	MARICELA GUTIERREZ CHULA	0.00		695.00		695.00	0.00
11311021026029	FAUSTO BICTORINO SUÑIGA	0.00		4,910.40		4,910.40	0.00
11311021026030	FEDERICO GONZALEZ CUENCA	0.00		105.00		105.00	0.00
11311021026031	TODOS DECORACIONES NAVIDENAS Y PATRIAS S. A. DE C.V.	0.00		250,908.00		250,908.00	0.00
11311021026032	HOSPITAL SUR CORPORATIVO S.A. DE C.V.	0.00		33,845.00		33,845.00	0.00
11311022	FONDO DE APORT PINFRA SOC MPAL	2,914,357.99		54,734,921.16		56,454,604.99	1,194,674.16
11311022021	EJERCICIO 2016	1,010,546.41		0.00		0.00	1,010,546.41
11311022021012	JACINTO JAVIER CASTILLO SARRION	1,010,546.41		0.00		0.00	1,010,546.41

SECRETARIA DE FINANZAS Y ADMINISTRACION  
 CHILPANCINGO  
 2019



H. Ayuntamiento Municipal Constitucional de Chilpancingo, Guerrero  
 CONTRAFOFOTOGRAFIA



H. AYUNTAMIENTO MUNICIPAL DE CHILPANCINGO, GRO.

SECRETARIA DE FINANZAS Y ADMINISTRACION

CONSOLIDADO



BALANZA DE COMPROBACIÓN DEL 1 DE ENERO AL 31 DE DICIEMBRE DEL 2019

C U E N T A	C O N C E P T O	SALDOS INICIALES		MOVIMIENTOS		SALDOS ACUMULADOS	
		AL 1 DE ENERO DE 2019		ENERO - DICIEMBRE 2019		AL 31 DE DICIEMBRE DE 2019	
		DEBE	HABER	DEBE	HABER	DEBE	HABER
11311022022	EJERCICIO 2317						
11311022022003	PROMAT FLOLAG SA DE CV	1,029,771.58		0.00	1,029,771.58	0.00	0.00
11311022024	EJERCICIO 2318						
11311022024007	CORPORATIVO DE DESARROLLO CONSTRUCTOR SA DE CV	874,040.00		0.00	874,040.00	0.00	0.00
11311022024016	LORENZO SANCHEZ REYNA	200,000.00		0.00	200,000.00	0.00	0.00
11311022024018	CORPORACION DE SERVICIOS INTEGRALES ACA FUTURE SA DE CV	300,000.00		0.00	300,000.00	0.00	0.00
11311022026	EJERCICIO 2319						
11311022026001	COMISION DE AGUA POTABLE ALCANTARILLADO Y SANEAMIENTO DEL ESTADO DE GUERRERO	0.00		54,734,921.16	54,734,921.16	184,127.75	0.00
11311022026002	DISTRIBUIDORA SEICOM SA DE CV	0.00		36,996,828.58	36,996,828.58	0.00	0.00
11311022026006	OFER CONSTRUCCIONES SA DE CV	0.00		426,567.88	426,567.88	0.00	0.00
11311022026004	COMISION DE INFRAESTRUCTURA CARRETERA Y AEROPORTUARIA DEL ESTADO DE GUERRERO	0.00		812,023.38	812,023.38	0.00	0.00
11311022026005	VACOMEZ SA DE CV	0.00		15,639,127.75	15,639,127.75	184,127.75	0.00
11311023021	EJERCICIO 2015-2018						
11311023021006	EJERCICIO 2016	730,892.47		7,510,965.46	7,510,965.46	730,892.47	0.00
11311023021007	JAVIER MUÑOZ GUTIERREZ	462,000.00		0.00	0.00	462,000.00	0.00
11311023021008	CONSTRUCTORA MORAYMA, S.A DE C.V	180,000.00		0.00	0.00	180,000.00	0.00
11311023022	EJERCICIO 2017						
11311023022003	JORGE LEON SAENZ	288,560.00		0.00	0.00	288,560.00	0.00
11311023022004	NATSA MACHINERY S.A. DE C.V.	12,412.00		0.00	0.00	12,412.00	0.00
11311023022005	MARIA ISABEL SANTACRUZ RAMIREZ	250,000.00		0.00	0.00	250,000.00	0.00
11311023024	EJERCICIO 2017						
11311023024001	GRUPO GASO GUERRERO SA DE CV	6,148.00		0.00	0.00	6,148.00	0.00
11311023026	EJERCICIO 2019						
11311023026001	SEGUROS ARGOS S.A DE C.V	332.47		0.00	0.00	332.47	0.00
11311023026002	CARLOS ALBERTO SUCK BELLO	332.47		0.00	0.00	332.47	0.00
11311023026003	ARGELIA DORALI NAVA VIGURI	0.00		7,510,965.46	7,510,965.46	0.00	0.00
11311023026006	FELIX LITO AMBROSIO	0.00		1,005,965.46	1,005,965.46	0.00	0.00
11311025	FORTASEG	0.00		5,000.00	5,000.00	0.00	0.00
11311025026	EJERCICIO 2019						
11311025026001	SECRETARIA DE FINANZAS Y ADMINISTRACION DEL ESTADO DE GUERRERO	0.00		2,000,000.00	2,000,000.00	0.00	0.00
11311025026002		0.00		4,500,000.00	4,500,000.00	0.00	0.00
11311025026003		0.00		1,332,800.00	1,332,800.00	0.00	0.00
11311025026004		0.00		1,332,800.00	1,332,800.00	0.00	0.00
11311025026005		0.00		1,332,800.00	1,332,800.00	0.00	0.00
11311025026006		0.00		1,332,800.00	1,332,800.00	0.00	0.00

SECRETARIA DE FINANZAS Y ADMINISTRACION



Ayuntamiento de Chilpancingo, Gro.  
 CONTRALORIA MUNICIPAL

mércoles 25 marzo 2020

6.08.08 PM

Coram/ Balanza









H. AYUNTAMIENTO MUNICIPAL DE CHILPANCINGO, GRO.

SECRETARIA DE FINANZAS Y ADMINISTRACION

CONSOLIDADO



BALANZA DE COMPROBACION DEL 1 DE ENERO AL 31 DE DICIEMBRE DEL 2019

C U E N T A	C O N C E P T O	SALDOS INICIALES		M O V I M I E N T O S		SALDOS ACUMULADOS	
		AL 1 DE ENERO DE 2019		ENERO - DICIEMBRE 2019		AL 31 DE DICIEMBRE DE 2019	
		DEBE	HABER	DEBE	HABER	DEBE	HABER
12351002022001026002	CONTRATO	0.00		2,142,873.63		2,142,873.63	0.00
12351002022001026002023	AMPLIACION DE LA RED DE ELECTRICA EN LAS CALLES AMA-POLAS Y PETUNIAS, DE LA COLONIA FLORIDA, DE LA LOC. DE CHILPANCINGO, MUNICIPIO DE CHILPANCINGO DE LOS BRAVO GRO.	0.00		485,592.56		485,592.56	0.00
12351002022001026002024	AMPLIACION DE LA RED DE ELECTRICA EN EL CIRCUITO CUITLAHUAC, DE LA COLONIA RENOVACION, DE LA LOC. DE CHILPANCINGO, MUNICIPIO DE CHILPANCINGO DE LOS BRAVO GRO.	0.00		244,702.81		244,702.81	0.00
12351002022001026002025	AMPLIACION DE LA RED DE ELECTRICA EN LA CALLE LINALOE, DE LA COLONIA ALBORADA, DE LA LOC. DE CHILPANCINGO, MUNICIPIO DE CHILPANCINGO DE LOS BRAVO GRO.	0.00		314,400.60		314,400.60	0.00
12351002022001026002026	AMPLIACION DE LA RED DE ELECTRICA EN LA CALLE LINDA VISTA, DE LA COLONIA MIRABAL, DE LA LOC. DE CHILPANCINGO, MUNICIPIO DE CHILPANCINGO DE LOS BRAVO GRO.	0.00		285,583.68		285,583.68	0.00
12351002022001026002027	AMPLIACION DE LA RED DE ELECTRICA EN LA CALLE MELCHOR OCAMPO EN EL BARRIO DE SANTA CRUZ DE LA LOC. DE PETAQUILLAS, MUNICIPIO DE CHILPANCINGO DE LOS BRAVO GRO.	0.00		531,586.64		531,586.64	0.00
12351002022001026002028	AMPLIACION DE LA RED DE ELECTRICA EN LA COLONIA TLACOMULCO, DE LA LOC. DE CHILPANCINGO, MUNICIPIO DE CHILPANCINGO DE LOS BRAVO GRO.	0.00		281,007.34		281,007.34	0.00
12352	FONDO DE APORTACION PARA LA INFRAESTRUCTURA SOCIAL MUNICIPAL	0.00		25,729,316.16		25,729,316.16	0.00
12352022	EDIFICACION NO HABITACIONAL EN PROCESO	0.00		25,729,316.16		25,729,316.16	0.00
12352022001	INFRAESTRUCTURA BASICA DE SALUD	0.00		3,457,162.48		3,457,162.48	0.00
12352022001026002	EJERCICIO 2019	0.00		3,457,162.48		3,457,162.48	0.00
12352022001026002001	CONTRATO	0.00		965,046.28		965,046.28	0.00
12352022001026002002	CONSTRUCCION DE DISPENSARIO MEDICO EN LA LOC. DE RINCON DE LA VIA, MUNICIPIO DE CHILPANCINGO DE LOS BRAVO, ESTADO DE GUERRERO	0.00		923,548.76		923,548.76	0.00
12352022001026002003	CONSTRUCCION DE DISPENSARIO MEDICO EN LA LOC. RINCON DE ALCAPARROSA, MUNICIPIO DE CHILPANCINGO DE LOS BRAVO, ESTADO DE GUERRERO	0.00		1,568,567.44		1,568,567.44	0.00
12352022002	CONTRUCCION DE CENTRO DE SALUD SEGUNDA ETAPA EN LA LOCALIDAD DE JULIAN BLANCO, MUNICIPIO DE CHILPANCINGO DE LOS BRAVO, GUERRERO	0.00		22,272,153.68		22,272,153.68	0.00
12352022002026	INFRAESTRUCTURA BASICA DE EDUCACION	0.00		22,272,153.68		22,272,153.68	0.00
	EJERCICIO 2019	0.00		22,272,153.68		22,272,153.68	0.00

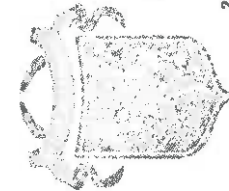
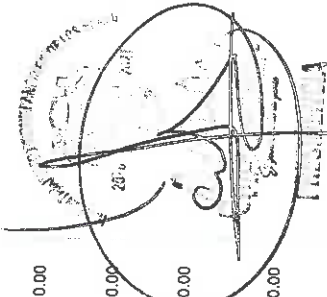

H. Ayuntamiento Municipal, Constituido por el Cabildo Municipal de Chilpancingo, Gro. Contraloría Municipal



H. AYUNTAMIENTO MUNICIPAL DE CHILPANCINGO, GRO.

SECRETARIA DE FINANZAS Y ADMINISTRACION

CONSOLIDADO



BALANZA DE COMPROBACIÓN DEL 1 DE ENERO AL 31 DE DICIEMBRE DEL 2019

C U E N T A	C O N C E P T O	SALDOS INICIALES		M O V I M I E N T O S		SALDOS ACUMULADOS	
		AL 1 DE ENERO DE 2019		ENERO - DICIEMBRE 2019		AL 31 DE DICIEMBRE DE 2019	
		DEBE	HABER	DEBE	HABER	DEBE	HABER
12352022002026002	CONTRATO	0.00		22,272,153.68		22,272,153.68	0.00
12352022002026002001	CONSTRUCCIÓN DE AULA PARA IMPARTICIÓN DE EDUCACIÓN FÍSICA, EN LA ESCUELA TELESECUNDARIA NICOLAS BRAVO DE LA LOC. DE ACAHUIZOTLA, MPIO. DE CHILPANCINGO DE LOS BRAVO, GUERRERO.	0.00		1,517,226.35		1,517,226.35	0.00
12352022002026002002	JARDIN DE NIÑOS CARTINO MALDONADO, DE LA COL. CNOP, EN LA LOCALIDAD DE CHILPANCINGO DE LOS BRAVO, ESTADO DE GUERRERO.	0.00		906,960.95		906,960.95	0.00
12352022002026002003	CONSTRUCCION DE COMEDOR ESCOLAR EN ESC PRIM EN LA LOC DE CARRIZAL DEL PINZON, EN EL MUNICIPIO DE CHILPANCINGO GRO	0.00		1,680,500.00		1,680,500.00	0.00
12352022002026002004	CONSTRUCCION DE COMEDOR ESCOLAR EN LA ESC. PRIM. DE LA LOC. DE RENACIMIENTO AGUA HERNANDEZ MPIO. DE CHILPANCINGO DE LOS BRAVO, ESTADO DE GUERRERO	0.00		1,077,455.13		1,077,455.13	0.00
12352022002026002005	CONSTRUCCION DE COMEDOR ESCOLAR EN LA LOCALIDAD DE TEPECHICOTLAN, MUNICIPIO DE CHILPANCINGO DE LOS BRAVO, ESTADO DE GUERRERO	0.00		1,437,097.54		1,437,097.54	0.00
12352022002026002006	CONSTRUCCION DE COMEDOR ESCOLAR EN EL JARDIN DE NIÑOS FRIDA KAHLO DE LA LOC. DE CAJELITOS, MUNICIPIO DE CHILPANCINGO DE LOS BRAVO, ESTADO DE GUERRERO	0.00		530,186.33		530,186.33	0.00
12352022002026002007	CONSTRUCCION DE BARRA PERIMETRAL EN LA ESC. PRIM. "VICENTE GUERRERO" DE LA LOCALIDAD DE RIO VERDE, MUNICIPIO DE CHILPANCINGO DE LOS BRAVO, ESTADO DE GUERRERO	0.00		718,355.27		718,355.27	0.00
12352022002026002008	CONSTRUCCION DE COMEDOR EN EL TELEBACHILLERATO DE LA LOC. DE COACUYULILO, MPIO. DE CHILPANCINGO DE LOS BRAVO, ESTADO DE GUERRERO	0.00		1,258,289.86		1,258,289.86	0.00
12352022002026002009	CONSTRUCCION DE AULA PARA IMPARTICION FISICA, EN LA ESCUELA TELESECUNDARIA NICOLAS BRAVO DE LA LOC. DE ACAHUIZOTLA, MPIO DE CHILPANCINGO DE LOS BRAVO, GUERRERO	0.00		486,390.13		486,390.13	0.00
12352022002026002010	CONSTRUCCION DE COMEDOR ESCOLAR EN LA ESC. PRIM. DE LA LOC. DE CHICAHUALES, MPIO DE CHILPANCINGO DE LOS BRAVO	0.00		1,277,264.24		1,277,264.24	0.00
12352022002026002011	CONSTRUCCION DE COMEDOR ESCOLAR EN LA ESC. PRIM. EMPERADOR CUAUHTEMOC, DE LA COL. GUERRERO 200, EN LA LOCALIDAD DE CHILPANCINGO DE LOS BRAVO, ESTADO DE GUERRERO	0.00		1,118,402.05		1,118,402.05	0.00
12352022002026002012	CONSTRUCCION DE COMEDOR ESCOLAR EN EL TELEBACHILLERATO COMUNITARIO 036 DE LA COMUNIDAD DE ACAHUIZOTLA, MUNICIPIO DE CHILPANCINGO DE LOS BRAVO, ESTADO DE GUERRERO	0.00		1,428,706.46		1,428,706.46	0.00

H. AYUNTAMIENTO MUNICIPAL DE CHILPANCINGO
   
 SECRETARIA DE FINANZAS Y ADMINISTRACION



H. Ayuntamiento Municipal Constitucional de Chilpancingo, Gro.  
 CONTRALORIA VICERECTOR MUNICIPAL



H. AYUNTAMIENTO MUNICIPAL DE CHILPANCINGO, GRO.

SECRETARIA DE FINANZAS Y ADMINISTRACION

CONSOLIDADO



BALANZA DE COMPROBACION DEL 1 DE ENERO AL 31 DE DICIEMBRE DEL 2019

C U E N T A	C O N C E P T O	SALDOS INICIALES		M O V I M I E N T O S		SALDOS ACUMULADOS	
		AL 1 DE ENERO DE 2019		ENERO - DICIEMBRE 2019		AL 31 DE DICIEMBRE DE 2019	
		DEBE	HABER	DEBE	HABER	DEBE	HABER
12352022002026002013	CONSTRUCCION DE COMEDOR ESCOLAR EN LA ESC. PRIM. VICENTE GUERRERO DE LA LOC. DE MOHNERAS, MPIO. DE CHILPANCINGO DE LOS BRAVO, ESTADO DE GUERRERO	0.00		833,809.74	833,809.74	0.00	0.00
12352022002026002014	CONSTRUCCION DE BANDA PERIMETRAL EN EL CENTRO DE BACHILLERATO TECNOLOGICO AGROPECUARIO N° 225 DE LA LOC. DE BUENA VISTA, MPIO. DE CHILPANCINGO DE LOS BRAVO, ESTADO DE GUERRERO	0.00		621,035.49	621,035.49	0.00	0.00
12352022002026002015	CONSTRUCCION DE COMEDOR ESCOLAR EN LA ESC. PRIM. JOSE MARTI, COL. CAMINOS, EN CHILPANCINGO DE LOS BRAVO, GRO.	0.00		514,299.98	514,299.98	0.00	0.00
12352022002026002016	CONSTRUCCION DE TECHADO EN AREA DE PARTICION DE EDUCACION FISICA EN LA ESC. PRIM. LEONA VICARIO, EN LA COLONIA ATLACENCO DE ALTAMIRA, LOC. DE CHILPANCINGO, MUNICIPIO DE CHILPANCINGO DE LOS BRAVO.	0.00		1,080,173.64	1,080,173.64	0.00	0.00
12352022002026002017	CONSTRUCCION DE TECHADO EN AREA DE PARTICION DE EDUCACION FISICA EN LA ESC. PRIM. 18 DE MARZO CON C.C.T. 12DPR0418X, EN LA COLONIA AMPLIACION LAZARO CARDENAS, LOC. DE CHILPANCINGO, MUNICIPIO DE CHILPANCINGO DE LOS BRAVO.	0.00		980,746.53	980,746.53	0.00	0.00
12352022002026002018	CONSTRUCCION DE TECHADO EN AREA DE PARTICION DE EDUCACION FISICA EN EL JARDIN DE NIÑOS ANNA FREUD C.C.T. 12DJN2846N EN LA CALLE CHIAPAS, EN LA COLONIA LOMAS DE XOCOMULCO, LOC. DE CHILPANCINGO, MUNICIPIO DE CHILPANCINGO DE LOS BRAVO.	0.00		781,777.64	781,777.64	0.00	0.00
12352022002026002019	CONSTRUCCION DE COMEDOR ESCOLAR EN LA ESC. PRIM. LUIS CORDOVA REYES CON C.C.T. 12DPR5970W EN LA COLONIA WENCESLAD SOTO, LOC. DE CHILPANCINGO, MUNICIPIO DE CHILPANCINGO DE LOS BRAVO.	0.00		1,105,998.59	1,105,998.59	0.00	0.00
12352022002026002020	CONSTRUCCION DE BANDA PERIMETRAL EN EL JARDIN DE NIÑOS AARON M. FLORES MOCTEZUMA CON C.C.T. 12DJN0219H EN LA COLONIA PRIMER CONGRESO DE ANAHUAC, LOC. DE CHILPANCINGO, MUNICIPIO DE CHILPANCINGO DE LOS BRAVO.	0.00		289,659.25	289,659.25	0.00	0.00
12352022002026002021	CONSTRUCCION DE BANDA PERIMETRAL EN LA ESCUELA PRIMARIA EUCARIA APREZA GARCIA CON C.C.T. 12EPR0005W EN LA COLONIA PPS, LOC. DE CHILPANCINGO, MUNICIPIO DE CHILPANCINGO DE LOS BRAVO.	0.00		481,406.13	481,406.13	0.00	0.00
12352022002026002022	CONSTRUCCION DE AULA TIPO REGIONAL EN EL JARDIN DE NIÑOS "NIÑOS HEROES" CON C.C.T. 12EJN0589F EN LA COLONIA LIC. NORBERTO FLORES BAÑOS, LOC. DE CHILPANCINGO, MUNICIPIO DE CHILPANCINGO DE LOS BRAVO.	0.00		525,336.89	525,336.89	0.00	0.00

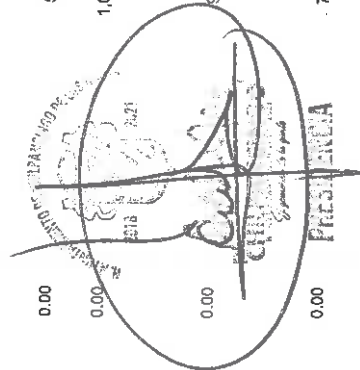

Ayuntamiento Municipal Constitucional de Chilpancingo  
CONTRALORIA INTERNA MUNICIPAL



H. AYUNTAMIENTO MUNICIPAL DE CHILPANCINGO, GRO.

SECRETARIA DE FINANZAS Y ADMINISTRACION

CONSOLIDADO



BALANZA DE COMPROBACIÓN DEL 1 DE ENERO AL 31 DE DICIEMBRE DEL 2019

C U E N T A	C O N C E P T O	SALDOS INICIALES		MOVIMIENTOS		SALDOS ACUMULADOS	
		AL 1 DE ENERO DE 2019		ENERO - DICIEMBRE 2019		AL 31 DE DICIEMBRE DE 2019	
		DEBE	HABER	DEBE	HABER	DEBE	HABER
12352022002026002024	CONSTRUCCION DE AULA TIPO REGIONAL EN EL TELEBACHILLERATO COMUNITARIO PLANTEL 039 CON C.C.T. 12ETK0039F EN LA LOC. DE INSCUINATOYAC. MUNICIPIO DE CHILPANCINGO DE LOS BRAVO.	0.00		531,213.74		531,213.74	0.00
12352022002026002025	JARDIN DE NIÑOS "JEAN PIAGET" CON C.C.T. 12EJN0017K EN LA LOC. DE CHILPANCINGO. MUNICIPIO DE CHILPANCINGO DE LOS BRAVO.	0.00		634,861.85		634,861.85	0.00
12352022002026002026	CONSTRUCCION DE CANCHA DEPORTIVA EN LA LOCALIDAD DE RIO VERDE. MUNICIPIO DE CHILPANCINGO DE LOS BRAVO, ESTADO DE GUERRERO	0.00		455,000.00		455,000.00	0.00
12353	CONSTRUCCIÓN DE OBRAS PARA EL ABASTECIMIENTO DE AGUA, PETRÓLEO, GAS, ELECTRICIDAD Y TELECOMUNICACIONES EN PROCESO	0.00					
12353022	FONDO DE APORTACION PARA LA INFRAESTRUCTURA SOCIAL MUNICIPAL AGUA Y SANEAMIENTO	0.00		88,948,658.30		88,948,658.30	0.00
12353022002	EJERCICIO 2019	0.00					
12353022002026002001	CONTRATO	0.00					
12353022002026002002	REHABILITACION DE ALCANTARILLADO SANITARIO; INTRODUCCION DE RED DE DISTRIBUCION DE AGUA POTABLE Y CANALIZACION DE AGUAS PLUVIALES CON CONCRETO HIDRAULICO DE LA CALLE LAURELES DE LA COL. LOMAS DEL PONIENTE DE LA CIUDAD DE CHILPANCINGO DE LOS BRAVO, ESTADO DE GUERRERO.	0.00		85,135,272.13		85,135,272.13	0.00
12353022002026002003	REHABILITACION DE ALCANTARILLADO SANITARIO Y CANALIZACION DE AGUAS PLUVIALES CON CONCRETO HIDRAULICO EN LA SEGUNDA ETAPA EN LA COL. HUACAPITA DE LA CIUDAD DE CHILPANCINGO DE LOS BRAVO, DESAZOLVE DEL ALCANTARILLADO PLUVIAL PRIMERA ETAPA EN LA COLONIA GALEANA TRAMO: DEPORTIVO LOS GALEANA - CALLE INDUSTRIAL COL. SAN RAFAEL NORTE, EN LA CIUDAD DE CHILPANCINGO DE LOS BRAVO,	0.00		85,135,272.13		85,135,272.13	0.00
12353022002026002004	REHABILITACION DE ALCANTARILLADO SANITARIO Y CANALIZACION DE AGUAS PLUVIALES CON CONCRETO HIDRAULICO EN LA SEGUNDA ETAPA EN LA COL. HUACAPITA DE LA CIUDAD DE CHILPANCINGO DE LOS BRAVO, DESAZOLVE DEL ALCANTARILLADO PLUVIAL PRIMERA ETAPA EN LA COLONIA GALEANA TRAMO: DEPORTIVO LOS GALEANA - CALLE INDUSTRIAL COL. SAN RAFAEL NORTE, EN LA CIUDAD DE CHILPANCINGO DE LOS BRAVO,	0.00		1,305,454.78		1,305,454.78	0.00
		0.00		671,795.73		671,795.73	0.00
		0.00		983,139.18		983,139.18	0.00
		0.00		1,285,755.23		1,285,755.23	0.00

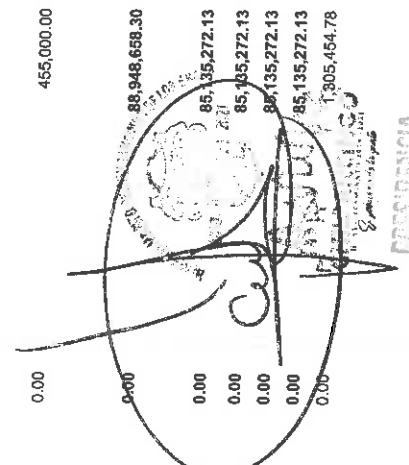
  
 PRESIDENCIA



Ayuntamiento Municipal Constitucional de  
 Chilpancingo, Gro.  
 CONTRALORIA FISCAL MUNICIPAL





H. AYUNTAMIENTO MUNICIPAL DE CHILPANCINGO, GRO.  
SECRETARIA DE FINANZAS Y ADMINISTRACION  
CONSOLIDADO



BALANZA DE COMPROBACIÓN DEL 1 DE ENERO AL 31 DE DICIEMBRE DEL 2019

C U E N T A	C O N C E P T O	SALDOS INICIALES		M O V I M I E N T O S		SALDOS ACUMULADOS	
		AL 1 DE ENERO DE 2019		ENERO - DICIEMBRE 2019		AL 31 DE DICIEMBRE DE 2019	
		DEBE	HABER	DEBE	HABER	DEBE	HABER
12353022002026002005	GUERRERO. DESAROLVE DEL ALCANTARILLADO PLUVIAL SEGUNDA ETAPA EN LA COLONIA SAN RAFAEL NORTE TRAMO: CALLE INDUSTRIAL - COL. AMPLIACION LAZARO CARDENAS, EN LA CIUDAD DE CHILPANCINGO DE LOS BRAVO, GUERRERO. CANALIZACION DE AGUAS PLUVIALES CON CONCRETO HIDRAULICO EN LA CALLE BELIZARIO DOMINGUEZ DEL BARRIO DE SAN MATEO TRAMO: NARCISO MENDOZA - MELCHOR OCAMPO EN CHILPANCINGO DE LOS BRAVO, GUERRERO. CONSTRUCCION DE DRENAJE SANITARIO EN LA COLONIA EL HUAJAL, EN CHILPANCINGO DE LOS BRAVO, GUERRERO.	0.00		1,000,000.00		1,000,000.00	0.00
12353022002026002006	CANALIZACION DE AGUAS PLUVIALES CON CONCRETO HIDRAULICO EN LA CALLE GABRIEL LEIVA ALARCON DE LA COL. SAN RAFAEL ORIENTE DE CHILPANCINGO DE LOS BRAVO, ESTADO DE GUERRERO.	0.00		104,253.35		104,253.35	0.00
12353022002026002007	CANALIZACION DE AGUAS PLUVIALES CON CONCRETO HIDRAULICO EN LA CALLE GABRIEL LEIVA ALARCON DE LA COL. SAN RAFAEL ORIENTE DE CHILPANCINGO DE LOS BRAVO, ESTADO DE GUERRERO.	0.00		701,788.77		701,788.77	0.00
12353022002026002009	CONSTRUCCION DE CAJAS TIPO POZO EN LA RED DE ALCANTARILLADO SANITARIO EN LA AV. JOSE FRANCISCO RUIZ MASSIEU DE LA COL. VILLA MODERNA, DE CHILPANCINGO DE LOS BRAVO, EN EL ESTADO DE GUERRERO.	0.00		1,000,000.00		1,000,000.00	0.00
12353022002026002011	CANALIZACION DE AGUAS PLUVIALES CON CONCRETO HIDRAULICO EN LA CALLE PABLO SANDOVAL DE LA COL. PRD. EN LA LOCALIDAD DE CHILPANCINGO DE LOS BRAVO, ESTADO DE GUERRERO.	0.00		147,295.66		147,295.66	0.00
12353022002026002014	CANALIZACION DE AGUAS PLUVIALES CON CONCRETO HIDRAULICO EN LA CALLE JOSE MA. IZAZAGA DE LA COL. GUERRERO 200, EN LA LOCALIDAD DE CHILPANCINGO DE LOS BRAVO, ESTADO DE GUERRERO.	0.00		1,156,325.00		1,156,325.00	0.00
12353022002026002013	CANALIZACION DE AGUAS PLUVIALES CON CONCRETO HIDRAULICO EN EL ACCESO PRINCIPAL A LA LOC. DE TEJOCOTE, MPIO. DE CHILPANCINGO DE LOS BRAVO, ESTADO DE GUERRERO.	0.00		1,128,000.00		1,128,000.00	0.00
12353022002026002014	CANALIZACION DE AGUAS PLUVIALES CON CONCRETO HIDRAULICO EN EL ACCESO PRINCIPAL DEL FRACCIONAMIENTO DON ELY DE LA LOCALIDAD DE CHILPANCINGO DE LOS BRAVO, ESTADO DE GUERRERO.	0.00		987,573.00		987,573.00	0.00
12353022002026002015	CANALIZACION DE AGUAS PLUVIALES CON CONCRETO HIDRAULICO EN EL ACCESO PRINCIPAL AL CENTRO DE SALUD DE LA LOC. DE OCOTITO, MPIO. DE CHILPANCINGO DE LOS BRAVO, ESTADO DE GUERRERO.	0.00		1,000,000.00		1,000,000.00	0.00
12353022002026002015	REHABILITACION DE ALCANTARILLADO SANITARIO EN LA CALLE HEROICO COLEGIO MILITAR DE LA COL. ALIANZA POPULAR, DE	0.00		800,307.20		800,307.20	0.00
		0.00		265,369.30		265,369.30	0.00

*[Handwritten signature and official stamp]*



H. Ayuntamiento Municipal de Chilpancingo, Gro.





H. AYUNTAMIENTO MUNICIPAL DE CHILPANCINGO, GRO.

SECRETARIA DE FINANZAS Y ADMINISTRACION

CONSOLIDADO



BALANZA DE COMPROBACION DEL 1 DE ENERO AL 31 DE DICIEMBRE DEL 2019

C U E N T A	C O N C E P T O	SALDOS INICIALES		M O V I M I E N T O S		SALDOS ACUMULADOS	
		AL 1 DE ENERO DE 2019		ENERO - DICIEMBRE 2019		AL 31 DE DICIEMBRE DE 2019	
		DEBE	HABER	DEBE	HABER	DEBE	HABER
12353022002026002016	CHILPANCINGO DE LOS BRAVO, EN EL ESTADO DE GUERRERO CANALIZACION DE AGUAS PLUVIALES CON CONCRETO HIDRAULICO EN LA CALLE PRINCIPAL DE LA LOC. DE SAN VICENTE, MPIO. DE CHILPANCINGO DE LOS BRAVO, ESTADO DE GUERRERO	0.00		800,000.00	800,000.00	0.00	
12353022002026002017	CONSTRUCCION DE LA OBRA DE TOMA DE AGUA POTABLE DE LA LOCALIDAD DE AZINAHUALCO; MUNICIPIO DE CHILPANCINGO DE LOS BRAVO, ESTADO DE GUERRERO	0.00		793,405.01	793,405.01	0.00	
12353022002026002018	CANALIZACION DE AGUAS PLUVIALES EN LA BARRANCA DE EL LLANO DE LA COL. JARDIN DE LA LOCALIDAD DE MAZATLAN, MPIO. DE CHILPANCINGO DE LOS BRAVO, ESTADO DE GUERRERO	0.00		898,544.19	898,544.19	0.00	
12353022002026002019	CANALIZACION DE AGUAS PLUVIALES CON CONCRETO HIDRAULICO DE LA CALLE 16 DE SEPTIEMBRE, EN LA LOCALIDAD DE CHILPANCINGO DE LOS BRAVO, MUNICIPIO DE CHILPANCINGO DE LOS BRAVO, ESTADO DE GUERRERO	0.00		940,773.31	940,773.31	0.00	
12353022002026002020	CANALIZACION DE AGUAS PLUVIALES CON CONCRETO HIDRAULICO EN LA CALLE BRIGAMBIAS DEL FRACCIONAMIENTO SANTA ROSA, EN LA LOCALIDAD DE PETAQUILLAS, MPIO DE CHILPANCINGO DE LOS BRAVO, ESTADO DE GUERRERO	0.00		861,218.99	861,218.99	0.00	
12353022002026002021	CONSTRUCCION DE ALCANTARILLADO SANITARIO Y PAVIMENTACION CON CONCRETO HIDRAULICO EN LA CALLE DEL PANTEON DE LA LOC. DE AMOJILECA, MPIO. DE CHILPANCINGO DE LOS BRAVO, ESTADO DE GUERRERO	0.00		1,540,111.68	1,540,111.68	0.00	
12353022002026002022	CANALIZACION DE AGUAS PLUVIALES CON CONCRETO HIDRAULICO EN LA CALLE AV. CHILPANCINGO DE LA COL. DIANA LAURA, MPIO DE CHILPANCINGO DE LOS BRAVO, ESTADO DE GUERRERO	0.00		716,756.49	716,756.49	0.00	
12353022002026002024	CANALIZACION DE AGUAS PLUVIALES CON CONCRETO HIDRAULICO EN EL ACCESO PRINCIPAL DE LA COLONIA IGNACIO MANUEL ALTAMIRANO, EN LA LOCALIDAD DE CHILPANCINGO DE LOS BRAVO, ESTADO DE GUERRERO	0.00		928,552.70	928,552.70	0.00	
12353022002026002025	CANALIZACION DE AGUAS PLUVIALES CON CONCRETO HIDRAULICO EN LA CALLE MANZANO DE LA COL. GUADALUPE DE CHILPANCINGO DE LOS BRAVO, ESTADO DE GUERRERO	0.00		985,894.03	985,894.03	0.00	
12353022002026002026	CANALIZACION DE AGUAS PLUVIALES CON CONCRETO HIDRAULICO EN LA CALLE ANDRES MANUEL LOPEZ OBRADOR DE LA COL. PRD, EN LA LOCALIDAD DE CHILPANCINGO DE LOS BRAVO, ESTADO DE GUERRERO	0.00		744,229.56	744,229.56	0.00	
12353022002026002027	CANALIZACION DE AGUAS PLUVIALES CON	0.00		826,862.63	826,862.63	0.00	

*[Handwritten signature and official stamp of the Municipal Secretary of Finance and Administration]*



H. Ayuntamiento Municipal, Institucional de  
CONTABILIDAD MUNICIPAL



H. AYUNTAMIENTO MUNICIPAL DE CHILPANCINGO, GRO.

SECRETARIA DE FINANZAS Y ADMINISTRACION

CONSOLIDADO



BALANZA DE COMPROBACIÓN DEL 1 DE ENERO AL 31 DE DICIEMBRE DEL 2019

C U E N T A	C O N C E P T O	SALDOS INICIALES		M O V I M I E N T O S		SALDOS ACUMULADOS	
		AL 1 DE ENERO DE 2019		ENERO - DICIEMBRE 2019		AL 31 DE DICIEMBRE DE 2019	
		DEBE	HABER	DEBE	HABER	DEBE	HABER
12353022002026002028	CONCRETO HIDRAULICO EN LA CALLE SIN NOMBRE DE LA COL. DOCTOR SAUL ALARCON ABARCA, DE CHILPANCINGO DE LOS BRAVO, ESTADO DE GUERRERO CANALIZACION DE AGUAS PLUVIALES CON CONCRETO HIDRAULICO EN LA CALLE PRINCIPAL EN LA COLONIA SANTO DOMINGO, EN LA LOCALIDAD DE CHILPANCINGO, MUNICIPIO DE CHILPANCINGO DE LOS BRAVO, ESTADO DE GUERRERO	0.00		796,428.62	796,428.62	0.00	0.00
12353022002026002029	CONSTRUCCION DE RED DE ALCANTARILLADO SANITARIO EN LA CALLE SIN NOMBRE DE LA LOC. LOS PETACUILLAS, MPIO DE CHILPANCINGO DE LOS BRAVO, ESTADO DE GUERRERO	0.00		382,329.64	382,329.64	0.00	0.00
12353022002026002030	CANALIZACION DE AGUAS PLUVIALES CON CONCRETO HIDRAULICO EN LA CALLE COL. SAN RAFAEL NORTE, EN LA LOCALIDAD DE CHILPANCINGO DE LOS BRAVO, ESTADO DE GUERRERO	0.00		754,317.42	754,317.42	0.00	0.00
12353022002026002031	CANALIZACION DE AGUAS PLUVIALES CON CONCRETO HIDRAULICO EN LA CALLE PRINCIPAL DE LA COLONIA VALLE DE LAS FLORES PRIMERA ETAPA, EN LA LOCALIDAD DE CHILPANCINGO DE LOS BRAVO, ESTADO DE GUERRERO	0.00		795,111.53	795,111.53	0.00	0.00
12353022002026002032	CANALIZACION DE AGUAS PLUVIALES CON CONCRETO HIDRAULICO EN LA CALLE 24 DE FEBRERO PRIMER ETAPA EN LA COL. DE GUERRERO MOVIMIENTO TERRITORIAL URBANO POPULAR EN LA LOCALIDAD DE CHILPANCINGO DE LOS BRAVO, ESTADO DE GUERRERO	0.00		737,710.32	737,710.32	0.00	0.00
12353022002026002034	CANALIZACION DE AGUAS PLUVIALES CON CONCRETO HIDRAULICO, EN LA CALLE RIO BALSAS, COL. AMPLIACION PINO SUAREZ, EN CHILPANCINGO DE LOS BRAVO, GRO.	0.00		398,700.69	398,700.69	0.00	0.00
12353022002026002035	CANALIZACION DE AGUAS PLUVIALES CON CONCRETO HIDRAULICO, EN EL ACCESO RUTA HUAMUCHIL, COL. TELUMBRE, EN CHILPANCINGO DE LOS BRAVO, GRO.	0.00		1,050,561.11	1,050,561.11	0.00	0.00
12353022002026002036	CONSTRUCCION DE RED DE DRENAJE SANITARIO Y FOSA SEPTICA EN LA LOCALIDAD DE TLAHUZAPA, MPIO. DE CHILPANCINGO DE LOS BRAVO, ESTADO DE GUERRERO	0.00		1,049,896.49	1,049,896.49	0.00	0.00
12353022002026002037	REHABILITACION DE LA OBRA DE TOMA Y LINEA DE CONDUCCION DE AGUA POTABLE DE LA LOC. DE HUACAUAPA, MPIO. DE CHILPANCINGO DE LOS BRAVO, ESTADO DE GUERRERO	0.00		331,955.05	331,955.05	0.00	0.00
12353022002026002038	CANALIZACION DE AGUAS PLUVIALES CON CONCRETO HIDRAULICO DE ANDADOR Y ACCESO A BARRANCA EN LA COLONIA AMPLIACION JARDINES DEL SUR, EN LA LOCALIDAD DE CHILPANCINGO DE LOS BRAVO, ESTADO DE GUERRERO	0.00		696,702.91	696,702.91	0.00	0.00

SECRETARIA DE FINANZAS Y ADMINISTRACION  
 H. AYUNTAMIENTO MUNICIPAL DE CHILPANCINGO, GRO.  
 CONTRALORIA INTERNA MUNICIPAL



H. Ayuntamiento Municipal Constitucional de Chilpancingo, Gro.  
 CONTRALORIA INTERNA MUNICIPAL



H. AYUNTAMIENTO MUNICIPAL DE CHILPANCINGO, GRO.

SECRETARIA DE FINANZAS Y ADMINISTRACION

CONSOLIDADO



BALANZA DE COMPROBACIÓN DEL 1 DE ENERO AL 31 DE DICIEMBRE DEL 2019

C U E N T A	C O N C E P T O	SALDOS INICIALES		M O V I M I E N T O S		SALDOS ACUMULADOS	
		AL 1 DE ENERO DE 2019		ENERO - DICIEMBRE 2019		AL 31 DE DICIEMBRE DE 2019	
		DEBE	HABER	DEBE	HABER	DEBE	HABER
1 2 3 5 3 0 2 2 0 0 2 0 2 6 0 0 2 0 3 9	GUERRERO CANALIZACION DE AGUAS PLUVIALES CON CONCRETO HIDRAULICO EN LA CALLE GRAL. R. LEYVA MANCILLA DE LA COL. VILLAS DE LEYVA, EN LA LOCALIDAD DE CHILPANCINGO DE LOS BRAVO, ESTADO DE GUERRERO CONSTRUCCION DE SISTEMA DE DRENAJE DE LA CALLE 21 DE MARZO, EN LA LOCALIDAD DE CHILPANCINGO, MUNICIPIO DE CHILPANCINGO DE LOS BRAVO. SUSTITUCION DE 2 EQUIPOS DE BOMBEO DE 75HP, 2 TRENES DE DESCARGA DE 6" CONSTRUCCION DE 1,231.52m DE LINEA DE CONDUCCION DE 8" DE ACERO, CONSTRUCCION DE TANQUE DE 500 M3, CASETA Y EQUIPO DE CLORACION, DEL SISTEMA DE AGUA POTABLE EN LA LOCALIDAD DE PETAQUILLAS, MUNICIPIO DE CHILPANCINGO DE LOS BRAVO, PRIMERA ETAPA DE REHABILITACION DE 1.6 KM DE TUBERIA DE PVC DE 18", 12" Y 8" DE DIAMETRO Y 2018 DESCARGAS DOMICILIARIAS EN LA CALLE TULIPANES (TMO. CALLE TULIPANES-ENCAUZAMIENTO HUACAPA) Y 0.98 KM DE TUBERIA PVC DE 12" DE DIAMETRO Y 85 DESCARGAS DOMICILIARIAS EN AV. RUFFO FIGUEROA Y GOBERNADORES (TMO. FIGUEROA Y GOBERNADORES (TMO. JACARANDAS-LA CURVA) EN LA LOC. DE CHILPANCINGO, MUNICIPIO DE CHILPANCINGO DE LOS BRAVO. SUMINISTRO E INSTALACION DE 395.98 M. DE TUBERIA DE PVC Y ACERO DE 12" DE DIAMETRO, SUMINISTRO E INSTALACION DE 725 M. DE TUBERIA DE PVC DE 8" DE DIAMETRO, SUMINISTRO E INSTALACION DE 2,624.96 M. DE TUBERIA DE PVC Y ACERO DE 4" DE DIAMETRO, CONSTRUCCION DE 503 TOMAS DOMICILIARES Y SUMINISTRO E INSTALACION DE 2 EQUIPOS DE BOMBEO (TOMATAL Y VALLE ESMERALDA) EN LA LOC. DE CHILPANCINGO, MUNICIPIO DE CHILPANCINGO DE LOS BRAVO. CONSTRUCCION DE 2.38 KM DE TUBERIA DE PVC DE 4" Y 3" DE DIAMETRO Y 359 TOMAS DOMICILIARIAS EN LA ZONA ORIENTE (COLONIAS MEXICO, REVOLUCION Y NUEVA REVOLUCION) EN LA LOC. DE CHILPANCINGO, MUNICIPIO DE CHILPANCINGO DE LOS BRAVO. CONSTRUCCION DE LINEA DE CONDUCCION DE AGUA POTABLE EN LA LOCALIDAD DE ZOYATEPEC, MUNICIPIO DE CHILPANCINGO DE LOS BRAVO GRO. REHABILITACION DE RED DE ALCANTARILLADO SANITARIO Y PAVIMENTACION CON CONCRETO HIDRAULICO EN LA CALLE LOS FRESNOS, TRAMO:	0.00		735,198.75		735,198.75	0.00
1 2 3 5 3 0 2 2 0 0 2 0 2 6 0 0 2 0 4 0		0.00		7,787,500.00		7,787,500.00	0.00
1 2 3 5 3 0 2 2 0 0 2 0 2 6 0 0 2 0 4 1		0.00		2,149,738.63		2,149,738.63	0.00
1 2 3 5 3 0 2 2 0 0 2 0 2 6 0 0 2 0 4 2		0.00		1,968,527.51		1,968,527.51	0.00
1 2 3 5 3 0 2 2 0 0 2 0 2 6 0 0 2 0 4 3		0.00		8,040,145.70		8,040,145.70	0.00
1 2 3 5 3 0 2 2 0 0 2 0 2 6 0 0 2 0 4 4		0.00		2,310,916.74		2,310,916.74	0.00
1 2 3 5 3 0 2 2 0 0 2 0 2 6 0 0 2 0 4 5		0.00		1,662,601.38		1,662,601.38	0.00
1 2 3 5 3 0 2 2 0 0 2 0 2 6 0 0 2 0 4 6		0.00		828,348.32		828,348.32	0.00

Coram/ Balanza

6.08.08 PM

miércoles 25 marzo 2020



H. AYUNTAMIENTO MUNICIPAL DE CHILPANCINGO, GRO.

SECRETARIA DE FINANZAS Y ADMINISTRACION

CONSOLIDADO



BALANZA DE COMPROBACIÓN DEL 1 DE ENERO AL 31 DE DICIEMBRE DEL 2019

C U E N T A	C O N C E P T O	SALDOS INICIALES		MOVIMIENTOS		SALDOS ACUMULADOS	
		AL 1 DE ENERO DE 2019		ENERO - DICIEMBRE 2019		AL 31 DE DICIEMBRE DE 2019	
		DEBE	HABER	DEBE	HABER	DEBE	HABER
12353022002026002047	CALLE LOS SAUCES-CALLE UNION Y PROGRESO DE LA COLONIA EL ENCANTO, EN LA LOC. DE CHILPANCINGO, MUNICIPIO DE CHILPANCINGO DE LOS BRAVO GRO. REHABILITACION DE RED DE DRENAJE SANITARIO Y CONSTRUCCION DE CALLE CON CONCRETO HIDRAULICO EN LA CALLE BRASIL TRAMO: CALLE COSTA RICA-CALLE GUATEMALA, DE LA COLONIA ROSARIO IBARRA, EN LA LOC. DE CHILPANCINGO, MUNICIPIO DE CHILPANCINGO DE LOS BRAVO GRO. REHABILITACION DE DRENAJE SANITARIO EN LA BARRANCA APATZINGO, EN LA CALLE AMP. RAYUNGO, ABARCA ALARCON, EN LA LOC. DE CHILPANCINGO, MUNICIPIO DE CHILPANCINGO DE LOS BRAVO GRO. CONSTRUCCION DE RED DE DRENAJE SANITARIO EN LAS CALLES LAS ORQUIDEAS Y LOS BUCALITOS DE LA COLONIA SAN LUCAS, EN LA LOC. DE CHILPANCINGO, MUNICIPIO DE CHILPANCINGO DE LOS BRAVO GRO. REHABILITACION DE DRENAJE SANITARIO EN LA CALLE AV. DEL PORVENIR TRAMO: CALLE LA GIMA-CALLE CEDROS, DE LA COLONIA LOMAS DEL FONIENTE, EN LA LOC. DE CHILPANCINGO, MUNICIPIO DE CHILPANCINGO DE LOS BRAVO GRO. REHABILITACION DE RED DE DRENAJE SANITARIO Y REHABILITACION DE CALLE CON CONCRETO HIDRAULICO EN LA CALLE LIBERTAD DEL BARRIO DE SAN FRANCISCO, EN LA LOC. DE CHILPANCINGO, MUNICIPIO DE CHILPANCINGO DE LOS BRAVO GRO. AMPLIACION DE LA RED DE DISTRIBUCION DE AGUA POTABLE Y CONSTRUCCION DE CALLE CON CONCRETO HIDRAULICO EN EL ANDADOR ROBLE DE LA COLONIA RIVIERA, EN LA LOC. DE CHILPANCINGO, MUNICIPIO DE CHILPANCINGO DE LOS BRAVO GRO. CONSTRUCCION DE RED DE DRENAJE SANITARIO EN LA CALLE LAS AZUCENAS DE LA COLONIA SAN LUCAS, EN LA LOC. DE CHILPANCINGO, MUNICIPIO DE CHILPANCINGO DE LOS BRAVO GRO. AMPLIACION DE LA RED DE DRENAJE SANITARIO AL KM 0+615 DE LA COLONIA 10 DE JUNIO, EN LA LOC. DE PETAGUILLAS, MUNICIPIO DE CHILPANCINGO DE LOS BRAVO GRO. REHABILITACION DE LA PLANTA DE TRATAMIENTO DE AGUAS RESIDUALES DE 250 LPS, EN LA LOC. DE CHILPANCINGO, MUNICIPIO DE CHILPANCINGO DE LOS BRAVO GRO.	0.00	0.00	998,739.51	998,739.51	998,739.51	0.00
12353022002026002048		0.00	701,038.32	701,038.32	701,038.32	0.00	
12353022002026002049		0.00	419,202.24	419,202.24	419,202.24	0.00	
12353022002026002050		0.00	112,550.15	112,550.15	112,550.15	0.00	
12353022002026002051		0.00	860,693.49	860,693.49	860,693.49	0.00	
12353022002026002052		0.00	660,401.68	660,401.68	660,401.68	0.00	
12353022002026002053		0.00	270,363.41	270,363.41	270,363.41	0.00	
12353022002026002054		0.00	413,386.10	413,386.10	413,386.10	0.00	
12353022002026002055		0.00	2,000,000.00	2,000,000.00	2,000,000.00	0.00	

Handwritten signature and stamp of the Secretary of Finance and Administration.



M. Ayuntamiento Municipal Chilpancingo, Gro. CONTRALORIA INTERNA MUNICIPAL



H. AYUNTAMIENTO MUNICIPAL DE CHILPANCINGO, GRO.

SECRETARIA DE FINANZAS Y ADMINISTRACION

CONSOLIDADO



BALANZA DE COMPROBACION DEL 1 DE ENERO AL 31 DE DICIEMBRE DEL 2019

C U E N T A	C O N C E P T O	SALDOS INICIALES		M O V I M I E N T O S		SALDOS ACUMULADOS	
		AL 1 DE ENERO DE 2019		ENERO - DICIEMBRE 2019		AL 31 DE DICIEMBRE DE 2019	
		DEBE	HABER	DEBE	HABER	DEBE	HABER
12353022002026002066	CONSTRUCCION DE LA LINEA DE ALIMENTACION DE TRIBUNA NACIONAL A LOMA ALEGRE EN 12ª PONIENTE (ZINNIA) DE LA LOC. DE CHILPANCINGO, MUNICIPIO DE CHILPANCINGO DE LOS BRAVO GRO. SUMINISTRO E INSTALACION DE EQUIPOS PARA LOGRAR LA EFICIENCIA ELECTROMECANICA EN CARCAMOS Y ESTACIONES DE BOMBEO (DE TANQUE PRADERA A TANQUE CANTERA, DE TANQUE CANTERA A TANQUE PEÑA RAJADA, DE TANQUE VIGURI A TANQUE INDECO, DE TANQUE TOMATAL A TANQUE 21 DE MARZO, DE TANQUE HIDALGO A TANQUE LINDAVISTA, DE TANQUE TOMATAL A TANQUE SAN MATEO, DE TANQUE SAN MATEO A TANQUE ALTAMIRANO, DE TANQUE SAN MATEO A TANQUE LOMAS DE GUADALUPE Y DE TANQUE COLINAS A JAVIER MINA) EN LA LOC. DE CHILPANCINGO, MUNICIPIO DE CHILPANCINGO DE LOS BRAVO GRO. REHABILITACION DE LINEA DE CONDUCCION DE BARRANCA EL TULE PARA ABASTECER 5 COMUNIAS DE LA ZONA PONIENTE EN LA LOC. DE CHILPANCINGO, MUNICIPIO DE CHILPANCINGO DE LOS BRAVO GRO.	0.00		4,000,000.00		4,000,000.00	0.00
12353022002026002081	CONSTRUCCION DE TANQUE DE ALMACENAMIENTO DE AGUA DE 200 M3 DE CAPACIDAD Y LINEA DE CONDUCCION DE AGUA POTABLE EN LA LOC. DE MAZATLAN, MUNICIPIO DE CHILPANCINGO DE LOS BRAVO GRO. REHABILITACION DE DRENAJE SANITARIO EN LA AV. VICENTE GUERRERO SENTIDO SUR-NORTE, TRAMO: CALLE AYUTLA-CALLE ENCINO EN LA COLONIA PROGRESO, DE LA LOC. DE CHILPANCINGO, MUNICIPIO DE CHILPANCINGO DE LOS BRAVO GRO.	0.00		7,640,000.00		7,640,000.00	0.00
12353022002026002082	REHABILITACION Y PUESTA EN MARCHA DEL TANQUE DE ALMACENAMIENTO DE AGUA POTABLE DE LA COLONIA SATELITE EN LA LOC. DE CHILPANCINGO, MUNICIPIO DE CHILPANCINGO DE LOS BRAVO GRO. CONSTRUCCION DE DRENAJE SANITARIO EN LA CALLE LA LLUNA DE LA COLONIA LAS ESTRELLAS, DE LA LOC. DE CHILPANCINGO, MUNICIPIO DE CHILPANCINGO DE LOS BRAVO GRO. REHABILITACION DE DRENAJE SANITARIO Y CONSTRUCCION DE PAVIMENTO CON CONCRETO HIDRAULICO, EN LA CALLE SIMON BOLIVAR DE LA COLONIA GUERRERO, DE LA LOC. DE CHILPANCINGO, MUNICIPIO DE CHILPANCINGO DE LOS BRAVO GRO.	0.00		1,100,000.00		1,100,000.00	0.00
12353022002026002066	CONSTRUCCION DE TANQUE DE ALMACENAMIENTO DE AGUA DE 200 M3 DE CAPACIDAD Y LINEA DE CONDUCCION DE AGUA POTABLE EN LA LOC. DE MAZATLAN, MUNICIPIO DE CHILPANCINGO DE LOS BRAVO GRO. REHABILITACION DE DRENAJE SANITARIO EN LA AV. VICENTE GUERRERO SENTIDO SUR-NORTE, TRAMO: CALLE AYUTLA-CALLE ENCINO EN LA COLONIA PROGRESO, DE LA LOC. DE CHILPANCINGO, MUNICIPIO DE CHILPANCINGO DE LOS BRAVO GRO.	0.00		260,390.56		260,390.56	0.00
12353022002026002066	CONSTRUCCION DE TANQUE DE ALMACENAMIENTO DE AGUA DE 200 M3 DE CAPACIDAD Y LINEA DE CONDUCCION DE AGUA POTABLE EN LA LOC. DE MAZATLAN, MUNICIPIO DE CHILPANCINGO DE LOS BRAVO GRO. REHABILITACION DE DRENAJE SANITARIO EN LA AV. VICENTE GUERRERO SENTIDO SUR-NORTE, TRAMO: CALLE AYUTLA-CALLE ENCINO EN LA COLONIA PROGRESO, DE LA LOC. DE CHILPANCINGO, MUNICIPIO DE CHILPANCINGO DE LOS BRAVO GRO.	0.00		236,316.56		236,316.56	0.00
12353022002026002066	CONSTRUCCION DE TANQUE DE ALMACENAMIENTO DE AGUA DE 200 M3 DE CAPACIDAD Y LINEA DE CONDUCCION DE AGUA POTABLE EN LA LOC. DE MAZATLAN, MUNICIPIO DE CHILPANCINGO DE LOS BRAVO GRO. REHABILITACION DE DRENAJE SANITARIO EN LA AV. VICENTE GUERRERO SENTIDO SUR-NORTE, TRAMO: CALLE AYUTLA-CALLE ENCINO EN LA COLONIA PROGRESO, DE LA LOC. DE CHILPANCINGO, MUNICIPIO DE CHILPANCINGO DE LOS BRAVO GRO.	0.00		999,350.36		999,350.36	0.00
12353022002026002066	CONSTRUCCION DE TANQUE DE ALMACENAMIENTO DE AGUA DE 200 M3 DE CAPACIDAD Y LINEA DE CONDUCCION DE AGUA POTABLE EN LA LOC. DE MAZATLAN, MUNICIPIO DE CHILPANCINGO DE LOS BRAVO GRO. REHABILITACION DE DRENAJE SANITARIO EN LA AV. VICENTE GUERRERO SENTIDO SUR-NORTE, TRAMO: CALLE AYUTLA-CALLE ENCINO EN LA COLONIA PROGRESO, DE LA LOC. DE CHILPANCINGO, MUNICIPIO DE CHILPANCINGO DE LOS BRAVO GRO.	0.00		1,086,896.08		1,086,896.08	0.00
12353022002026002066	CONSTRUCCION DE TANQUE DE ALMACENAMIENTO DE AGUA DE 200 M3 DE CAPACIDAD Y LINEA DE CONDUCCION DE AGUA POTABLE EN LA LOC. DE MAZATLAN, MUNICIPIO DE CHILPANCINGO DE LOS BRAVO GRO. REHABILITACION DE DRENAJE SANITARIO EN LA AV. VICENTE GUERRERO SENTIDO SUR-NORTE, TRAMO: CALLE AYUTLA-CALLE ENCINO EN LA COLONIA PROGRESO, DE LA LOC. DE CHILPANCINGO, MUNICIPIO DE CHILPANCINGO DE LOS BRAVO GRO.	0.00		379,521.17		379,521.17	0.00

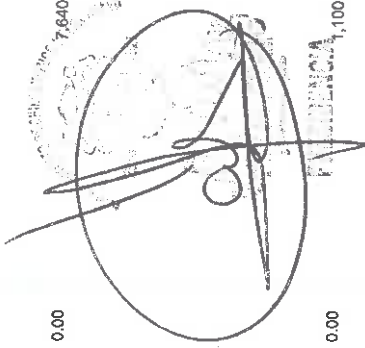

H. Ayuntamiento Municipal Constitucional de Chilpancingo, Gro. Contraloría Interna Municipal





H. AYUNTAMIENTO MUNICIPAL DE CHILPANCINGO, GRO.

SECRETARIA DE FINANZAS Y ADMINISTRACION

CONSOLIDADO



BALANZA DE COMPROBACION DEL 1 DE ENERO AL 31 DE DICIEMBRE DEL 2019

C U E N T A	C O N C E P T O	SALDOS INICIALES		MOVIMIENTOS		SALDOS ACUMULADOS	
		AL 1 DE ENERO DE 2019		ENERO - DICIEMBRE 2019		AL 31 DE DICIEMBRE DE 2019	
		DEBE	HABER	DEBE	HABER	DEBE	HABER
12353022002026002075	CANALIZACION DE AGUAS PLUVIALES EN EL JARDIN DE NIÑOS MARGARITA MAZA DE JUAREZ DE LA COLONIA ELECTRICISTAS, DE LA LOC. DE CHILPANCINGO, MUNICIPIO DE CHILPANCINGO DE LOS BRAVO GRO.	0.00		82,988.87		82,988.87	0.00
12353022002026002079	CONSTRUCCION DE RED DE ALCANTARILLADO SANITARIO EN LA CALLE VALERIO TRUJANO DE LA COLONIA GUERRERO 200, DE LA LOC. DE CHILPANCINGO, MUNICIPIO DE CHILPANCINGO DE LOS BRAVO GRO.	0.00		478,242.16		478,242.16	0.00
12353022002026002081	REHABILITACION DE RED DE DRENAJE SANITARIO EN LAS CALLES PUENTE STERLING-TABASCO-22 DE FEBRERO Y VICEPRESIDENTE, DE LA COLONIA JOSE MARIA PINO SUAREZ, EN LA LOC. DE CHILPANCINGO, MUNICIPIO DE CHILPANCINGO DE LOS BRAVO GRO.	0.00		733,724.05		733,724.05	0.00
12353022002026002083	CONSTRUCCION DE DRENAJE PLUVIAL EN LA AV. GOBERNADORES ENTRE CALLE BENITO JUAREZ Y CALLE PRIVADA DE LOS PINOS, EN LA LOC. DE CHILPANCINGO, MUNICIPIO DE CHILPANCINGO DE LOS BRAVO GRO.	0.00		207,703.48		207,703.48	0.00
12353022002026002084	CONSTRUCCION DE DRENAJE SANITARIO EN LA CALLE LA CIMA, EN LA COLONIA LOMAS DEL PORVENIR, EN LA LOC. DE CHILPANCINGO, MUNICIPIO DE CHILPANCINGO DE LOS BRAVO GRO.	0.00		700,394.72		700,394.72	0.00
12353022002026002087	REHABILITACION DE DRENAJE SANITARIO EN LA CALLE REVOLUCION DEL SUR, TRAMO: AV. VICENTE GUERRERO-CALLE 13 DE SEPTIEMBRE, EN LA COLONIA MORELOS, EN LA LOC. DE CHILPANCINGO, MUNICIPIO DE CHILPANCINGO DE LOS BRAVO GRO.	0.00		468,919.78		468,919.78	0.00
12353022002026002088	CONSTRUCCION DE RED DE AGUA POTABLE EN LAS CALLES 5 DE FEBRERO Y ENCINO, EN LA COLONIA 13 DE JUNIO, EN LA LOC. DE CHILPANCINGO, MUNICIPIO DE CHILPANCINGO DE LOS BRAVO GRO.	0.00		531,076.99		531,076.99	0.00
12353022002026002087	REHABILITACION DE LINEA DE AGUA POTABLE PARA LA CALLE ENSENADA DEL KM 0+000 AL KM 0+090, EN LA COLONIA MIRADOR, EN LA LOC. DE CHILPANCINGO, MUNICIPIO DE CHILPANCINGO DE LOS BRAVO GRO.	0.00		100,252.05		100,252.05	0.00
12353022002026002088	CONSTRUCCION DE RED DE DRENAJE SANITARIO EN LA CALLE LAZARO CARDENAS, DE LA COLONIA TIERRA Y LIBERTAD, EN LA LOC. DE CHILPANCINGO, MUNICIPIO DE CHILPANCINGO DE LOS BRAVO GRO.	0.00		451,616.19		451,616.19	0.00
12353022002026002089	CONSTRUCCION DE RED DE DRENAJE SANITARIO EN LA CALLE ESMERALDA, DE LA COLONIA VILLAS TLALMECAC, EN LA LOC. DE CHILPANCINGO, MUNICIPIO DE CHILPANCINGO DE LOS BRAVO GRO.	0.00		353,470.19		353,470.19	0.00

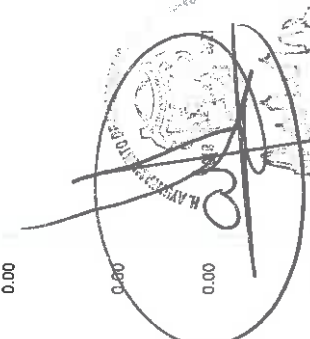
  
 H. AYUNTAMIENTO MUNICIPAL DE CHILPANCINGO, GRO.  
 SECRETARIA DE FINANZAS Y ADMINISTRACION

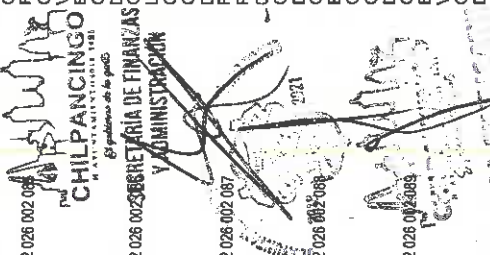
  
 H. AYUNTAMIENTO MUNICIPAL DE CHILPANCINGO, GRO.  
 SECRETARIA DE FINANZAS Y ADMINISTRACION



H. AYUNTAMIENTO MUNICIPAL DE CHILPANCINGO, GRO.

SECRETARIA DE FINANZAS Y ADMINISTRACION

CONSOLIDADO



BALANZA DE COMPROBACION DEL 1 DE ENERO AL 31 DE DICIEMBRE DEL 2019

C U E N T A	C O N C E P T O	SALDOS INICIALES		M O V I M I E N T O S		SALDOS ACUMULADOS	
		AL 1 DE ENERO DE 2019		ENERO - DICIEMBRE 2019		AL 31 DE DICIEMBRE DE 2019	
		DEBE	HABER	DEBE	HABER	DEBE	HABER
12353022002026002080	CONSTRUCCION DE RED DE DRENAJE SANITARIO EN EL ANTIGUO CAMINO A TIXTLA, DE LA COLONIA LA ESPERANZA, EN LA LOC. DE CHILPANCINGO, MUNICIPIO DE CHILPANCINGO DE LOS BRAVO, GRO.	0.00		414,044.11	414,044.11	0.00	0.00
12353022002026002081	MEJORAMIENTO EN LA RED DE DRENAJE SANITARIO Y CALLE EN EL ESPACIO PUBLICO DE LAS INSTALACIONES DE LA FERIA DE NAVIDAD Y AÑO NUEVO, EN LA LOC. DE CHILPANCINGO, MUNICIPIO DE CHILPANCINGO DE LOS BRAVO, GRO.	0.00		668,266.44	668,266.44	0.00	0.00
12353022002026002082	CONSTRUCCION DE LINEA DE DRENAJE SANITARIO EN LOS ANDADORES: MARGARITAS, ORQUIDEAS, ALCATRAZ Y JAZMIN, DE LA COLONIA PRIMAVERA, EN LA LOC. DE CHILPANCINGO, MUNICIPIO DE CHILPANCINGO DE LOS BRAVO, GRO.	0.00		587,574.09	587,574.09	0.00	0.00
12353022002026002083	CONSTRUCCION DE ALICANTARILLADO EN LA COLONIA FLORIDA, EN LA LOC. DE CHILPANCINGO, MUNICIPIO DE CHILPANCINGO DE LOS BRAVO, GRO.	0.00		678,844.96	678,844.96	0.00	0.00
12353022002026002084	REHABILITACION DE LA RED DE DRENAJE SANITARIO EN LA CALLE VIOLETA, DE LA COLONIA VILLA DE LAS FLORES, EN LA LOC. DE CHILPANCINGO, MUNICIPIO DE CHILPANCINGO DE LOS BRAVO, GRO.	0.00		405,707.02	405,707.02	0.00	0.00
12353022002026002085	CONSTRUCCION DE DRENAJE SANITARIO EN LA CALLE AGUA MARINA, DE LA COLONIA PALUDISMO, EN LA LOC. DE CHILPANCINGO, MUNICIPIO DE CHILPANCINGO DE LOS BRAVO, GRO.	0.00		398,145.49	398,145.49	0.00	0.00
12353022002026002086	REHABILITACION DE RED DE ALCANTARILLADO SANITARIO Y AGUA POTABLE EN LA CALLE LOS FRESNOS, DE LA COLONIA EL ENCANTO, EN LA LOC. DE CHILPANCINGO, MUNICIPIO DE CHILPANCINGO DE LOS BRAVO, GRO.	0.00		145,206.03	145,206.03	0.00	0.00
12353022002026002087	AMPLIACION DE RED DE DRENAJE SANITARIO EN LA CALLE MAURILLO FLORES, DE LA COLONIA LA TRINCHERA, EN LA LOC. DE CHILPANCINGO, MUNICIPIO DE CHILPANCINGO DE LOS BRAVO, GRO.	0.00		465,915.96	465,915.96	0.00	0.00
12353022002026002088	AMPLIACION Y PUESTA EN MARCHA DE LA LINEA DE DISTRIBUCION DE AGUA POTABLE EN LA LOC. DE ZOYATEPEC, MUNICIPIO DE CHILPANCINGO DE LOS BRAVO, GRO.	0.00		74,233.32	74,233.32	0.00	0.00
12353023	FONDO DE APORTAMIENTO PARA EL FORTALECIMIENTO MUNICIPAL	0.00		1,213,894.00	1,213,894.00	0.00	0.00
12353023002	CONTRATO	0.00		1,213,894.00	1,213,894.00	0.00	0.00
12353023002026	CONTRATO	0.00		1,213,894.00	1,213,894.00	0.00	0.00
12353023002026002	CONTRATO	0.00		1,213,894.00	1,213,894.00	0.00	0.00

Handwritten signature and stamp of the Secretary of Finance and Administration, dated 2019.

Official stamp of the Ayuntamiento Municipal Chilpancingo, Gro., with the text 'COPIA INTERNA MUNICIPALIDAD'.



H. AYUNTAMIENTO MUNICIPAL DE CHILPANCINGO, GRO.

SECRETARIA DE FINANZAS Y ADMINISTRACION

CONSOLIDADO



BALANZA DE COMPROBACIÓN DEL 1 DE ENERO AL 31 DE DICIEMBRE DEL 2019

C U E N T A	C O N C E P T O	SALDOS INICIALES		MOVIMIENTOS		SALDOS ACUMULADOS	
		AL 1 DE ENERO DE 2019		ENERO - DICIEMBRE 2019		AL 31 DE DICIEMBRE DE 2019	
		DEBE	HABER	DEBE	HABER	DEBE	HABER
1235302302026002001	REHABILITACION DEL EQUIPAMIENTO ELECTROMECANICO DEL POZO PROFUNDO T1 DEL SISTEMA DE AGUA POTABLE MOCHITLAN. REHABILITACION DE BOMBA SUMERGIBLE PARA UN GASTO DE 35 LPS Y UNA CARGA DINAMICA DE 190 MTS CON DESCARGA DE 6" DE DIAMETRO. ACOPLADA A MOTOR ELECTRICO SUMERGIBLE TRIFASICO DE 125 HP PARA OPERAR A 460 VOLTS 60 HZ MUNICIPIO DE CHILPANCINGO DE LOS BRAVO GUERRERO	0.00		1,213,894.00	1,213,894.00	0.00	0.00
12353032	PROGRAMA "PRODDER						
12353032002	AGUA Y SANEAMIENTO						
12353032002026	EJERCICIO 2019						
12353032002026002	EJERCICIO 2019						
12353032002026002001	REHABILITACION DEL EQUIPAMIENTO ELECTROMECANICO DEL POZO PROFUNDO M1 DEL SISTEMA DE AGUA POTABLE MOCHITLAN. REHABILITACION DE BOMBA SUMERGIBLE PARA UN GASTO DE 45 LPS Y UNA CARGA DINAMICA TOTAL DE 120 MTS CON DESCARGA DE 8" DE DIAMETRO, ACOPLADA A MOTOR ELECTRICO SUMERGIBLE, TRIFASICO DE 125 HP PARA OPERAR A 460 VOLTS Y 60 HZ. SUMINISTRO DE TUBERIA DE COLUMNA EN ACERO DE 8" DE DIAMETRO CED. 40 CON COPLE A UNA PROFUNDIDAD DE 120 MTS. REHABILITACION DE LINEA DE CONDUCCION DEL SISTEMA DE AGUA POTABLE EL RETAJE. SUMINISTRO E INSTALACION DE TUBERIA EN ACERO DE 8" DE DIAMETRO CED. 40 COLOCACION DE ATRAGUES DE CONCRETO DE FC=250 KG/CM2 CADA 300 MTS. FABRICACION DE CAJAS DE VALVULAS EN EL MUNICIPIO DE CHILPANCINGO DE LOS BRAVO.	0.00		1,906,981.00	1,906,981.00	0.00	0.00
12353040	AGUA Y SANEAMIENTO						
12353040002	EJERCICIO 2019						
12353040002026	CONTRATO						
12353040002026002001	REHABILITACION DE BOMBA SUMERGIBLE PARA UN GASTO DE 45 LPS Y UNA CARGA DINAMICA TOTAL DE 120 MTS CON DESCARGA DE 8" DE DIAMETRO, ACOPLADA A MOTOR ELECTRICO SUMERGIBLE, TRIFASICO DE 125 HP PARA OPERAR A 460 VOLTS Y 60 HZ. SUMINISTRO DE TUBERIA DE COLUMNA EN ACERO DE 8" DE DIAMETRO CED. 40 CON COPLE A UNA PROFUNDIDAD DE 120 MTS.	0.00		692,511.17	692,511.17	0.00	0.00

1,906,981.00  
1,906,981.00  
1,906,981.00  
1,906,981.00  
656,981.00

1,250,000.00

692,511.17  
692,511.17  
692,511.17  
692,511.17  
692,511.17

2018  
2021

SECRETARIA DE FINANZAS Y ADMINISTRACION

SECRETARIA DE FINANZAS Y ADMINISTRACION



H. Ayuntamiento Municipal Constitucional de Chilpancingo, Gro.  
CONTRALORIA INTERNA MUNICIPAL



H. AYUNTAMIENTO MUNICIPAL DE CHILPANCINGO, GRO.

SECRETARIA DE FINANZAS Y ADMINISTRACION

CONSOLIDADO

BALANZA DE COMPROBACION DEL 1 DE ENERO AL 31 DE DICIEMBRE DEL 2019

C U E N T A	C O N C E P T O	SALDOS INICIALES		M O V I M I E N T O S		SALDOS ACUMULADOS	
		AL 1 DE ENERO DE 2019		ENERO - DICIEMBRE 2019		AL 31 DE DICIEMBRE DE 2019	
		DEBE	HABER	DEBE	HABER	DEBE	HABER
12354	DIVISION DE TERRENOS Y CONSTRUCCION DE OBRAS DE URBANIZACION EN PROCESO	541,080.73		94,851,207.04	94,851,207.04	541,080.73	
12354021	GASTO CORRIENTE	541,080.73		0.00	0.00	541,080.73	
12354021025	EJERCICIO 2018 (NVA ADMON 2018-2021)	541,080.73		0.00	0.00	541,080.73	
12354021025004	OBRA DE LA COPARTICIPACION AL FORTASEG	541,080.73		0.00	0.00	541,080.73	
12354021025004001	REMODELACION Y ACONDICIONAMIENTO EN EL AREA DE ARMERIA DE LA COMANDANCIA DE SEGURIDAD PUBLICA, (ADQUISICION DE LOCKERS)	178,053.78		0.00	0.00	178,053.78	
12354021025004002	REMODELACION Y ACONDICIONAMIENTO EN EL AREA DE ARMERIA DE LA COMANDANCIA DE SEGURIDAD PUBLICA, (OBRA PUBLICA)	65,000.00		0.00	0.00	65,000.00	
12354021025004003	REMODELACION Y AMPLIACION DE LAS INSTALACIONES DE LAS BASES DE DATOS CRIMINALISTICA Y DE PERSONAL DE SEGURIDAD PUBLICA.	187,268.08		0.00	0.00	187,268.08	
12354021025004004	EQUIPAMIENTO DEL C-3 DE LA SECRETARIA DE SEGURIDAD PUBLICA.	110,768.87		0.00	0.00	110,768.87	
12354022	FONDO PARA LA INFRAESTRUCTURA SOCIAL MUNICIPAL	0.00		86,147,012.55	86,147,012.55	0.00	
12354022001	URBANIZACION	0.00		85,741,337.79	85,741,337.79	0.00	
12354022001026	EJERCICIO 2019	0.00		85,741,337.79	85,741,337.79	0.00	
12354022001026002	CONTRATO	0.00		1,250,369.39	1,250,369.39	0.00	
12354022001026002002	CONSTRUCCION DE PUENTE VEHICULAR UN CARRIL EN LA LOCALIDAD DE PALO BLANCO ESTADO DE GUERRERO.	0.00		360,373.57	360,373.57	0.00	
12354022001026002002002	REHABILITACION CON CONCRETO HIDRAULICO DE LA AV. RUFFO FIGUEROA Y AV. LAZARO CARDENAS, DE LA COL. BUROCRATAS, DE CHILPANCINGO DE LOS BRAVO, ESTADO DE GUERRERO.	0.00		0.00	0.00	0.00	
12354022001026002002003	RASTREO DE CAMINO RURAL : CRUGERO COL LA CINCA - NUEVA MIRADOR, DE CHILPANCINGO DE LOS BRAVO, ESTADO DE GUERRERO	0.00		138,163.52	138,163.52	0.00	
12354022001026002002004	PAVIMENTACION DE LA AV. VICENTE GUERRERO, ENTRE PUENTE PEATONAL-CALLE GABRIEL LEIVA, COLONIA DEL PRI DE LA CIUDAD DE CHILPANCINGO DE LOS BRAVO GUERRERO	0.00		1,321,362.18	1,321,362.18	0.00	
12354022001026002005	CONSTRUCCION DE MURO DE CONTENCIÓN EN LA COL. SAN JOSE, DE CHILPANCINGO DE LOS BRAVO, GUERRERO.	0.00		981,056.64	981,056.64	0.00	
12354022001026002006	REHABILITACION DEL PAVIMENTO CON MEZCLA ASFALTICA EN CALIENTE DE LAS CALLES ANTONIA NAVA DE CATALAN DEL BARRIO DE SAN FRANCISCO, JUAN N. ALVAREZ DE LA COL. CENTRO Y DE LAS CALLES GONZALO N. RAMIREZ, CONSTITUCION POLITICA Y AVENIDA DEL SOL, DE LAS COL. TRIBUNA NACIONAL Y HACIENDA II, DE CHILPANCINGO DE LOS BRAVO, ESTADO DE	0.00		1,066,568.09	1,066,568.09	0.00	

*[Handwritten signature and stamp]*



H. Ayuntamiento Municipal Chilpancingo  
SECRETARIA DE FINANZAS Y ADMINISTRACION



H. AYUNTAMIENTO MUNICIPAL DE CHILPANCINGO, GRO.

SECRETARIA DE FINANZAS Y ADMINISTRACION

CONSOLIDADO



BALANZA DE COMPROBACIÓN DEL 1 DE ENERO AL 31 DE DICIEMBRE DEL 2019

C U E N T A	C O N C E P T O	SALDOS INICIALES		M O V I M I E N T O S		SALDOS ACUMULADOS	
		AL 1 DE ENERO DE 2019		ENERO - DICIEMBRE 2019		AL 31 DE DICIEMBRE DE 2019	
		DEBE	HABER	DEBE	HABER	DEBE	HABER
12354022001026002007	GUERRERO. REHABILITACION CON MEZCLA ASFALTICA EN CALIENTE, EN CARRILES LATERALES DEL BOULEVARD VICENTE GUERRERO, ENTRE LAS CALLES 1RA DE LA COL. DEL PRI Y CENTRO ESCOLAR VICENTE GUERRERO, DE CHILPANCINGO DE LOS BRAVO, ESTADO DE GUERRERO.	0.00		1,337,223.58	1,337,223.58	0.00	0.00
12354022001026002008	REHABILITACION CON MEZCLA ASFALTICA DEL ACCESO PRINCIPAL DE LA LOCALIDAD DE ACAHUIZOTLA, MPIO. DE CHILPANCINGO DE LOS BRAVO, ESTADO DE GUERRERO.	0.00		663,694.07	663,694.07	0.00	0.00
12354022001026002009	CONSTRUCCION DE ALBERGUE EN LA COMUNIDAD DE SAN MIGUEL, MPIO. DE CHILPANCINGO DE LOS BRAVO, ESTADO DE GUERRERO.	0.00		955,162.34	955,162.34	0.00	0.00
12354022001026002010	CONSTRUCCION DE ALEROS PARA ACCESOS DE ENTRADA Y SALIDA DEL PUENTE VEHICULAR EL ASERRADERO, EN LA LOCALIDAD DE JALEACA DE CATALAN MUNICIPIO DE CHILPANCINGO DE LOS BRAVO, ESTADO DE GUERRERO.	0.00		1,478,517.82	1,478,517.82	0.00	0.00
12354022001026002011	RASTREO DE CAMINO RURAL: CRUCERO PIEDRA LUJA - LA ESPERANZA EN EL MUNICIPIO DE CHILPANCINGO DE LOS BRAVO, EN EL ESTADO DE GUERRERO.	0.00		500,000.00	500,000.00	0.00	0.00
12354022001026002012	RASTREO DE CAMINO RURAL: AZINYAHUALCO - ZOYATEPEC EN EL MUNICIPIO DE CHILPANCINGO DE LOS BRAVO, EN EL ESTADO DE GUERRERO	0.00		400,000.00	400,000.00	0.00	0.00
12354022001026002013	PAVIMENTACION DE DIVERSAS CALLES EN EL MUNICIPIO DE CHILPANCINGO	0.00		1,364,077.85	1,364,077.85	0.00	0.00
12354022001026002014	CONSTRUCCION DE LOS ACCESOS AL PUENTE VEHICULAR UN CARRIL EN LA LOC. DE PALO BLANCO, MPIO DE CHILPANCINGO DE LOS BRAVO, ESTADO DE GUERRERO	0.00		1,595,284.36	1,595,284.36	0.00	0.00
12354022001026002015	PAVIMENTACION CON CONCRETO HIDRAULICO DE LA CALLE VICENTE LOMBARDO TOLEDANO Y ALTAMIRANO EN LAS COL. COOPERATIVA DE VIVIENDA Y MARGARITA VIGURI, LOC. DE CHILPANCINGO, MUNICIPIO DE CHILPANCINGO DE LOS BRAVO GRO. (CONVENIO CICAEG)	0.00		2,373,546.74	2,373,546.74	0.00	0.00
12354022001026002016	PAVIMENTACION CON CONCRETO HIDRAULICO DEL ACCESO A LA COLONIA CNOP SECCION B, CALLE MIRADOR TRAMO: CALLE ATALAYA-CALLE FERNANDO LOPEZ, LOC. DE CHILPANCINGO MUNICIPIO DE CHILPANCINGO DE LOS BRAVO GRO. (CONVENIO CICAEG)	0.00		759,475.89	759,475.89	0.00	0.00
12354022001026002017	PAVIMENTACION CON CONCRETO HIDRAULICO DE LA CALLE MARISCAL GALEANA COL. HERMENEGILDO GALEANA, LOC DE CHILPANCINGO, MUNICIPIO DE CHILPANCINGO DE LOS BRAVO GRO. (CONVENIO CICAEG)	0.00		1,793,559.63	1,793,559.63	0.00	0.00
12354022001026002018	PAVIMENTACION CON CONCRETO HIDRAULICO TRAMO LATERAL DE LA AV. INSURGENTES, CALLE	0.00		891,731.08	891,731.08	0.00	0.00

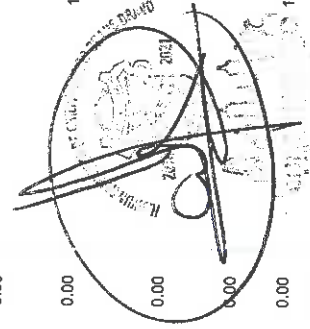

SECRETARIA DE FINANZAS Y ADMINISTRACION  
MAYOR CUENTA DE CONSOLIDACION DE  
Cuentas de la SECRETARIA MUNICIPAL DE  
CHILPANCINGO, GRO.





H. AYUNTAMIENTO MUNICIPAL DE CHILPANCINGO, GRO.

SECRETARIA DE FINANZAS Y ADMINISTRACION

CONSOLIDADO



BALANZA DE COMPROBACIÓN DEL 1 DE ENERO AL 31 DE DICIEMBRE DEL 2019

C U E N T A	C O N C E P T O	SALDOS INICIALES		M O V I M I E N T O S		SALDOS ACUMULADOS	
		AL 1 DE ENERO DE 2019		ENERO - DICIEMBRE 2019		AL 31 DE DICIEMBRE DE 2019	
		DEBE	HABER	DEBE	HABER	DEBE	HABER
12354022001026002020	18 DE JULIO Y CALLE LUCIA ALCOCER COL. BENITO JUAREZ Y MORELOS, LOC. DE CHILPANCINGO. MUNICIPIO DE CHILPANCINGO GRO. (CONVENIO CICAEG) PAVIMENTACION CON CONCRETO HIDRAULICO DE LA CALLE CONSTRUCTORES TRAMO -AV. GOBERNADORES- ANDADOR 1, FRACC. PENSADORES, LOC DE CHILPANCINGO. MUNICIPIO DE CHILPANCINGO DE LOS BRAVO GRO. (CONVENIO CICAEG) PAVIMENTACION CON CONCRETO HIDRAULICO PRIMERA ETAPA DE LA CALLE TULIPANES COL. INDECO Y LOS SAUCES, LOC. DE CHILPANCINGO. MUNICIPIO DE CHILPANCINGO DE LOS BRAVO GRO. (CONVENIO CICAEG) PAVIMENTACION CON CONCRETO HIDRAULICO PRIMERA ETAPA DE LA CALLE PROSPERIDAD COL. UNIVERSAL, LOC. DE CHILPANCINGO. MUNICIPIO DE CHILPANCINGO DE LOS BRAVO GRO. (CONVENIO CICAEG) PAVIMENTACION CON CONCRETO HIDRAULICO DE LA CALLE REAL, TRAMO BARRANCA CHUCHUYULUYA LUIS DONALDO COLOSIO, COL. HERNANDESGILDO GALEANA, LOC. DE CHILPANCINGO. MUNICIPIO DE CHILPANCINGO DE LOS BRAVO GRO. (CONVENIO CICAEG) PAVIMENTACION CON CONCRETO HIDRAULICO DE LA CALLE ALTAMIRANO EN LA COL. MARGARITA FIGURI, LOC DE CHILPANCINGO. MUNICIPIO DE CHILPANCINGO DE LOS BRAVO. (CONVENIO CICAEG) CONSTRUCCION DE ACCESO A LAS COLONIAS AGUILAS Y MARTIRES ANTOCHISTA, LOC DE CHILPANCINGO. MUNICIPIO DE CHILPANCINGO DE LOS BRAVO. (CONVENIO CICAEG). CONSTRUCCION DE PAVIMENTO CON CONCRETO HIDRAULICO EN LA CALLE ROSARIO IBARRA, TRAMO: CALLE GENARO VAZQUEZ - CALLE AMALIA GARCIA MEDINA DE LA COLONIA PRD, LOC. DE CHILPANCINGO. MUNICIPIO DE CHILPANCINGO DE LOS BRAVO. CONSTRUCCION DE PAVIMENTO CON CONCRETO HIDRAULICO EN EL ANDADOR No.2, DE LA COLONIA SAN ANGEL, LOC. DE CHILPANCINGO. MUNICIPIO DE CHILPANCINGO DE LOS BRAVO. CONSTRUCCION DE MURO DE CONTENCIÓN EN LA BARRANCA EL HUIZACHAL EN LA CALLE CEIBAS, DE LA COLONIA HACIENDITA, LOC. DE CHILPANCINGO. MUNICIPIO DE CHILPANCINGO DE LOS BRAVO. CONSTRUCCION DE CANCHA DEPORTIVA EN LA LOC. DE RINCON DE ALCAPARROSA, MUNICIPIO DE CHILPANCINGO DE LOS BRAVO.	0.00	0.00	1,229,195.48	1,209,473.10	1,229,195.48	0.00
12354022001026002021		0.00	0.00	1,209,473.10	1,209,473.10	0.00	
12354022001026002022		0.00	0.00	1,135,492.97	1,135,492.97	0.00	
12354022001026002024		0.00	0.00	1,142,275.72	1,142,275.72	0.00	
12354022001026002024		0.00	0.00	2,002,508.86	2,002,508.86	0.00	
12354022001026002025		0.00	0.00	1,005,173.44	1,005,173.44	0.00	
12354022001026002026		0.00	0.00	1,376,405.97	1,376,405.97	0.00	
12354022001026002027		0.00	0.00	550,124.36	550,124.36	0.00	
12354022001026002028		0.00	0.00	293,822.79	293,822.79	0.00	
12354022001026002029		0.00	0.00	547,854.09	547,854.09	0.00	

H. AYUNTAMIENTO MUNICIPAL DE CHILPANCINGO, GRO.  
 SECRETARIA DE FINANZAS Y ADMINISTRACION  
 2019



Contralor Interna Municipal  
 Contralor Interna Municipal



H. AYUNTAMIENTO MUNICIPAL DE CHILPANCINGO, GRO.

SECRETARIA DE FINANZAS Y ADMINISTRACION

CONSOLIDADO



BALANZA DE COMPROBACION DEL 1 DE ENERO AL 31 DE DICIEMBRE DEL 2019

C U E N T A	C O N C E P T O	SALDOS INICIALES		M O V I M I E N T O S		SALDOS ACUMULADOS	
		AL 1 DE ENERO DE 2019		ENERO - DICIEMBRE 2019		AL 31 DE DICIEMBRE DE 2019	
		DEBE	HABER	DEBE	HABER	DEBE	HABER
12354022001026002030	CONSTRUCCIÓN DE PAVIMENTO CON CONCRETO HIDRAULICO EN EL ANDADOR N° 2 DE LA COLONIA LA TRINCHERA, DE LA LOC. DE CHILPANCINGO, MUNICIPIO DE CHILPANCINGO DE LOS BRAVO.	0.00		986,322.12		986,322.12	0.00
12354022001026002031	CONSTRUCCIÓN DE PAVIMENTO CON CONCRETO HIDRAULICO EN EL ACCESO PRINCIPAL A LA COLONIA POTRERITO, TRAMO: KM 0+000 AL KM 0+124 DE LA LOC. DE CHILPANCINGO, MUNICIPIO DE CHILPANCINGO DE LOS BRAVO.	0.00		872,752.27		872,752.27	0.00
12354022001026002032	REHABILITACIÓN DE CAMINO RURAL: JALEACA DE CATALAN - LA CUMBRE TRAMO: KM 0+000 AL KM 1+500, MUNICIPIO DE CHILPANCINGO DE LOS BRAVO.	0.00		905,680.00		905,680.00	0.00
12354022001026002033	REHABILITACIÓN DE CAMINO RURAL: EL SALITRE - EL CIRUELAR TRAMO: KM 0+000 AL KM 20+000, MUNICIPIO DE CHILPANCINGO DE LOS BRAVO.	0.00		609,342.00		609,342.00	0.00
12354022001026002034	CONSTRUCCIÓN DE PAVIMENTO CON CONCRETO HIDRAULICO EN LA CALLE BUGAMBILIAS, TRAMO: KM 0+000 AL KM 0+085, EN LA COLONIA 20 DE MAYO EN LA LOC. DE PETAGUILLAS, MUNICIPIO DE CHILPANCINGO DE LOS BRAVO.	0.00		735,474.05		735,474.05	0.00
12354022001026002035	REHABILITACION DE PAVIMENTO CON MEZCLA ASFALTICA EN DIVERSAS CALLES DEL MUNICIPIO DE CHILPANCINGO DE LOS BRAVO.	0.00		341,702.87		341,702.87	0.00
12354022001026002036	REHABILITACION DE PAVIMENTO CON CONCRETO HIDRAULICO EN DIVERSAS CALLES DEL MUNICIPIO DE CHILPANCINGO DE LOS BRAVO.	0.00		254,161.34		254,161.34	0.00
12354022001026002037	CONSTRUCCION DE MURO DE CONTENCIÓN EN LA COLONIA LAS PALMAS, EN LA LOC. DE CHILPANCINGO, MUNICIPIO DE CHILPANCINGO DE LOS BRAVO.	0.00		1,317,780.06		1,317,780.06	0.00
12354022001026002038	CONSTRUCCION DE JALAHUATZINGO EN LA COLONIA GUERRERO, EN LA LOC. DE CHILPANCINGO, MUNICIPIO DE CHILPANCINGO DE LOS BRAVO.	0.00		84,264.81		84,264.81	0.00
12354022001026002039	CONSTRUCCION DE PAVIMENTO CON CONCRETO HIDRAULICO DE LA CALLE PROFESORA MA. ISABEL LEYVA MANCILLA EN EL FRACCIONAMIENTO VILLAS DE LEYVA, EN LA LOC. DE CHILPANCINGO, MUNICIPIO DE CHILPANCINGO DE LOS BRAVO.	0.00		707,324.63		707,324.63	0.00
12354022001026002041	MEJORAMIENTO DE CALLES CON REVESTIMIENTO EN LA CIUDAD DE CHILPANCINGO, MUNICIPIO DE CHILPANCINGO, MUNICIPIO DE CHILPANCINGO DE LOS BRAVO.	0.00		1,290,128.00		1,290,128.00	0.00
12354022001026002042	CONSTRUCCION DEL PAVIMENTO CON CONCRETO HIDRAULICO EN LA CALLE AV. ARQUITECTURA, TRAMO: CALLE RENE JUAREZ CISNEROS-CALLE INGENIERIA, DE LA COLONIA REFORMA UNIVERSITARIA, EN LA LOC. DE	0.00		863,336.93		863,336.93	0.00

Stamp: AYUNTAMIENTO MUNICIPAL DE CHILPANCINGO, GRO. SECRETARIA DE FINANZAS Y ADMINISTRACION. 2018. Includes a signature and a circular stamp.





H. AYUNTAMIENTO MUNICIPAL DE CHILPANCINGO, GRO.

SECRETARIA DE FINANZAS Y ADMINISTRACION

CONSOLIDADO



BALANZA DE COMPROBACIÓN DEL 1 DE ENERO AL 31 DE DICIEMBRE DEL 2019

C U E N T A	C O N C E P T O	SALDOS INICIALES		MOVIMIENTOS		SALDOS ACUMULADOS	
		AL 1 DE ENERO DE 2019		ENERO - DICIEMBRE 2019		AL 31 DE DICIEMBRE DE 2019	
		DEBE	HABER	DEBE	HABER	DEBE	HABER
12354022001026002043	CHILPANCINGO, MUNICIPIO DE CHILPANCINGO DE LOS BRAVO. CONSTRUCCION DEL PAVIMENTO CON CONCRETO HIDRAULICO EN LA CALLE JOSE MARIA MORELOS Y PAVON, DE LA COLONIA 16 DE SEPTIEMBRE, EN LA LOC. DE CHILPANCINGO, MUNICIPIO DE CHILPANCINGO DE LOS BRAVO.	0.00		938,610.69		938,610.69	0.00
12354022001026002044	CHILPANCINGO, MUNICIPIO DE CHILPANCINGO DE LOS BRAVO. CONCRETO HIDRAULICO EN LA CALLE PROF. ENRIQUE CABRERA TRAMO: ANDADOR PROF. LUCIO CABANAS BARRIENTOS-CALLE JANITZIO, EN LA COLONIA UNIDAD MAGISTERIAL, EN LA LOC. DE CHILPANCINGO, MUNICIPIO DE CHILPANCINGO DE LOS BRAVO.	0.00		695,662.15		695,662.15	0.00
12354022001026002045	CHILPANCINGO, MUNICIPIO DE CHILPANCINGO DE LOS BRAVO. REHABILITACION DEL PAVIMENTO CON CONCRETO HIDRAULICO EN LA CALLE ENSEÑADA TRAMO: KM 0+000 AL KM 0+090, EN LA COLONIA EL MIRADOR, EN LA LOC. DE CHILPANCINGO, MUNICIPIO DE CHILPANCINGO DE LOS BRAVO.	0.00		525,504.02		525,504.02	0.00
12354022001026002046	CHILPANCINGO, MUNICIPIO DE CHILPANCINGO DE LOS BRAVO. CONSTRUCCION DEL PAVIMENTO CON CONCRETO HIDRAULICO EN LA CALLE NINFA TRAMO: KM 0+000-CALLE PRIMERA, EN LA COLONIA VALLE DORADO, EN LA LOC. DE CHILPANCINGO, MUNICIPIO DE CHILPANCINGO DE LOS BRAVO.	0.00		969,523.01		969,523.01	0.00
12354022001026002047	CHILPANCINGO, MUNICIPIO DE CHILPANCINGO DE LOS BRAVO. CONSTRUCCION DEL PAVIMENTO CON CONCRETO HIDRAULICO EN LA CALLE FRANCISCO VILLA TRAMO: CALLE ENCINO-CALLE ALAMOS, DE LA COLONIA EMILIANO ZAPATA, EN LA LOC. DE CHILPANCINGO, MUNICIPIO DE CHILPANCINGO DE LOS BRAVO.	0.00		854,866.21		854,866.21	0.00
12354022001026002048	CHILPANCINGO, MUNICIPIO DE CHILPANCINGO DE LOS BRAVO. CONCRETO HIDRAULICO EN LA CALLE EMILIANO ZAPATA, DE LA COLONIA FRANCISCO VILLA, EN LA LOC. DE CHILPANCINGO, MUNICIPIO DE CHILPANCINGO DE LOS BRAVO.	0.00		1,075,662.30		1,075,662.30	0.00
12354022001026002049	CHILPANCINGO, MUNICIPIO DE CHILPANCINGO DE LOS BRAVO. CONCRETO HIDRAULICO EN LA CALLE JOSE MARIA MORELOS TRAMO: CALLE REVOLUCION-CALLE MEXICO, EN LA LOC. DE CHILPANCINGO, MUNICIPIO DE CHILPANCINGO DE LOS BRAVO.	0.00		384,199.89		384,199.89	0.00
12354022001026002050	CHILPANCINGO, MUNICIPIO DE CHILPANCINGO DE LOS BRAVO. CONSTRUCCION DE PAVIMENTO CON CONCRETO HIDRAULICO EN LA CALLE BENITO JUAREZ TRAMO: KM 0+000 AL KM 0+100, EN LA COLONIA MEXICO, EN LA LOC. DE CHILPANCINGO, MUNICIPIO DE CHILPANCINGO DE LOS BRAVO.	0.00		647,599.71		647,599.71	0.00
12354022001026002051	CHILPANCINGO, MUNICIPIO DE CHILPANCINGO DE LOS BRAVO. CONSTRUCCION DE PAVIMENTO CON CONCRETO HIDRAULICO EN LA CALLE DURANGO TRAMO: KM 0+000 AL KM 0+150, EN LA COLONIA TERRERO, EN LA LOC. DE CHILPANCINGO, MUNICIPIO DE CHILPANCINGO DE LOS BRAVO.	0.00		914,165.90		914,165.90	0.00



AYUNTAMIENTO MUNICIPAL DE CHILPANCINGO, GRO. SECRETARIA DE FINANZAS Y ADMINISTRACION



SECRETARIA DE FINANZAS Y ADMINISTRACION



H. AYUNTAMIENTO MUNICIPAL DE CHILPANCINGO, GRO.

SECRETARIA DE FINANZAS Y ADMINISTRACION

CONSOLIDADO



BALANZA DE COMPROBACION DEL 1 DE ENERO AL 31 DE DICIEMBRE DEL 2019

C U E N T A	C O N C E P T O	SALDOS INICIALES		M O V I M I E N T O S		SALDOS ACUMULADOS	
		AL 1 DE ENERO DE 2019		ENERO - DICIEMBRE 2019		AL 31 DE DICIEMBRE DE 2019	
		DEBE	HABER	DEBE	HABER	DEBE	HABER
12354022001026002052	CONSTRUCCION DE PAVIMENTO CON CONCRETO HIDRAULICO EN LA CALLE VICENTE GUERRERO TRAMO: KM 0+000 AL KM 0+060, EN LA COLONIA MIGUEL HIDALGO, EN LA LOC. DE CHILPANCINGO, MUNICIPIO DE CHILPANCINGO DE LOS BRAVO.	0.00		504,203.44	504,203.44	0.00	
12354022001026002053	CONSTRUCCION DE PAVIMENTO CON CONCRETO HIDRAULICO EN LA CALLE VICENTE GUERRERO, EN LA COLONIA INDEPENDENCIA, EN LA LOC. DE CHILPANCINGO, MUNICIPIO DE CHILPANCINGO DE LOS BRAVO.	0.00		281,141.45	281,141.45	0.00	
12354022001026002054	CONSTRUCCION DE PAVIMENTO CON CONCRETO HIDRAULICO EN LA CALLE CARITINO MALDONADO TRAMO: CALLE FELICIANO DOMINGUEZ-CALLE SEVERIANO RODRIGUEZ, EN LA COLONIA PLAN DE AYALA, EN LA LOC. DE CHILPANCINGO, MUNICIPIO DE CHILPANCINGO DE LOS BRAVO.	0.00		555,721.93	555,721.93	0.00	
12354022001026002055	CONSTRUCCION DE PAVIMENTO CON CONCRETO HIDRAULICO EN LA CALLE GONZALO ALARCON ADAME TRAMO: KM 0+156 AL KM 0+266, EN LA COLONIA IXQUIJAPA, EN LA LOC. DE CHILPANCINGO, MUNICIPIO DE CHILPANCINGO DE LOS BRAVO.	0.00		802,257.59	802,257.59	0.00	
12354022001026002056	REHABILITACION DE CAMINO RURAL: CRUCERO DEL MATADERO - HELIODORO CASTILLO (CHICAHUALES), MUNICIPIO DE CHILPANCINGO DE LOS BRAVO.	0.00		376,840.51	376,840.51	0.00	
12354022001026002057	REHABILITACION DE CAMINO RURAL: TRAMO: COAPANGO-EL FRESNO, MUNICIPIO DE CHILPANCINGO DE LOS BRAVO.	0.00		574,827.15	574,827.15	0.00	
12354022001026002058	CONSTRUCCION DE MURO DE CONTENCIÓN EN EL CIRCUITO BENITO JUAREZ, EN LA COLONIA AMPLIACION INDEPENDENCIA, EN LA LOC. DE CHILPANCINGO, MUNICIPIO DE CHILPANCINGO DE LOS BRAVO.	0.00		969,826.79	969,826.79	0.00	
12354022001026002059	REHABILITACION DEL PAVIMENTO CON MEZCLA ASFALTICA EN LA AVENIDA VICENTE GUERRERO, TRAMO: CALLE MOISES GUEVARA-CALLE 21 DE MARZO, DE LA COLONIA BENITO JUAREZ Y EN LA AVENIDA TOMA DE OAXACA TRAMO: AV. INSURGENTES-AV. VICENTE GUERRERO EN LA COLONIA HERMENEGILDO GALEANA, EN LA LOC. DE CHILPANCINGO, MUNICIPIO DE CHILPANCINGO DE LOS BRAVO.	0.00		695,262.48	695,262.48	0.00	
12354022001026002060	CONSTRUCCION DE PAVIMENTO CON CONCRETO HIDRAULICO DE LA CALLE GUERRERO, TRAMO: CALLE MADERO-CALLE JUAN N. ALVAREZ, EN LA LOC. DE MAZATLAN, MUNICIPIO DE CHILPANCINGO DE LOS BRAVO.	0.00		986,303.94	986,303.94	0.00	
12354022001026002061	CONSTRUCCION DE PAVIMENTO CON CONCRETO HIDRAULICO DE LA CALLE GABRIEL GARCIA MARQUEZ DE LA COLONIA RUBEN MORA, EN LA LOC. DE CHILPANCINGO, MUNICIPIO DE CHILPANCINGO DE LOS BRAVO.	0.00		827,123.50	827,123.50	0.00	

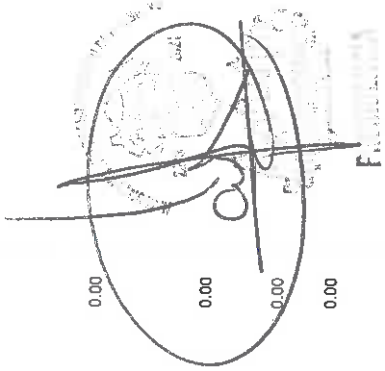

H. Ayuntamiento Municipal Constitucional de Chilpancingo, Gro. Ayuntamiento Municipal

6.08.08 PM

Coram/ Balanza

miércoles 25 marzo 2020





H. AYUNTAMIENTO MUNICIPAL DE CHILPANCINGO, GRO.  
SECRETARIA DE FINANZAS Y ADMINISTRACION

CONSOLIDADO



BALANZA DE COMPROBACION DEL 1 DE ENERO AL 31 DE DICIEMBRE DEL 2019

C U E N T A	C O N C E P T O	SALDOS INICIALES		M O V I E N T O S		SALDOS ACUMULADOS	
		AL 1 DE ENERO DE 2019		ENERO - DICIEMBRE 2019		AL 31 DE DICIEMBRE DE 2019	
		DEBE	HABER	DEBE	HABER	DEBE	HABER
12354022001026002062	CONSTRUCCION DE PAVIMENTO CON CONCRETO HIDRAULICO DE LA CALLE REVOLUCION DEL SUR, TRAMO: AV. VICENTE GUERRERO A LA CALLE 13 DE SEPTIEMBRE, EN LA COLONIA MORELOS, LOC. DE CHILPANCINGO, MUNICIPIO DE CHILPANCINGO DE LOS BRAVO.	0.00		1,491,640.13		1,491,640.13	0.00
12354022001026002063	CONSTRUCCION DE PAVIMENTO CON CONCRETO HIDRAULICO EN LA CALLE JACARANDAS, TRAMO: KM 0+000 AL KM 0+100, EN LA COLONIA ASOCIACION CIVIL D-IIJ2, LOC. DE CHILPANCINGO, MUNICIPIO DE CHILPANCINGO DE LOS BRAVO.	0.00		1,054,793.64		1,054,793.64	0.00
12354022001026002064	CONSTRUCCION DE PAVIMENTO CON CONCRETO HIDRAULICO EN EL ANDADOR ORQUIDEA, DE LA COLONIA RICARDO FLORES MAGON, LOC. DE CHILPANCINGO, MUNICIPIO DE CHILPANCINGO DE LOS BRAVO.	0.00		747,912.27		747,912.27	0.00
12354022001026002065	CONSTRUCCION DE PAVIMENTO CON CONCRETO HIDRAULICO EN LA CALLE MERCURIO, DE LA COLONIA VILLAS CAMINO SUR, LOC. DE CHILPANCINGO, MUNICIPIO DE CHILPANCINGO DE LOS BRAVO.	0.00		394,587.21		394,587.21	0.00
12354022001026002066	CONSTRUCCION DE PAVIMENTO CON CONCRETO HIDRAULICO EN LA CALLE MARTIRES DEL 2 DE HEROES, EN LA LOC. DE MAZATLAN, MUNICIPIO DE CHILPANCINGO DE LOS BRAVO.	0.00		799,873.10		799,873.10	0.00
12354022001026002067	CONSTRUCCION DE PAVIMENTO CON CONCRETO HIDRAULICO EN LA CALLE FRANCISCO GONZALEZ BOCANEGRA, TRAMO: CALLE FCO JAVIER CLAVIERO-CALLE NETZAHUALCOYOTL, DE LA COLONIA OBRERA, EN LA LOC. DE CHILPANCINGO, MUNICIPIO DE CHILPANCINGO DE LOS BRAVO.	0.00		1,253,560.21		1,253,560.21	0.00
12354022001026002068	CONSTRUCCION DE PAVIMENTO CON CONCRETO HIDRAULICO EN LA CALLE PROF. LUCIO CABANAS, DE LA COLONIA UNIDAD MAGISTERIAL, EN LA LOC. DE CHILPANCINGO, MUNICIPIO DE CHILPANCINGO DE LOS BRAVO.	0.00		527,330.51		527,330.51	0.00
12354022001026002069	CONSTRUCCION DE PAVIMENTO CON CONCRETO HIDRAULICO EN LA CALLE ITZCOATL, TRAMO: CALLE ACAMAPICHTLI-CALLE TIZOC, EN EL FRACCIONAMIENTO AZTECAS, EN LA LOC. DE CHILPANCINGO, MUNICIPIO DE CHILPANCINGO DE LOS BRAVO.	0.00		995,553.74		995,553.74	0.00
12354022001026002070	CONSTRUCCION DE PAVIMENTO CON CONCRETO HIDRAULICO EN LA CALLE MIGUEL HIDALGO, DE LA COLONIA ANTORCHA POPULAR, EN LA LOC. DE CHILPANCINGO, MUNICIPIO DE CHILPANCINGO DE LOS BRAVO.	0.00		1,155,344.13		1,155,344.13	0.00
12354022001026002071	REHABILITACION DE CAMINO RURAL TRAMO: CRUCEO PIEDRA LIADA-LA ESFERANZA, MUNICIPIO DE CHILPANCINGO DE LOS BRAVO.	0.00		842,758.95		842,758.95	0.00

*[Handwritten signature and stamp]*



M. Ayuntamiento Municipal Constitucional de Chilpancingo, Gro. CONTRALORIA INTERNA MUNICIPAL

*[Handwritten signature]*





H. AYUNTAMIENTO MUNICIPAL DE CHILPANCINGO, GRO.

SECRETARIA DE FINANZAS Y ADMINISTRACION

CONSOLIDADO



BALANZA DE COMPROBACION DEL 1 DE ENERO AL 31 DE DICIEMBRE DEL 2019

C U E N T A	C O N C E P T O	SALDOS INICIALES		M O V I M I E N T O S		SALDOS ACUMULADOS	
		AL 1 DE ENERO DE 2019		ENERO - DICIEMBRE 2019		AL 31 DE DICIEMBRE DE 2019	
		DEBE	HABER	DEBE	HABER	DEBE	HABER
12354022001026002072	REHABILITACION DE CAMINO RURAL TRAMO: SANTA BARBARA-JALEACA DE CATALAN.	0.00		694,293.99		694,293.99	0.00
12354022001026002073	REHABILITACION DE CAMINO RURAL TRAMO: CRUCERO INSCUINATUYAC-CARRIZAL DE PINZON-SANTA RITA, MUNICIPIO DE CHILPANCINGO DE LOS BRAVO.	0.00		345,954.05		345,954.05	0.00
12354022001026002074	REHABILITACION DE CAMINO RURAL TRAMO: SANTA BARBARA-SANTA RITA, MUNICIPIO DE CHILPANCINGO DE LOS BRAVO.	0.00		226,659.55		226,659.55	0.00
12354022001026002075	REHABILITACION DE CAMINO RURAL TRAMO: XALTANGUIS-RIO VERDE, MUNICIPIO DE CHILPANCINGO DE LOS BRAVO.	0.00		858,253.41		858,253.41	0.00
12354022001026002076	OMILTEMI-CHAUTIPAN-JALEACA DE CATALAN, MUNICIPIO DE CHILPANCINGO DE LOS BRAVO.	0.00		524,895.80		524,895.80	0.00
12354022001026002077	REHABILITACION DE CAMINO RURAL TRAMO: CHILPANCINGO-LLANOS DE TEPOXTEPEC-CHACUALCINGO, MUNICIPIO DE CHILPANCINGO DE LOS BRAVO.	0.00		233,817.22		233,817.22	0.00
12354022001026002078	REHABILITACION DE CAMINO RURAL TRAMO: SAN VICENTE-EL AHUJITO, MUNICIPIO DE CHILPANCINGO DE LOS BRAVO.	0.00		155,082.85		155,082.85	0.00
12354022001026002079	REHABILITACION DE CAMINO RURAL TRAMO: CRUCERO LA CUMBRE-HIRCON DE ALCAPARROSA-AGUA-HERNANDEZ, MUNICIPIO DE CHILPANCINGO DE LOS BRAVO.	0.00		210,435.50		210,435.50	0.00
12354022001026002080	REHABILITACION DE ALUMBRADO PUBLICO EN LA ZONA PONIENTE DE LA LOC DE CHILPANCINGO, MUNICIPIO DE CHILPANCINGO DE LOS BRAVO.	0.00		820,092.16		820,092.16	0.00
12354022001026002081	REHABILITACION DE ALUMBRADO PUBLICO EN LA ZONA ORIENTE DE LA LOC DE CHILPANCINGO, MUNICIPIO DE CHILPANCINGO DE LOS BRAVO.	0.00		1,176,832.25		1,176,832.25	0.00
12354022001026002082	REHABILITACION DE ANDADORES Y FLAZOLETA EN LOS ESPACIOS PUBLICOS DE LAS INSTALACIONES DE LA FERIA DE NAVIDAD Y AÑO NUEVO DE LA LOC DE CHILPANCINGO, MUNICIPIO DE CHILPANCINGO DE LOS BRAVO.	0.00		1,162,282.02		1,162,282.02	0.00
12354022001026002083	REHABILITACION DE JARDINERAS EN LA COLONIA CENTRO DE LA LOC DE CHILPANCINGO, MUNICIPIO DE CHILPANCINGO DE LOS BRAVO.	0.00		904,447.05		904,447.05	0.00
12354022001026002084	PAVIMENTACION DEL CAMINO RURAL A SAN VICENTE TRAMO: DEL KM 0+000 AL KM 20+000. SUBTRAMO: DEL KM 6+000 AL 8+300, MUNICIPIO DE CHILPANCINGO DE LOS BRAVO. (CONVENIO DE COORDINACION CON CICAEG).	0.00		14,909,361.49		14,909,361.49	0.00
12354022001026002085	REHABILITACION DE CAMINO RURAL EN LA LOC. DE EL CIRUELAR, MUNICIPIO DE CHILPANCINGO DE LOS BRAVO.	0.00		491,410.82		491,410.82	0.00
12354022001026002086	REHABILITACION DE PAVIMENTO CON MEZCLA ASFALTICA EN CALIENTE EN LA CALLE VELAZQUEZ DE LEON TRAMO: CALLE HEROINAS DEL SUR-CALLE ACAPULCO, DE LA COLONIA LOS	0.00		662,728.52		662,728.52	0.00

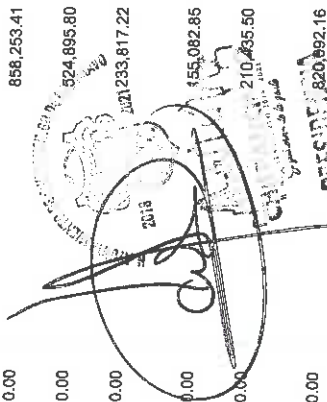
  
 PRESIDENTE DEL AYUNTAMIENTO MUNICIPAL DE CHILPANCINGO



Ayuntamiento Municipal Constitucional de Chilpancingo, Gro.
   
 CONDOMINIO MUNICIPAL



H. AYUNTAMIENTO MUNICIPAL DE CHILPANCINGO, GRO.

SECRETARIA DE FINANZAS Y ADMINISTRACION

CONSOLIDADO



BALANZA DE COMPROBACION DEL 1 DE ENERO AL 31 DE DICIEMBRE DEL 2019

C U E N T A	C O N C E P T O	SALDOS INICIALES		M O V I M I E N T O S		SALDOS ACUMULADOS	
		AL 1 DE ENERO DE 2019		ENERO - DICIEMBRE 2019		AL 31 DE DICIEMBRE DE 2019	
		DEBE	HABER	DEBE	HABER	DEBE	HABER
12354022001026002087	ANGELES, LOC DE CHILPANCINGO, MUNICIPIO DE CHILPANCINGO DE LOS BRAVO.	0.00		109,895.22	109,895.22	0.00	0.00
12354022001026002088	REHABILITACION DE LA PLAZOLETA EN EL BARRIO DE SAN ANTONIO, EN LA LOC. DE CHILPANCINGO, MUNICIPIO DE CHILPANCINGO DE LOS BRAVO.	0.00		721,476.73	721,476.73	0.00	0.00
12354022002	REHABILITACION DE ACCESO A LA OBRA DE TOMA EN LA LOC DE EL CALVARIO, MUNICIPIO DE CHILPANCINGO DE LOS BRAVO.	0.00		405,674.76	405,674.76	0.00	0.00
12354022002026	URBANIZACION (RENDIMIENTOS FINANCIEROS) EJERCICIO 2019	0.00		405,674.76	405,674.76	0.00	0.00
12354022002026002	CONTRATO	0.00		405,674.76	405,674.76	0.00	0.00
12354022002026001	REHABILITACION DE PUENTE PEATONAL EN LA LOCALIDAD DE EL CIRUELAR, MUNICIPIO DE CHILPANCINGO DE LOS BRAVO.	0.00		405,674.76	405,674.76	0.00	0.00
12354023	FONDO DE APORTACIONES PIFORT DE LOS MPIOIS	0.00		8,704,194.49	8,704,194.49	0.00	0.00
12354023026	EJERCICIO 2019	0.00		8,704,194.49	8,704,194.49	0.00	0.00
12354023001	URBANIZACION	0.00		8,704,194.49	8,704,194.49	0.00	0.00
12354023026001	CONSTRUCCION DE RELLENO SANITARIO EL HUITECO, PRIMERA ETAPA, EN EL MUNICIPIO DE CHILPANCINGO, GRO	0.00		7,389,654.50	7,389,654.50	480,000.00	480,000.00
12354023026001002	CONSTRUCCION DE RELLENO SANITARIO EL HUITECO, SEGUNDA ETAPA, EN EL MUNICIPIO DE CHILPANCINGO, GRO	0.00		0.00	0.00	-480,000.00	-480,000.00
12354023026001003	REHABILITACION DE ACCESOS Y REORDENAMIENTO EN EL RELLENO SANITARIO CONSTRUCCION PRIORITARIOS PARA LA PREVENISION DE CONTINGENCIAS PARA EL PROYECTO DEL RELLENO SANITARIO DENOMINADO "EL HUITECO" UBICADO EN EL KM 4.5 DE LA CARRETERA LIBREMIENTO CHILPANCINGO-TIXTLA	0.00		464,000.00	464,000.00	0.00	0.00
12354023026001004	ABIERTO PRIMERA ETAPA, EN EL MUNICIPIO DE CHILPANCINGO DE LOS BRAVO.	0.00		427,539.99	427,539.99	0.00	0.00
12354023026001007	CONSTRUCCIONES EN PROCESO EN BIENES PROPIOS	0.00		423,000.00	423,000.00	0.00	0.00
1236	EDIFICACION NO HABITACIONAL EN PROCESO	0.00		1,034,321.90	1,034,321.90	0.00	0.00
12362	OBRAS DE CONSTRUCCION PARA EDIFICACION NO HABITACIONAL	0.00		1,034,321.90	1,034,321.90	0.00	0.00
12362001	FONDO PARA LA INFRAESTRUCTURA SOCIAL MUNICIPAL	0.00		1,034,321.90	1,034,321.90	0.00	0.00
12362001022	EJERCICIO 2019	0.00		1,034,321.90	1,034,321.90	0.00	0.00
12362001022026	AGONDIIONAMIENTO DE ESPACIOS FISICOS	0.00		1,034,321.90	1,034,321.90	0.00	0.00
12362001022026001	REHABILITACION DE MODULOS SANITARIOS DEL H. AYUNTAMIENTO MUNICIPAL (PRODIM)	0.00		1,034,321.90	1,034,321.90	0.00	0.00
12362001022026001001		0.00		203,208.78	203,208.78	0.00	0.00

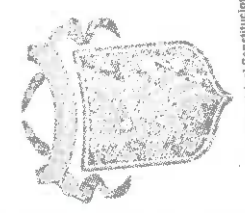
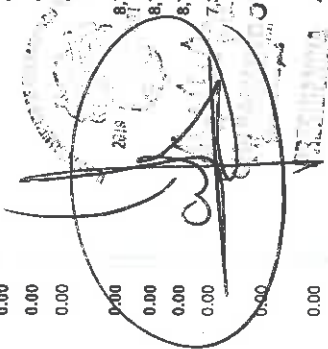

H. Ayuntamiento Municipal de Chilpancingo, Gro. Ayuntamiento Municipal de Chilpancingo, Gro. Ayuntamiento Municipal de Chilpancingo, Gro.



H. AYUNTAMIENTO MUNICIPAL DE CHILPANCINGO, GRO.

SECRETARIA DE FINANZAS Y ADMINISTRACION

CONSOLIDADO



BALANZA DE COMPROBACION DEL 1 DE ENERO AL 31 DE DICIEMBRE DEL 2019

C U E N T A	C O N C E P T O	SALDOS INICIALES		M O V I M I E N T O S		SALDOS ACUMULADOS	
		AL 1 DE ENERO DE 2019		ENERO - DICIEMBRE 2019		AL 31 DE DICIEMBRE DE 2019	
		DEBE	HABER	DEBE	HABER	DEBE	HABER
12362001022026001002	REHABILITACION DEL EDIFICIO DEL H. AYUNTAMIENTO MUNICIPAL (PRODIM)	0.00		448,674.70	448,674.70	0.00	0.00
12362001022026001003	REMODELACION DE LAS OFICINAS DE LA SECRETARIA DE OBRAS PUBLICAS DEL H. AYUNTAMIENTO MUNICIPAL DE CHILPANCINGO DE LOS BRAVO (PRODIM)	0.00		199,978.77	199,978.77	0.00	0.00
12362001022026001004	ADQUISICION DE MOBILIARIO PARA LA REMODELACION DE LAS OFICINAS DEL H. AYUNTAMIENTO MUNICIPAL DE CHILPANCINGO DE LOS BRAVO (PRODIM)	0.00		182,459.65	182,459.65	0.00	0.00
124	BIENES MUEBLES	107,919,264.99		10,516,718.64	0.00	118,435,983.63	
1241	MOBILIARIO Y EQUIPO DE ADMINISTRACION	10,131,493.95		2,189,529.39	0.00	12,320,023.34	
12411	MUEBLES DE OFICINA Y ESTANTERIA	2,772,937.31		0.00	0.00	2,772,937.31	
12411001	GASTO CORRIENTE	1,471,604.32		0.00	0.00	1,471,604.32	
12411001005	ADMON 2012 - 2015	1,471,604.32		0.00	0.00	1,471,604.32	
12411001005001	MUEBLES DE OFICINA Y ESTANTERIA	1,471,604.32		0.00	0.00	1,471,604.32	
12411002	FONDO DE APORT P/INFRA SOC MPAL	657,696.37		0.00	0.00	657,696.37	
12411002005	ADMON 2012 - 2015	657,696.37		0.00	0.00	657,696.37	
12411002005001	MOBILIARIO	657,696.37		0.00	0.00	657,696.37	
12411003	FONCO DE APORT P/IFORT DE LOS MPIO	21,320.98		0.00	0.00	21,320.98	
12411003004	ADMON 2009 - 2012	21,320.98		0.00	0.00	21,320.98	
12411003004001	MUEBLES DE OFICINA Y ESTANTERIA	21,320.98		0.00	0.00	21,320.98	
12411004	CONVENIOS	224,999.99		0.00	0.00	224,999.99	
12411004005	ADMON 2012 - 2015	224,999.99		0.00	0.00	224,999.99	
12411004005001	MOBILIARIO	224,999.99		0.00	0.00	224,999.99	
12411021	GASTO CORRIENTE	397,315.65		0.00	0.00	397,315.65	
12411021020	ADMON 2015-2018	152,120.23		0.00	0.00	152,120.23	
12411021020001	MOBILIARIO	152,120.23		0.00	0.00	152,120.23	
12411021021	EJERCICIO 2016	229,317.32		0.00	0.00	229,317.32	
12411021021001	MOBILIARIO	229,317.32		0.00	0.00	229,317.32	
12411021022	EJERCICIO 2017	5,799.00		0.00	0.00	5,799.00	
12411021022001	MOBILIARIO	5,799.00		0.00	0.00	5,799.00	
12411021022001002	ENFRADOR Y CALENTADOR MABE COLO BLANCO	2,899.00		0.00	0.00	2,899.00	
12411021022001003	5 SILLAS ASIENTO Y RESPALDO TAPIZADA EN TELA COLOR NEGRO GENERICO	2,900.00		0.00	0.00	2,900.00	

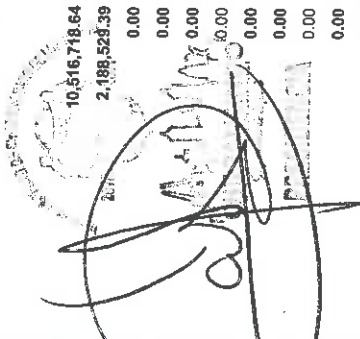
  
 SECRETARIA DE FINANZAS Y ADMINISTRACION  
 AYUNTAMIENTO MUNICIPAL DE CHILPANCINGO



Ayuntamiento Municipal Constitucional de Chilpancingo, Gro.  
 COORDINADOR MUNICIPAL



H. AYUNTAMIENTO MUNICIPAL DE CHILPANCINGO, GRO.

SECRETARIA DE FINANZAS Y ADMINISTRACION

CONSOLIDADO



BALANZA DE COMPROBACION DEL 1 DE ENERO AL 31 DE DICIEMBRE DEL 2019

C U E N T A	C O N C E P T O	SALDOS INICIALES		M O V I M I E N T O S		SALDOS ACUMULADOS	
		AL 1 DE ENERO DE 2019		ENERO - DICIEMBRE 2019		AL 31 DE DICIEMBRE DE 2019	
		DEBE	HABER	DEBE	HABER	DEBE	HABER
12411021023	EJERCICIO 2017 (OCT-DIC)	10,079.10		0.00		10,079.10	
12411021023001	MOBILIARIO	10,079.10		0.00		10,079.10	
12411021023001001	ESCRITORIOS CUATRA BASICO (1)	2,385.20		0.00		2,385.20	
12411021023001002	ESCRITORIOS CUATRA BASICO (2)	2,385.20		0.00		2,385.20	
12411021023001003	ESCRITORIOS CUATRA BASICO (3)	2,385.20		0.00		2,385.20	
12411021023001004	SILLA EJECUTIVA TOTAL BLACK, CON DESCANZA	1,874.50		0.00		1,874.50	
12411021023001005	SILLA PIEL N.Y. (IMITACION) CON DESCANZA	1,049.00		0.00		1,049.00	
124113	BRAZOS, COGILOR, NEGRO						
124113001	EQUIPO DE COMPUTO Y DE TECNOLOGIAS DE LA INFORMACION	7,213,850.14		2,186,529.39		9,400,379.53	
124113001005	GASTO CORRIENTE	2,131,728.69		0.00		2,131,728.69	
1241130010050005	ADMON 2012 - 2015	2,131,728.69		0.00		2,131,728.69	
124113002	EQUIPO DE COMPUTO Y TEC. DE LA INF.	2,131,728.69		0.00		2,131,728.69	
124113002005	FONDO DE APORTE P/INFRA SOC MPAL	1,262,518.24		0.00		1,262,518.24	
124113002005001	ADMON 2012 - 2015	1,262,518.24		0.00		1,262,518.24	
124113003	BIENES INFORMATICOS	1,262,518.24		0.00		1,262,518.24	
124113003005	FONDO DE APORTE P/INFRA DE LOS MPIO	1,262,518.24		0.00		1,262,518.24	
1241130030050005	ADMON 2012-2015	403,728.29		0.00		403,728.29	
124113004	BIENES INFORMATICOS	403,728.29		0.00		403,728.29	
124113004005	CONVENIOS	403,728.29		0.00		403,728.29	
1241130040050001	ADMON 2012 - 2015	65,076.00		0.00		65,076.00	
1241130040050001001	EQUIPO Y APARATOS DE COMUNICACION	65,076.00		0.00		65,076.00	
124113021	GASTO CORRIENTE	65,076.00		0.00		65,076.00	
124113021020	ADMINISTRACION 2015 - 2018	2,538,176.84		14,500.00		2,552,676.84	
124113021020001	BIENES INFORMATICOS	667,395.22		0.00		667,395.22	
124113021021	EJERCICIO 2016	667,395.22		0.00		667,395.22	
124113021021001	BIENES INFORMATICOS	1,601,136.93		0.00		1,601,136.93	
124113021021001001	BIENES INFORMATICOS	1,601,136.93		0.00		1,601,136.93	
124113021022	EJERCICIO 2017	1,601,136.93		0.00		1,601,136.93	
124113021022001	BIENES INFORMATICOS	236,860.82		0.00		236,860.82	
124113021022001001	EQUIPO ALL CINE ACER AZ1-602MD62 (PROCESADOR CELERON, RAM 2GB, DISCO DURO 500GB Y PANTALLA 18.5")	236,860.82		0.00		236,860.82	
124113021022001002	MULTIFUN CANON PIXMA G2100	8,150.00		0.00		8,150.00	
124113021022001003	COMPUTADORA LENOVO AIO 4MB RAM, HD500GB, PANTALLA LED 23" NS: MU0ASSJA.	3,149.10		0.00		3,149.10	
		13,873.60		0.00		13,873.60	

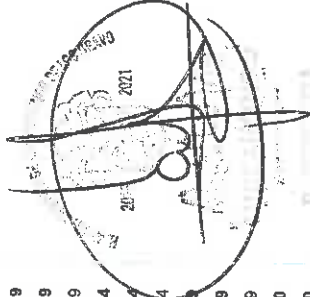

H. Ayuntamiento Municipal Constitucional de Chilpancingo, Gro. SECRETARIA DE FINANZAS Y ADMINISTRACION





H. AYUNTAMIENTO MUNICIPAL DE CHILPANCINGO, GRO.

SECRETARIA DE FINANZAS Y ADMINISTRACION

CONSOLIDADO



BALANZA DE COMPROBACION DEL 1 DE ENERO AL 31 DE DICIEMBRE DEL 2019

C U E N T A	C O N C E P T O	SALDOS INICIALES		M O V I M I E N T O S		SALDOS ACUMULADOS	
		AL 1 DE ENERO DE 2019		ENERO - DICIEMBRE 2019		AL 31 DE DICIEMBRE DE 2019	
		DEBE	HABER	DEBE	HABER	DEBE	HABER
12413021022001004	COMPUTADORA HP E2 20C005LA (TODO EN UNO). N°1	30,404.30		0.00		30,404.30	
12413021022001005	COMPUTADORA HP E2 20C005LA (TODO EN UNO). N°2	30,404.30		0.00		30,404.30	
12413021022001006	COMPUTADORA HP NB PEN15-AY008LA.	14,444.77		0.00		14,444.77	
12413021022001007	MULTIFUN HP OFFICE JETPRO 87.	4,800.60		0.00		4,800.60	
12413021022001008	IMPRESORA MULTIFUNCIONAL EPSON ECOTANK L575 NS: W98Y087849	5,300.01		0.00		5,300.01	
12413021022001009	SOFTWARE KIT INTEGRADOR CFDC CONNECT IMPRESORA HP LASERTJET PRO M402N MONOCROMATICA.	6,957.68		0.00		6,957.68	
12413021022001010	IMPRESORA DE MATRIZ EPSON FX-890 DE 9 PINES. 680 CPSM PARALELO 1.	5,810.57		0.00		5,810.57	
12413021022001011	IMPRESORA DE MATRIZ EPSON FX-890 DE 9 PINES. 680 CPSM PARALELO 2.	10,440.00		0.00		10,440.00	
12413021022001012	IMPRESORA DE MATRIZ EPSON FX-890 DE 9 PINES. 680 CPSM PARALELO 3.	10,440.00		0.00		10,440.00	
12413021022001013	COMPU LENOVO IDEAPAD 300 INTEL 1.6 GHZ, 4GB RAM, TB DISCO DURO	7,500.00		0.00		7,500.00	
12413021022001014	COMPUTADORA ALL IN ONE MARCA: LENOVO 18.5 PULGADAS	9,048.00		0.00		9,048.00	
12413021022001015	SWITCH GIGABIT ADMINISTRABLE PERP. 52 PTOS CAPA 2/3 SMB LINKSYS 1 VPN	14,384.00		0.00		14,384.00	
12413021022001016	SWITCH CISCO SRW248G4, GRIS 10/100 BASE-T	22,942.50		0.00		22,942.50	
12413021022001017	LINKSYS SWITCH GIGABIT ADMINISTRABLE 24 PUERTOS LGS326	11,471.25		0.00		11,471.25	
12413021022001018	LAPTOP ACER ASPIRE F5-573-7957, MEMORIA 16GB, PROCESADOR INTEL CORE I7.	16,900.14		0.00		16,900.14	
12413021023001001	EJERCICIO 2017 (OCT-DIC)	12,983.88		0.00		12,983.88	
12413021023001002	BIENES INFORMATICOS	12,983.88		0.00		12,983.88	
12413021023001003	IMPRESORA TERMICA (1)	4,327.96		0.00		4,327.96	
12413021023001004	IMPRESORA TERMICA (2)	4,327.96		0.00		4,327.96	
12413021023001005	IMPRESORA TERMICA (3)	4,327.96		0.00		4,327.96	
12413021024001001	EJERCICIO 2018	19,799.99		0.00		19,799.99	
12413021024001002	BIENES INFORMATICOS	19,799.99		0.00		19,799.99	
12413021024001003	COMPUTADORA PORTATIL MARCA ACER MOD. A315-51-341F PARTE NX.GN.PAL.030 COLOR NEGRO WINDOWS 10 HOME 64 BITS	10,799.99		0.00		10,799.99	
12413021024001004	COMPUTADORA PORTATIL MARCA HP NOTE BOOK PAVILION 14, MOD. BS012LA-14*, INTEL CORE I3, 6006U, 4BG, 1TB, COLOR BLANCO, WINDOWS 10 HOME NS-5CD8042YFZ.	9,000.00		0.00		9,000.00	
12413021026001001	EJERCICIO 2019	0.00		14,500.00		14,500.00	
12413021026001002	COMPUTADORA DE ESCRITORIO ALL IN ONE HP 24-F000024-F020*-LA AMD A9 8 RAM HD 2TB	0.00		14,500.00		14,500.00	

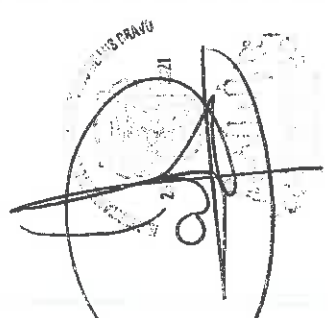

H. Ayuntamiento Municipal Constitucional de Chilpancingo, Gro. SECRETARIA DE FINANZAS Y ADMINISTRACION





H. AYUNTAMIENTO MUNICIPAL DE CHILPANCINGO, GRO.

SECRETARIA DE FINANZAS Y ADMINISTRACION

CONSOLIDADO



BALANZA DE COMPROBACION DEL 1 DE ENERO AL 31 DE DICIEMBRE DEL 2019

C U E N T A	C O N C E P T O	SALDOS INICIALES		M O V I M I E N T O S		SALDOS ACUMULADOS	
		AL 1 DE ENERO DE 2019		ENERO - DICIEMBRE 2019		AL 31 DE DICIEMBRE DE 2019	
		DEBE	HABER	DEBE	HABER	DEBE	HABER
12413 022	PANTALLA 23.8" No SERIE: 8CC8410058	171,917.60		1,753,650.15	0.00	1,925,567.75	
12413 022 021	FONDO DE APORTACIONES PARA LA	167,593.00		0.00	0.00	167,593.00	
12413 022 021 001	INFRAESTRUCTURA SOCIAL MUNICIPAL	167,593.00		0.00	0.00	167,593.00	
12413 022 022	EJERCICIO 2016	4,324.60		0.00	0.00	4,324.60	
12413 022 022 001	EJERCICIO 2017	4,324.60		0.00	0.00	4,324.60	
12413 022 022 001 037	BIENES INFORMATICOS	2,162.30		0.00	0.00	2,162.30	
12413 022 022 001 038	IMPRESORA SAMSUNG SL-M2070 SN:	2,162.30		0.00	0.00	2,162.30	
12413 022 026	IMPRESORA SAMSUNG SL-M2070 SN:	0.00		0.00	0.00	0.00	
12413 022 026 001	06YBB8KJ3B00G1	0.00		1,753,650.15	0.00	1,753,650.15	
12413 022 026 001	EJERCICIO 2019	0.00		14,609.04	0.00	14,609.04	
12413 022 026 002	LENOVO IDEA CENTRE 520-22AST-AMD A-SERIES	0.00					
12413 022 026 002	A6-9220 2.90GHZ-4GB DDR4 SDRAM 1TB HDD-55.9	0.00					
12413 022 026 002	CM (22") 1920X1080 WINDOWS 10 HOME DE	0.00					
12413 022 026 002	ESCRITORIO PLATA, GRABADORA DVD	0.00					
12413 022 026 002	F06000YLD. (1)	0.00					
12413 022 026 002	LENOVO IDEA CENTRE 520-22AST-AMD A-SERIES	0.00		14,609.04	0.00	14,609.04	
12413 022 026 002	A6-9220 2.90GHZ-4GB DDR4 SDRAM 1TB HDD-55.9	0.00					
12413 022 026 002	CM (22") 1920X1080 WINDOWS 10 HOME DE	0.00					
12413 022 026 002	ESCRITORIO PLATA, GRABADORA DVD	0.00					
12413 022 026 002	F06000YLD. (3)	0.00					
12413 022 026 002	LENOVO IDEA CENTRE 520-22AST-AMD A-SERIES	0.00		14,609.04	0.00	14,609.04	
12413 022 026 002	A6-9220 2.90GHZ-4GB DDR4 SDRAM 1TB HDD-55.9	0.00					
12413 022 026 002	CM (22") 1920X1080 WINDOWS 10 HOME DE	0.00					
12413 022 026 002	ESCRITORIO PLATA, GRABADORA DVD	0.00					
12413 022 026 002	F06000YLD. (4)	0.00					
12413 022 026 002	LENOVO IDEA CENTRE 520-22AST-AMD A-SERIES	0.00		14,609.04	0.00	14,609.04	
12413 022 026 002	A6-9220 2.90GHZ-4GB DDR4 SDRAM 1TB HDD-55.9	0.00					
12413 022 026 002	CM (22") 1920X1080 WINDOWS 10 HOME DE	0.00					
12413 022 026 002	ESCRITORIO PLATA, GRABADORA DVD	0.00					
12413 022 026 002	F06000YLD. (5)	0.00					
12413 022 026 002	LENOVO IDEA CENTRE 520-22AST-AMD A-SERIES	0.00		14,609.04	0.00	14,609.04	
12413 022 026 002	A6-9220 2.90GHZ-4GB DDR4 SDRAM 1TB HDD-55.9	0.00					
12413 022 026 002	CM (22") 1920X1080 WINDOWS 10 HOME DE	0.00					
12413 022 026 002	ESCRITORIO PLATA, GRABADORA DVD	0.00					
12413 022 026 002	F06000YLD. (6)	0.00					
12413 022 026 002	LENOVO IDEA CENTRE 520-22AST-AMD A-SERIES	0.00		14,609.04	0.00	14,609.04	
12413 022 026 002	A6-9220 2.90GHZ-4GB DDR4 SDRAM 1TB HDD-55.9	0.00					
12413 022 026 002	CM (22") 1920X1080 WINDOWS 10 HOME DE	0.00					
12413 022 026 002	ESCRITORIO PLATA, GRABADORA DVD	0.00					
12413 022 026 002	F06000YLD. (7)	0.00					
12413 022 026 002	LENOVO IDEA CENTRE 520-22AST-AMD A-SERIES	0.00		14,609.04	0.00	14,609.04	
12413 022 026 002	A6-9220 2.90GHZ-4GB DDR4 SDRAM 1TB HDD-55.9	0.00					
12413 022 026 002	CM (22") 1920X1080 WINDOWS 10 HOME DE	0.00					

AYUNTAMIENTO DE CHILPANCINGO, GRO. 2019

SECRETARIA DE FINANZAS Y ADMINISTRACION

CHILPANCINGO

SECRETARIA DE FINANZAS Y ADMINISTRACION

CONTRALORIA MUNICIPAL



H. AYUNTAMIENTO MUNICIPAL DE CHILPANCINGO, GRO.

SECRETARIA DE FINANZAS Y ADMINISTRACION

CONSOLIDADO



BALANZA DE COMPROBACIÓN DEL 1 DE ENERO AL 31 DE DICIEMBRE DEL 2019

C U E N T A	C O N C E P T O	SALDOS INICIALES		M O V I M I E N T O S		SALDOS ACUMULADOS	
		AL 1 DE ENERO DE 2019		ENERO - DICIEMBRE 2019		AL 31 DE DICIEMBRE DE 2019	
		DEBE	HABER	DEBE	HABER	DEBE	HABER
12413022026009	ESCRITORIO PLATA, GRABADORA DVD F06000YLD.(8) LENOVO IDEA CENTRE 520-22AST-AMD A-SERIES A6-9220 2.80GHZ-4GB DDR4 SDRAM 1TB HDD-55.9 CM (22") 1920X1080 WINDOWS 10 HOME DE ESCRITORIO PLATA, GRABADORA DVD F06000YLD.(9)	0.00		14,609.04	0.00	14,609.04	
12413022026010	HP 14-CK0010LA INTEL CORE I3, 4 GB, 1000 GB, 14 PULGADAS, WINDOWS 10 HOME, INTEL HD GRAPHICS 620 3PX23LA.(1)	0.00		10,680.46	0.00	10,680.46	
12413022026011	HP 14-CK0010LA INTEL CORE I3, 4 GB, 1000 GB, 14 PULGADAS, WINDOWS 10 HOME, INTEL HD GRAPHICS 620 3PX23LA.(2)	0.00		10,680.46	0.00	10,680.46	
12413022026012	HP 14-CK0010LA INTEL CORE I3, 4 GB, 1000 GB, 14 PULGADAS, WINDOWS 10 HOME, INTEL HD GRAPHICS 620 3PX23LA.(3)	0.00		10,680.46	0.00	10,680.46	
12413022026013	HP 14-CK0010LA INTEL CORE I3, 4 GB, 1000 GB, 14 PULGADAS, WINDOWS 10 HOME, INTEL HD GRAPHICS 620 3PX23LA.(4)	0.00		10,680.46	0.00	10,680.46	
12413022026014	HP 14-CK0010LA INTEL CORE I3, 4 GB, 1000 GB, 14 PULGADAS, WINDOWS 10 HOME, INTEL HD GRAPHICS 620 3PX23LA.(5)	0.00		10,680.46	0.00	10,680.46	
12413022026015	HP 14-CK0010LA INTEL CORE I3, 4 GB, 1000 GB, 14 PULGADAS, WINDOWS 10 HOME, INTEL HD GRAPHICS 620 3PX23LA.(6)	0.00		10,680.46	0.00	10,680.46	
12413022026016	HP 14-CK0010LA INTEL CORE I3, 4 GB, 1000 GB, 14 PULGADAS, WINDOWS 10 HOME, INTEL HD GRAPHICS 620 3PX23LA.(7)	0.00		10,680.46	0.00	10,680.46	
12413022026017	HP 14-CK0010LA INTEL CORE I3, 4 GB, 1000 GB, 14 PULGADAS, WINDOWS 10 HOME, INTEL HD GRAPHICS 620 3PX23LA.(8)	0.00		10,680.46	0.00	10,680.46	
12413022026018	HP 14-CK0010LA INTEL CORE I3, 4 GB, 1000 GB, 14 PULGADAS, WINDOWS 10 HOME, INTEL HD GRAPHICS 620 3PX23LA.(9)	0.00		10,680.46	0.00	10,680.46	
12413022026019	HP 14-CK0010LA INTEL CORE I3, 4 GB, 1000 GB, 14 PULGADAS, WINDOWS 10 HOME, INTEL HD GRAPHICS 620 3PX23LA.(10)	0.00		10,680.46	0.00	10,680.46	
12413022026020	HP 250G6, INTEL CORE I7, 8GB, 1000GB, 15.6 PULGADAS, WINDOWS 10 HOME 1ZS09ELIFE2T.(1)	0.00		19,597.04	0.00	19,597.04	
12413022026021	HP 250G6, INTEL CORE I7, 8GB, 1000GB, 15.6 PULGADAS, WINDOWS 10 HOME 1ZS09ELIFE2T.(2)	0.00		19,597.04	0.00	19,597.04	
12413022026022	HP 250G6, INTEL CORE I7, 8GB, 1000GB, 15.6 PULGADAS, WINDOWS 10 HOME 1ZS09ELIFE2T.(3)	0.00		19,597.04	0.00	19,597.04	
12413022026023	HP 250G6, INTEL CORE I7, 8GB, 1000GB, 15.6 PULGADAS, WINDOWS 10 HOME 1ZS09ELIFE2T.(4)	0.00		19,597.04	0.00	19,597.04	
12413022026024	HP 250G6, INTEL CORE I7, 8GB, 1000GB, 15.6 PULGADAS, WINDOWS 10 HOME 1ZS09ELIFE2T.(5)	0.00		19,597.04	0.00	19,597.04	
12413022026025	HP 250G6, INTEL CORE I7, 8GB, 1000GB, 15.6 PULGADAS, WINDOWS 10 HOME 1ZS09ELIFE2T.	0.00		19,597.04	0.00	19,597.04	
Coram/ Balanza		0.00		19,597.04	0.00	19,597.04	

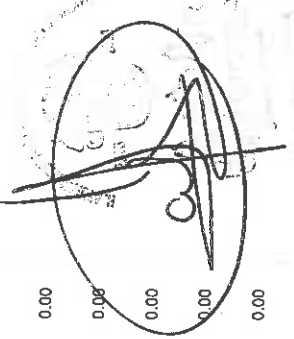

Ayuntamiento Municipal Constitucional del  
 Chilpancingo, Gro.  
 CONSERVADOR DEL TERMINO MUNICIPAL



H. AYUNTAMIENTO MUNICIPAL DE CHILPANCINGO, GRO.

SECRETARIA DE FINANZAS Y ADMINISTRACION

CONSOLIDADO



BALANZA DE COMPROBACION DEL 1 DE ENERO AL 31 DE DICIEMBRE DEL 2019

C U E N T A	C O N C E P T O	SALDOS INICIALES		M O V I M I E N T O S		SALDOS ACUMULADOS	
		AL 1 DE ENERO DE 2019		ENERO - DICIEMBRE 2019		AL 31 DE DICIEMBRE DE 2019	
		DEBE	HABER	DEBE	HABER	DEBE	HABER
12413022026026	(6) HP 250G6, INTEL CORE I7, 8GB, 1000GB, 15.6 PULGADAS, WINDOWS 10 HOME 1ZS09ELIFEZT.	0.00		19,597.04	0.00	19,597.04	
12413022026027	(7) IMPRESORA HP HP 2134, 4800x1200 DPI, INTECCION DE TINTA, 20 PPM, 1000 PAGINAS POR MES 4HM22A. (1)	0.00		1,995.51	0.00	1,995.51	
12413022026028	IMPRESORA HP HP 2134, 4800x1200 DPI, INTECCION DE TINTA, 20 PPM, 1000 PAGINAS POR MES 4HM22A. (2)	0.00		1,995.51	0.00	1,995.51	
12413022026029	IMPRESORA HP HP 2134, 4800x1200 DPI, INTECCION DE TINTA, 20 PPM, 1000 PAGINAS POR MES 4HM22A. (3)	0.00		1,995.51	0.00	1,995.51	
12413022026030	IMPRESORA HP HP 2134, 4800x1200 DPI, INTECCION DE TINTA, 20 PPM, 1000 PAGINAS POR MES 4HM22A. (4)	0.00		1,995.51	0.00	1,995.51	
12413022026031	IMPRESORA HP HP 2134, 4800x1200 DPI, INTECCION DE TINTA, 20 PPM, 1000 PAGINAS POR MES 4HM22A. (5)	0.00		1,995.51	0.00	1,995.51	
12413022026032	IMPRESORA HP HP 2134, 4800x1200 DPI, INTECCION DE TINTA, 20 PPM, 1000 PAGINAS POR MES 4HM22A. (6)	0.00		1,995.51	0.00	1,995.51	
12413022026033	IMPRESORA HP HP 2134, 4800x1200 DPI, INTECCION DE TINTA, 20 PPM, 1000 PAGINAS POR MES 4HM22A. (7)	0.00		1,995.51	0.00	1,995.51	
12413022026034	IMPRESORA HP HP 2134, 4800x1200 DPI, INTECCION DE TINTA, 20 PPM, 1000 PAGINAS POR MES 4HM22A. (8)	0.00		1,995.51	0.00	1,995.51	
12413022026035	IMPRESORA HP HP 2134, 4800x1200 DPI, INTECCION DE TINTA, 20 PPM, 1000 PAGINAS POR MES 4HM22A. (9)	0.00		1,995.51	0.00	1,995.51	
12413022026042	IMPRESORA HP HP 2134, 4800x1200 DPI, INTECCION DE TINTA, 20 PPM, 1000 PAGINAS POR MES 4HM22A. (10)	0.00		1,995.51	0.00	1,995.51	
12413022026043	IMPRESORA EPSON FX390 II C11CF37201. (1)	0.00		11,919.00	0.00	11,919.00	
12413022026044	IMPRESORA EPSON FX390 II C11CF37201. (2)	0.00		11,919.00	0.00	11,919.00	
12413022026045	IMPRESORA EPSON FX390 II C11CF37201. (3)	0.00		11,919.00	0.00	11,919.00	
12413022026046	IMPRESORA EPSON FX390 II C11CF37201. (4)	0.00		11,919.00	0.00	11,919.00	
12413022026047	IMPRESORA EPSON FX390 II C11CF37201. (5)	0.00		11,919.00	0.00	11,919.00	
12413022026048	IMPRESORA EPSON FX390 II C11CF37201. (6)	0.00		11,919.00	0.00	11,919.00	
12413022026049	IMPRESORA EPSON FX390 II C11CF37201. (7)	0.00		11,919.00	0.00	11,919.00	
12413022026050	IMPRESORA EPSON FX390 II C11CF37201. (8)	0.00		11,919.00	0.00	11,919.00	
12413022026051	IMPRESORA EPSON FX390 II C11CF37201. (9)	0.00		11,919.00	0.00	11,919.00	
12413022026052	IMPRESORA EPSON FX390 II C11CF37201. (10)	0.00		11,919.00	0.00	11,919.00	
12413022026053	DCPL5500DN. (1)	0.00		7,716.32	0.00	7,716.32	

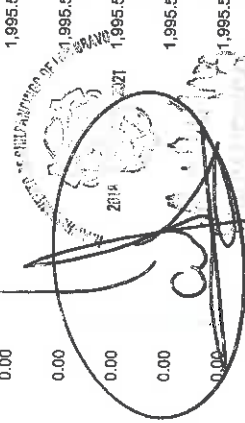
  
 SECRETARIA DE FINANZAS Y ADMINISTRACION  
 2019

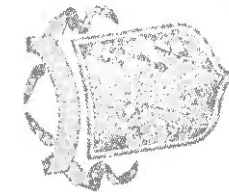

H. Ayuntamiento Municipal Constitucional de Chilpancingo, Gro.  
 C. O. A. G. O. M. U. N. I. C. I. P. A. L.  
 7,716.32



H. AYUNTAMIENTO MUNICIPAL DE CHILPANCINGO, GRO.

SECRETARÍA DE FINANZAS Y ADMINISTRACIÓN

CONSOLIDADO



BALANZA DE COMPROBACIÓN DEL 1 DE ENERO AL 31 DE DICIEMBRE DEL 2019

C U E N T A	C O N C E P T O	SALDOS INICIALES		MOVIMIENTOS		SALDOS ACUMULADOS	
		AL 1 DE ENERO DE 2019		ENERO - DICIEMBRE 2019		AL 31 DE DICIEMBRE DE 2019	
		DEBE	HABER	DEBE	HABER	DEBE	HABER
12413022026048	IMPRESORA MULTIFUNCIONAL BROTHER	0.00		7,716.32		0.00	7,716.32
12413022026049	DCPL5500DN. (2)	0.00		7,716.32		0.00	7,716.32
12413022026050	IMPRESORA MULTIFUNCIONAL BROTHER	0.00		7,716.32		0.00	7,716.32
12413022026051	DCPL5500DN. (3)	0.00		7,716.32		0.00	7,716.32
12413022026052	IMPRESORA MULTIFUNCIONAL BROTHER	0.00		7,716.32		0.00	7,716.32
12413022026053	DCPL5500DN. (4)	0.00		7,716.32		0.00	7,716.32
12413022026054	IMPRESORA MULTIFUNCIONAL BROTHER	0.00		7,716.32		0.00	7,716.32
12413022026055	DCPL5500DN. (5)	0.00		7,716.32		0.00	7,716.32
12413022026056	IMPRESORA MULTIFUNCIONAL BROTHER	0.00		7,716.32		0.00	7,716.32
12413022026057	DCPL5500DN. (6)	0.00		7,716.32		0.00	7,716.32
12413022026058	IMPRESORA MULTIFUNCIONAL BROTHER	0.00		7,716.32		0.00	7,716.32
12413022026059	DCPL5500DN. (7)	0.00		7,716.32		0.00	7,716.32
12413022026060	IMPRESORA MULTIFUNCIONAL BROTHER	0.00		7,716.32		0.00	7,716.32
12413022026061	DCPL5500DN. (8)	0.00		7,716.32		0.00	7,716.32
12413022026062	SWITCH CISCO SG250-26-K9-NA, NEGRO, 24+2	0.00		7,223.33		0.00	7,223.33
12413022026063	SFP SG250-26-K9-NA. (1)	0.00		7,223.33		0.00	7,223.33
12413022026064	SWITCH CISCO SG250-26-K9-NA, NEGRO, 24+2	0.00		7,223.33		0.00	7,223.33
12413022026065	SFP SG250-26-K9-NA. (2)	0.00		7,223.33		0.00	7,223.33
12413022026066	SWITCH CISCO SG250-26-K9-NA, NEGRO, 24+2	0.00		7,223.33		0.00	7,223.33
12413022026067	SFP SG250-26-K9-NA. (3)	0.00		7,223.33		0.00	7,223.33
12413022026068	SWITCH CISCO SG250-26-K9-NA, NEGRO, 24+2	0.00		7,223.33		0.00	7,223.33
12413022026069	SFP SG250-26-K9-NA. (4)	0.00		7,223.33		0.00	7,223.33
12413022026070	SWITCH CISCO SG250-26-K9-NA, NEGRO, 24+2	0.00		7,223.33		0.00	7,223.33
12413022026071	SFP SG250-26-K9-NA. (5)	0.00		7,223.33		0.00	7,223.33
12413022026072	SWITCH CISCO SG250-26-K9-NA, NEGRO, 24+2	0.00		7,223.33		0.00	7,223.33
12413022026073	SFP SG250-26-K9-NA. (6)	0.00		7,223.33		0.00	7,223.33
12413022026074	SWITCH CISCO SG250-26-K9-NA, NEGRO, 24+2	0.00		7,223.33		0.00	7,223.33
12413022026075	SFP SG250-26-K9-NA. (7)	0.00		7,223.33		0.00	7,223.33
12413022026076	SWITCH CISCO SG250-26-K9-NA, NEGRO, 24+2	0.00		7,223.33		0.00	7,223.33
12413022026077	HP AIO 24-F020LA, AMD A9, 88 GB, DDR4, 2 TB,	0.00		16,579.88		0.00	16,579.88
12413022026078	DVD+RW, WINDOWS 10 HOME 3US27AA, (1)	0.00		16,579.88		0.00	16,579.88
12413022026079	HP AIO 24-F020LA, AMD A9, 88 GB, DDR4, 2 TB,	0.00		16,579.88		0.00	16,579.88
12413022026080	DVD+RW, WINDOWS 10 HOME 3US27AA, (2)	0.00		16,579.88		0.00	16,579.88
12413022026081	HP AIO 24-F020LA, AMD A9, 88 GB, DDR4, 2 TB,	0.00		16,579.88		0.00	16,579.88
12413022026082	DVD+RW, WINDOWS 10 HOME 3US27AA, (3)	0.00		16,579.88		0.00	16,579.88
12413022026083	HP AIO 24-F020LA, AMD A9, 88 GB, DDR4, 2 TB,	0.00		16,579.88		0.00	16,579.88
12413022026084	DVD+RW, WINDOWS 10 HOME 3US27AA, (4)	0.00		16,579.88		0.00	16,579.88
12413022026085	HP AIO 24-F020LA, AMD A9, 88 GB, DDR4, 2 TB,	0.00		16,579.88		0.00	16,579.88
12413022026086	DVD+RW, WINDOWS 10 HOME 3US27AA, (5)	0.00		16,579.88		0.00	16,579.88
12413022026087	HP AIO 24-F020LA, AMD A9, 88 GB, DDR4, 2 TB,	0.00		16,579.88		0.00	16,579.88
12413022026088	DVD+RW, WINDOWS 10 HOME 3US27AA, (6)	0.00		16,579.88		0.00	16,579.88
12413022026089	HP AIO 24-F020LA, AMD A9, 88 GB, DDR4, 2 TB,	0.00		16,579.88		0.00	16,579.88
12413022026090	DVD+RW, WINDOWS 10 HOME 3US27AA, (7)	0.00		16,579.88		0.00	16,579.88
12413022026091	HP AIO 24-F020LA, AMD A9, 88 GB, DDR4, 2 TB,	0.00		16,579.88		0.00	16,579.88
12413022026092	DVD+RW, WINDOWS 10 HOME 3US27AA, (8)	0.00		16,579.88		0.00	16,579.88
12413022026093	HP AIO 24-F020LA, AMD A9, 88 GB, DDR4, 2 TB,	0.00		16,579.88		0.00	16,579.88
12413022026094	DVD+RW, WINDOWS 10 HOME 3US27AA, (9)	0.00		16,579.88		0.00	16,579.88
12413022026095	HP AIO 24-F020LA, AMD A9, 88 GB, DDR4, 2 TB,	0.00		16,579.88		0.00	16,579.88
12413022026096	DVD+RW, WINDOWS 10 HOME 3US27AA, (10)	0.00		16,579.88		0.00	16,579.88
12413022026097	HP AIO 24-F020LA, AMD A9, 88 GB, DDR4, 2 TB,	0.00		16,579.88		0.00	16,579.88
12413022026098	DVD+RW, WINDOWS 10 HOME 3US27AA, (11)	0.00		16,579.88		0.00	16,579.88
12413022026099	HP AIO 24-F020LA, AMD A9, 88 GB, DDR4, 2 TB,	0.00		16,579.88		0.00	16,579.88
12413022026100	DVD+RW, WINDOWS 10 HOME 3US27AA, (12)	0.00		16,579.88		0.00	16,579.88
12413022026101	HP AIO 24-F020LA, AMD A9, 88 GB, DDR4, 2 TB,	0.00		16,579.88		0.00	16,579.88
12413022026102	DVD+RW, WINDOWS 10 HOME 3US27AA, (13)	0.00		16,579.88		0.00	16,579.88
12413022026103	HP AIO 24-F020LA, AMD A9, 88 GB, DDR4, 2 TB,	0.00		16,579.88		0.00	16,579.88

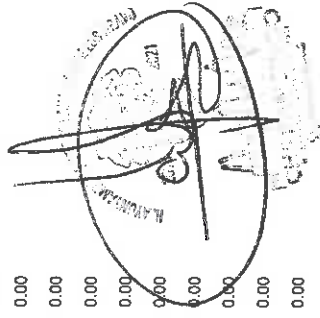

H. Ayuntamiento Municipal de Chilpancingo  
SECRETARÍA DE FINANZAS Y ADMINISTRACIÓN





H. AYUNTAMIENTO MUNICIPAL DE CHILPANCINGO, GRO.

SECRETARIA DE FINANZAS Y ADMINISTRACION

CONSOLIDADO



BALANZA DE COMPROBACION DEL 1 DE ENERO AL 31 DE DICIEMBRE DEL 2019

C U E N T A	C O N C E P T O	SALDOS INICIALES		M O V I M I E N T O S		SALDOS ACUMULADOS	
		AL 1 DE ENERO DE 2019		ENERO - DICIEMBRE 2019		AL 31 DE DICIEMBRE DE 2019	
		DEBE	HABER	DEBE	HABER	DEBE	HABER
12413022026076	DVD+RW, WINDOWS 10 HOME 3US27AA, (14)	0.00		16,579.89	0.00	16,579.89	
12413022026077	HP AIO 24-F020LA, AMD A9, 88 GB, DDR4, 2 TB, DVD+RW, WINDOWS 10 HOME 3US27AA, (15)	0.00		18,539.93	0.00	18,539.93	
12413022026078	LAPTOP HP 240 G7 14" INTEL CORE 5 8265U	0.00		18,539.93	0.00	18,539.93	
12413022026079	DISCO DURO 1 TB RAM 8GB WINDOW S10 HOME, NEGRA SIN 5CG91830PM	0.00		18,539.93	0.00	18,539.93	
12413022026080	LAPTOP HP 240 G7 14" INTEL CORE 5 8265U	0.00		18,539.93	0.00	18,539.93	
12413022026081	DISCO DURO 1 TB RAM 8GB WINDOW S10 HOME, NEGRA SIN 5CG918559K	0.00		18,539.93	0.00	18,539.93	
12413022026082	LAPTOP HP 240 G7 14" INTEL CORE 5 8265U	0.00		18,539.93	0.00	18,539.93	
12413022026083	DISCO DURO 1 TB RAM 8GB WINDOW S10 HOME, NEGRA SIN 5CG9185FBV	0.00		18,539.93	0.00	18,539.93	
12413022026084	LAPTOP HP 240 G7 14" INTEL CORE 5 8265U	0.00		18,539.93	0.00	18,539.93	
12413022026085	DISCO DURO 1 TB RAM 8GB WINDOW S10 HOME, NEGRA SIN 5CG9185FKZ	0.00		18,539.93	0.00	18,539.93	
12413022026086	LAPTOP HP 240 G7 14" INTEL CORE 5 8265U	0.00		18,539.93	0.00	18,539.93	
12413022026087	DISCO DURO 1 TB RAM 8GB WINDOW S10 HOME, NEGRA SIN 5CG9356YRQ	0.00		18,539.93	0.00	18,539.93	
12413022026088	LAPTOP HP 240 G7 14" INTEL CORE 5 8265U	0.00		18,539.93	0.00	18,539.93	
12413022026089	DISCO DURO 1 TB RAM 8GB WINDOW S10 HOME, NEGRA SIN 5CG9356ZCQ	0.00		18,539.93	0.00	18,539.93	
12413022026090	LAPTOP HP 240 G7 14" INTEL CORE 5 8265U	0.00		18,539.93	0.00	18,539.93	
12413022026091	DISCO DURO 1 TB RAM 8GB WINDOW S10 HOME, NEGRA SIN 5CG9356ZPL	0.00		18,539.93	0.00	18,539.93	
12413022026092	LAPTOP HP 240 G7 14" INTEL CORE 5 8265U	0.00		18,539.93	0.00	18,539.93	
12413022026093	DISCO DURO 1 TB RAM 8GB WINDOW S10 HOME, NEGRA SIN 5CG9356ZP5	0.00		18,539.93	0.00	18,539.93	
12413022026094	LAPTOP HP 240 G7 14" INTEL CORE 5 8265U	0.00		18,539.93	0.00	18,539.93	
	DISCO DURO 1 TB RAM 8GB WINDOW S10 HOME, NEGRA SIN 5CG9356ZWD	0.00		18,539.93	0.00	18,539.93	
	LAPTOP HP 240 G7 14" INTEL CORE 5 8265U	0.00		18,539.93	0.00	18,539.93	
	DISCO DURO 1 TB RAM 8GB WINDOW S10 HOME, NEGRA SIN 5CG9356Z8J	0.00		18,539.93	0.00	18,539.93	
	IMPRESORA DE INYECCION EPSON	0.00		12,938.48	0.00	12,938.48	
	WORRKFORCE PRO WF-5190 COLOR SDVY002180	0.00		12,938.48	0.00	12,938.48	
	IMPRESORA DE INYECCION EPSON	0.00		12,938.48	0.00	12,938.48	
	WORRKFORCE PRO WF-5190 COLOR SDVY002195	0.00		12,938.48	0.00	12,938.48	
	IMPRESORA DE INYECCION EPSON	0.00		12,938.48	0.00	12,938.48	
	WORRKFORCE PRO WF-5190 COLOR SDVY002197	0.00		12,938.48	0.00	12,938.48	
	IMPRESORA DE INYECCION EPSON	0.00		12,938.48	0.00	12,938.48	
	WORRKFORCE PRO WF-5190 COLOR SDVY002554	0.00		12,938.48	0.00	12,938.48	
	IMPRESORA DE INYECCION EPSON	0.00		12,938.48	0.00	12,938.48	
	WORRKFORCE PRO WF-5190 COLOR SDVY002699	0.00		12,938.48	0.00	12,938.48	
	IMPRESORA DE INYECCION EPSON	0.00		12,938.48	0.00	12,938.48	
	MULTIFUNCIONAL EPSON ECO TANK L6161	0.00		12,938.47	0.00	12,938.47	
	COLOR TINTA CONTINUA: IMPRESORA, COPIADORA Y ESCANER, SISTEMA DE TANQUES DE TINTA, WIFI DIRECT (INALAMBIRICA-IMPRI	0.00		5,829.58	0.00	5,829.58	
	MENTE DESDE IPAD, IPHONE, ANDROID FACILMENTE	0.00					

2018

SECRETARIA DE FINANZAS Y ADMINISTRACION

2019



H. Ayuntamiento Municipal Constitucional de Chilpancingo, Gro. Ayuntamiento Municipal

SECRETARIA DE FINANZAS Y ADMINISTRACION





H. AYUNTAMIENTO MUNICIPAL DE CHILPANCINGO, GRO.

SECRETARIA DE FINANZAS Y ADMINISTRACION

CONSOLIDADO



BALANZA DE COMPROBACION DEL 1 DE ENERO AL 31 DE DICIEMBRE DEL 2019

C U E N T A	C O N C E P T O	SALDOS INICIALES		M O V I M I E N T O S		SALDOS ACUMULADOS		
		AL 1 DE ENERO DE 2019		ENERO - DICIEMBRE 2019		AL 31 DE DICIEMBRE DE 2019		
		DEBE	HABER	DEBE	HABER	DEBE	HABER	
12413022026095	TABLETAS Y TELEFONOS INTELIGENTES, INCLUYE WI-FI DIRECT X4EA001577 MULTIFUNCIONAL EPSON ECO TANK L6161 COLOR TINTA CONTINUA: IMPRESORA COPIADORA Y ESCANER, SISTEMA DE TANQUES DE TINTA, WI-FI DIRECT (INALAMBIRICA-IMPRIME FACILMENTE DESDE IPAD IPHONE, ANDROID TABLETAS Y TELEFONOS INTELIGENTES, INCLUYE WI-FI DIRECT X4EA001867 MULTIFUNCIONAL EPSON ECO TANK L3150 COLOR TINTA CONTINUA: IMPRESORA COPIADORA Y ESCANER, SISTEMA DE TANQUES DE TINTA, WI-FI DIRECT (INALAMBIRICA-IMPRIME FACILMENTE DESDE IPAD IPHONE, ANDROID TABLETAS Y TELEFONOS INTELIGENTES, INCLUYE WI-FI DIRECT X9E8108294 COMPUTADORA TODO EN UNO HP BUSINESS DESKTOP 205 G3-E SERIES E2-900 4GB RAM-1TB HDD-49.4 CM (19.5") 1600X900 DE ESCRITORIO WINDOW S 10 HOME 64-BIT-AMD RADEON R2 GRAPHICS-GRABADORA DVD No SERIE 8CC92457BP COMPUTADORA TODO EN UNO HP BUSINESS DESKTOP 205 G3-E SERIES E2-900 4GB RAM-1TB HDD-49.4 CM (19.5") 1600X900 DE ESCRITORIO WINDOW S 10 HOME 64-BIT-AMD RADEON R2 GRAPHICS-GRABADORA DVD No SERIE 8CC92457JR COMPUTADORA TODO EN UNO HP BUSINESS DESKTOP 205 G3-E SERIES E2-900 4GB RAM-1TB HDD-49.4 CM (19.5") 1600X900 DE ESCRITORIO WINDOW S 10 HOME 64-BIT-AMD RADEON R2 GRAPHICS-GRABADORA DVD No SERIE 8CC92458BS COMPUTADORA TODO EN UNO HP BUSINESS DESKTOP 205 G3-E SERIES E2-900 4GB RAM-1TB HDD-49.4 CM (19.5") 1600X900 DE ESCRITORIO WINDOW S 10 HOME 64-BIT-AMD RADEON R2 GRAPHICS-GRABADORA DVD No SERIE 8CC92458B2 PC DE ESCRITORIO DELLEMC VOSTRO DESKTOP 3470, PROCESADOR INTEL CORE I7, RAM 8 GB, DD 1TB, INTEL HD GRAPHICS, WINDOWS 40 PRO, MONITOR 19.5", No SERIE 5NQB8R2 COMPUTADORA TODO EN UNO HP BUSINESS DESKTOP 205 G3-E SERIES E2-900 4GB RAM-1TB HDD-49.4 CM (19.5") 1600X900 DE ESCRITORIO WINDOW S 10 HOME 64-BIT-AMD RADEON R2 GRAPHICS-GRABADORA DVD No SERIE 8CC9247GK COMPUTADORA TODO EN UNO HP BUSINESS DESKTOP 205 G3-E SERIES E2-900 4GB RAM-1TB HDD-49.4 CM (19.5") 1600X900 DE ESCRITORIO	0.00		5,829.58	0.00	5,829.58		5,829.58
12413022026096		0.00		3,670.36	0.00	3,670.36	3,670.36	
12413022026097		0.00		11,125.56	0.00	11,125.56	11,125.56	
12413022026098		0.00		11,125.56	0.00	11,125.56	11,125.56	
12413022026102		0.00		11,125.56	0.00	11,125.56	11,125.56	
12413022026103		0.00		11,125.56	0.00	11,125.56	11,125.56	
12413022026104		0.00		11,125.56	0.00	11,125.56	11,125.56	

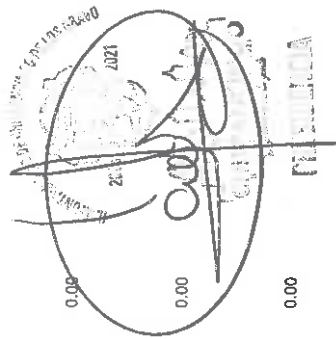

H. Ayuntamiento Municipal de Chilpancingo, Gro. SECRETARIA DE FINANZAS Y ADMINISTRACION



H. AYUNTAMIENTO MUNICIPAL DE CHILPANCINGO, GRO.

SECRETARIA DE FINANZAS Y ADMINISTRACION

CONSOLIDADO



BALANZA DE COMPROBACIÓN DEL 1 DE ENERO AL 31 DE DICIEMBRE DEL 2019

C U E N T A	C O N C E P T O	SALDOS INICIALES		MOVIMIENTOS		SALDOS ACUMULADOS	
		AL 1 DE ENERO DE 2019		ENERO - DICIEMBRE 2019		AL 31 DE DICIEMBRE DE 2019	
		DEBE	HABER	DEBE	HABER	DEBE	HABER
12413022026105	WINDOW S 10 HOME 64-BIT-AMD RADEON R2 8CC92457L3 COMPUTADORA TODO EN UNO HP BUSINESS DESKTOP 205 G3-E SERIES E2-900 4GB RAM-1TB HDD-49.4 CM (19.5"), 1600X900 DE ESCRITORIO WINDOW S 10 HOME 64-BIT-AMD RADEON R2 GRAPHICS-GRABADORA DVD No SERIE 8CC92457L6	0.00		11,125.56	0.00	11,125.56	
12413022026106	COMPUTADORA TODO EN UNO HP BUSINESS DESKTOP 205 G3-E SERIES E2-900 4GB RAM-1TB HDD-49.4 CM (19.5"), 1600X900 DE ESCRITORIO WINDOW S 10 HOME 64-BIT-AMD RADEON R2 GRAPHICS-GRABADORA DVD No SERIE 8CC92458CK	0.00		11,125.56	0.00	11,125.56	
12413022026107	COMPUTADORA TODO EN UNO HP BUSINESS DESKTOP 205 G3-E SERIES E2-900 4GB RAM-1TB HDD-49.4 CM (19.5"), 1600X900 DE ESCRITORIO WINDOW S 10 HOME 64-BIT-AMD RADEON R2 GRAPHICS-GRABADORA DVD No SERIE 8CC92458D9	0.00		11,125.56	0.00	11,125.56	
12413022026110	COMPUTADORA TODO EN UNO HP BUSINESS DESKTOP 205 G3-E SERIES E2-900 4GB RAM-1TB HDD-49.4 CM (19.5"), 1600X900 DE ESCRITORIO WINDOW S 10 HOME 64-BIT-AMD RADEON R2 GRAPHICS-GRABADORA DVD No SERIE 8CC924589Y	0.00		11,125.56	0.00	11,125.56	
12413022026109	COMPUTADORA PORTATIL APPLE MACBOOK AIR MREB2LLA 33.8CM (13.3") 2560X1600 CORE I5 8GB RAM 128GB SSD GRIS MACOS MOJAVE-INTEL UHD GRAPHI CS 617 PANTALLA RETINA No SERIE SC02XQNTJK77	0.00		25,334.41	0.00	25,334.41	
12413022026111	COMPUTADORA PORTATIL APPLE MACBOOK AIR MREB2LLA 33.8CM (13.3") 2560X1600 CORE I5 8GB RAM 128GB SSD GRIS MACOS MOJAVE-INTEL UHD GRAPHI CS 617 PANTALLA RETINA No SERIE SC02XQNTJK77	0.00		25,334.41	0.00	25,334.41	
12413022026112	COMPUTADORA PORTATIL HP 15-DA1034LA, I5- 8265U, 8GB, 1TB, 15.6 PULGADAS, WINDOWS 10 HOME, SIN UNIDAD OPTICA, No SERIE CND9323H71	0.00		11,817.91	0.00	11,817.91	
12413022026113	COMPUTADORA PORTATIL HP 15-DA1034LA, I5- 8265U, 8GB, 1TB, 15.6 PULGADAS, WINDOWS 10 HOME, SIN UNIDAD OPTICA, No SERIE CND9323H2M	0.00		11,817.91	0.00	11,817.91	
12413022026114	COMPUTADORA PORTATIL HP 15-DA1034LA, I5- 8265U, 8GB, 1TB, 15.6 PULGADAS, WINDOWS 10 HOME, SIN UNIDAD OPTICA, No SERIE CND9323H2M	0.00		11,817.91	0.00	11,817.91	
Coram/ Balanza							

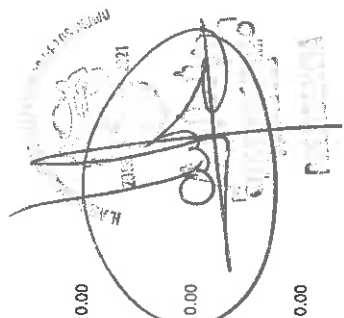

H. Ayuntamiento Municipal Constitucional de Chilpancingo, Gro.  
CONTRALORIA INTERNA MUNICIPAL



H. AYUNTAMIENTO MUNICIPAL DE CHILPANCINGO, GRO.

SECRETARIA DE FINANZAS Y ADMINISTRACION

CONSOLIDADO



BALANZA DE COMPROBACION DEL 1 DE ENERO AL 31 DE DICIEMBRE DEL 2019

C U E N T A	C O N C E P T O	SALDOS INICIALES		M O V I M I E N T O S		SALDOS ACUMULADOS	
		AL 1 DE ENERO DE 2019		ENERO - DICIEMBRE 2019		AL 31 DE DICIEMBRE DE 2019	
		DEBE	HABER	DEBE	HABER	DEBE	HABER
12413022026115	HOME, SIN UNIDAD OPTICA, No SERIE CND9323H73 COMPUTADORA PORTATIL HP 15-DA1034LA, I5-8265U, 8GB, 1TB, 15.6 PULGADAS, WINDOWS 10 HOME, SIN UNIDAD OPTICA, No SERIE	0.00		11,817.91	0.00	11,817.91	
12413022026116	COMPUTADORA PORTATIL HP 15-DA1034LA, I5-8265U, 8GB, 1TB, 15.6 PULGADAS, WINDOWS 10 HOME, SIN UNIDAD OPTICA, No SERIE	0.00		11,817.91	0.00	11,817.91	
12413022026117	COMPUTADORA PORTATIL HP 15-DA1034LA, I5-8265U, 8GB, 1TB, 15.6 PULGADAS, WINDOWS 10 HOME, SIN UNIDAD OPTICA, No SERIE	0.00		11,817.91	0.00	11,817.91	
12413022026118	COMPUTADORA PORTATIL HP 15-DA1034LA, I5-8265U, 8GB, 1TB, 15.6 PULGADAS, WINDOWS 10 HOME, SIN UNIDAD OPTICA, No SERIE	0.00		11,817.91	0.00	11,817.91	
12413022026119	COMPUTADORA PORTATIL HP 15-DA1034LA, I5-8265U, 8GB, 1TB, 15.6 PULGADAS, WINDOWS 10 HOME, SIN UNIDAD OPTICA, No SERIE	0.00		11,817.91	0.00	11,817.91	
12413022026120	COMPUTADORA PORTATIL HP 15-DA1034LA, I5-8265U, 8GB, 1TB, 15.6 PULGADAS, WINDOWS 10 HOME, SIN UNIDAD OPTICA, No SERIE	0.00		11,817.91	0.00	11,817.91	
12413022026121	COMPUTADORA PORTATIL HP 15-DA1034LA, I5-8265U, 8GB, 1TB, 15.6 PULGADAS, WINDOWS 10 HOME, SIN UNIDAD OPTICA, No SERIE	0.00		11,817.91	0.00	11,817.91	
12413022026122	COMPUTADORA PORTATIL HP 15-DA1034LA, I5-8265U, 8GB, 1TB, 15.6 PULGADAS, WINDOWS 10 HOME, SIN UNIDAD OPTICA, No SERIE	0.00		11,817.91	0.00	11,817.91	
12413022026123	LAPTOP HP 240 G7 14" INTEL CORE I5 8265U DISCO DURO 1 TB RAM 8 GB WINDOWS 10 HOME NEGRA, No SERIE 5CG9356V17	0.00		18,539.92	0.00	18,539.92	
12413022026124	LAPTOP HP 240 G7 14" INTEL CORE I5 8265U DISCO DURO 1 TB RAM 8 GB WINDOWS 10 HOME NEGRA, No SERIE 5CG9356V89	0.00		18,539.92	0.00	18,539.92	
12413022026125	PC DE ESCRITORIO DELLEMC VOSTRO DESKTOP 3470, PROCESADOR INTEL CORE I7, RAM 8 GB, DD 1TB, INTEL HD GRAPHICS, WINDOWS 40 PRO, MONITOR 19.5", No SERIE 2S18ZJ2; 68X9ZJ2	0.00		22,280.93	0.00	22,280.93	
12413022026126	ACER ASPIRE A515-51-76BP 39.6 CM (15.6") LCD-INTEL CORE I7 (7TH GEN) I7-7500 DU DUAL-CORE (2 NUCLEOS) 2.70GHZ- 12GB DDR4 SDRAM-1TB HDD-WINDOWS 10 HOME 64-BIT - 13866X768- GRIS ACERO- INTEL HD GRAPHICS 620 DDR4 SDRAM, BLUETOOTH, CAMARA FRONTAL/CAMARA WEB, IEEE 802.11AC, GIGABIT TEIHEMET, REE (RJ-45) HDMI-1 X PUERTOS USB 3.0-USB TIPO C, No SERIE NXGPAAL0017240AFC03400	0.00		18,981.60	0.00	18,981.60	

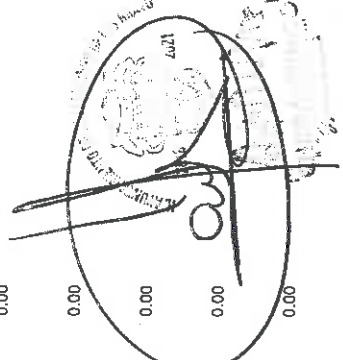
  
 SECRETARIA DE FINANZAS Y ADMINISTRACION  
 2019



H. Ayuntamiento Municipal Constitucional de Chilpancingo, Gro.  
 SECRETARIA DE FINANZAS Y ADMINISTRACION  



H. AYUNTAMIENTO MUNICIPAL DE CHILPANCINGO, GRO.

SECRETARIA DE FINANZAS Y ADMINISTRACION

CONSOLIDADO



BALANZA DE COMPROBACIÓN DEL 1 DE ENERO AL 31 DE DICIEMBRE DEL 2019

C U E N T A	C O N C E P T O	SALDOS INICIALES		MOVIMIENTOS		SALDOS ACUMULADOS	
		AL 1 DE ENERO DE 2019		ENERO - DICIEMBRE 2019		AL 31 DE DICIEMBRE DE 2019	
		DEBE	HABER	DEBE	HABER	DEBE	HABER
12413022026127	ACER ASPIRE A515-51-76BP 39.6 CM (15.6") LCD- INTEL CORE I7 (7TH GEN) I7-750 DU DUAL-CORE (2 NUCLEOS) 2.70GHZ- 12GB DDR4 SDRAM-1TB HD0- WINDOWS 10 HOME 64-BIT- 1366X768- GRIS ACERO- INTEL HD GRAPHICS 620 DDR4 SIDRAM, BLUETOOTH, CAMARA FRONTAL/CAMARA WEB, IEEE 802 11AC, GIGABIT TETHERMET, RED (RJ-45), HDMI-1 X PUERTOS USB 3.0-USB TIPO C, No SERIE NXGPAAL0017240B3D23400	0.00		18,981.60	0.00	18,981.60	
12413022026128	ACER ASPIRE A515-51-76BP 39.6 CM (15.6") LCD- INTEL CORE I7 (7TH GEN) I7-750 DU DUAL-CORE (2 NUCLEOS) 2.70GHZ- 12GB DDR4 SDRAM-1TB HD0- WINDOWS 10 HOME 64-BIT- 1366X768- GRIS ACERO- INTEL HD GRAPHICS 620 DDR4 SIDRAM, BLUETOOTH, CAMARA FRONTAL/CAMARA WEB, IEEE 802 11AC, GIGABIT TETHERMET, RED (RJ-45), HDMI-1 X PUERTOS USB 3.0-USB TIPO C, No SERIE NXGPAAL0017240B4A53400	0.00		18,981.60	0.00	18,981.60	
12413022026129	ACER ASPIRE A515-51-76BP 39.6 CM (15.6") LCD- INTEL CORE I7 (7TH GEN) I7-750 DU DUAL-CORE (2 NUCLEOS) 2.70GHZ- 12GB DDR4 SDRAM-1TB HD0- WINDOWS 10 HOME 64-BIT- 1366X768- GRIS ACERO- INTEL HD GRAPHICS 620 DDR4 SIDRAM, BLUETOOTH, CAMARA FRONTAL/CAMARA WEB, IEEE 802 11AC, GIGABIT TETHERMET, RED (RJ-45), HDMI-1 X PUERTOS USB 3.0-USB TIPO C, No SERIE NXGPAAL0017240BCDF3400	0.00		18,981.60	0.00	18,981.60	
12413022026131	ACER ASPIRE A515-51-76BP 39.6 CM (15.6") LCD- INTEL CORE I7 (7TH GEN) I7-750 DU DUAL-CORE (2 NUCLEOS) 2.70GHZ- 12GB DDR4 SDRAM-1TB HD0- WINDOWS 10 HOME 64-BIT- 1366X768- GRIS ACERO- INTEL HD GRAPHICS 620 DDR4 SIDRAM, BLUETOOTH, CAMARA FRONTAL/CAMARA WEB, IEEE 802 11AC, GIGABIT TETHERMET, RED (RJ-45), HDMI-1 X PUERTOS USB 3.0-USB TIPO C, No SERIE NXGPAAL0017240BDEA3400	0.00		18,981.60	0.00	18,981.60	
12413022026132	ACER ASPIRE A515-51-76BP 39.6 CM (15.6") LCD- INTEL CORE I7 (7TH GEN) I7-750 DU DUAL-CORE (2 NUCLEOS) 2.70GHZ- 12GB DDR4 SDRAM-1TB HD0- WINDOWS 10 HOME 64-BIT- 1366X768- GRIS ACERO- INTEL HD GRAPHICS 620 DDR4 SIDRAM, BLUETOOTH, CAMARA FRONTAL/CAMARA WEB, IEEE 802 11AC, GIGABIT TETHERMET, RED (RJ-45),	0.00		18,981.60	0.00	18,981.60	

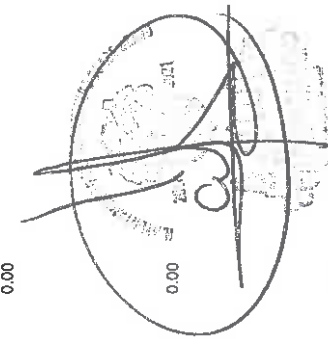

H. Ayuntamiento Municipal Constitucional de CHILPANCINGO GRO. SECRETARIA DE FINANZAS Y ADMINISTRACION



H. AYUNTAMIENTO MUNICIPAL DE CHILPANCINGO, GRO.

SECRETARIA DE FINANZAS Y ADMINISTRACION

CONSOLIDADO



BALANZA DE COMPROBACION DEL 1 DE ENERO AL 31 DE DICIEMBRE DEL 2019

C U E N T A	C O N C E P T O	SALDOS INICIALES		M O V I M I E N T O S		SALDOS ACUMULADOS	
		AL 1 DE ENERO DE 2019		ENERO - DICIEMBRE 2019		AL 31 DE DICIEMBRE DE 2019	
		DEBE	HABER	DEBE	HABER	DEBE	HABER
12413022026133	HDMI-1 X PUERTOS USB 3.0-USB TIPO C. No SERIE NXGPAAL0017240BF83400 ACER ASPIRE A515-51-76BP 39.6 CM (15.6") LCD- INTEL CORE I7 (7TH GEN) I7-750 DU DUAL-CORE (2 NUCLEOS) 2.70GHZ, 12GB DDR4, SDRAM-1TB HDD- WINDOWS 10 HOME 64-BIT - 1366X768- GRIS ACERO- INTEL HD GRAPHICS 620 DDR4 SIDRAM, BLUETOOTH, CAMARA FRONTAL/CAMARA WEB, IEEE 802 11AC, GIGABIT TETHERMET, RED (RJ-45), HDMI-1 X PUERTOS USB 3.0-USB TIPO C. No SERIE NXGPAAL001724020CD3400 MULTIFUNCIONAL EPSON L575, IMPRESORA, COPIADORA, ESCANER Y FAX, SISTEMA DE TANQUES DE TINTA, WI FI, ETHERNET, USB. No SERIE W98Y189986 MULTIFUNCIONAL EPSON L575, IMPRESORA, COPIADORA, ESCANER Y FAX, SISTEMA DE TANQUES DE TINTA, WI FI, ETHERNET, USB. No SERIE W98Y189982 MULTIFUNCIONAL EPSON L575, IMPRESORA, COPIADORA, ESCANER Y FAX, SISTEMA DE TANQUES DE TINTA, WI FI, ETHERNET, USB. No SERIE W98Y186934 ESCANER XEROX DOCUMATE 5445, ESCANER AVANZADO PARA GRUPOS DE TRABAJO DE ALTO RENDIMIENTO, 45PPM/90 IPM* (DM5445) MECANISMO CONFIABLE DE ALIMENTACION DE PAPEL CON PREVENCION CONTRA DOBLE ALIMENTACION, CAPACIDAD DE FACTORIA AUTOMATIZADA DE DOCUMENTOS, CREA ARCHIVOS PDF CON CAPACIDAD DE BUSQUEDA PARA HACER MAS FACIL LA BUSQUEDA DE DOCUMENTOS ESCANEADOS, ESCANEA INSTANTANEAMENTE CON EL TOQUE DE UN BOTON, ESCANEA LOTES DE DIFERENTES PAPELES Y TARJETAS DURAS, AHORRA ENERGIA Y UTILIZA TECNOLOGIA LED. No SERIE F8729RA1345	0.00	0.00	18,981.64	0.00	18,981.64	0.00
12413022026134	FONDO DE APORT P/FORT DE LOS MIPOS	0.00	0.00	5,916.74	0.00	5,916.74	0.00
12413022026135	EJERCICIO 2016	0.00	0.00	5,916.74	0.00	5,916.74	0.00
12413022026136	BIENES INFORMATICOS	0.00	0.00	5,916.73	0.00	5,916.73	0.00
12413022026137	EJERCICIO 2017	0.00	0.00	21,257.24	0.00	21,257.24	0.00
12413022026138	BIENES INFORMATICOS	170,376.09	0.00	0.00	0.00	170,376.09	0.00
12413022026139	COMPUTADORA LAP TOP MARCA ASUS SERIE HANOCX09X5611 CORE I5, RAM 8GB, DISCO DURO 1TB CON DISCO DURO EXTERNO SERIE 6364906487	150,888.09	0.00	0.00	0.00	150,888.09	0.00
12413022026140	FORTASEG	19,488.00	0.00	0.00	0.00	19,488.00	0.00
12413022026141	EJERCICIO 2016	19,488.00	0.00	0.00	0.00	19,488.00	0.00
12413025021		172,839.95	101,000.00	0.00	0.00	273,839.95	0.00
		108,020.80	0.00	0.00	0.00	108,020.80	0.00







H. AYUNTAMIENTO MUNICIPAL DE CHILPANCINGO, GRO.

SECRETARIA DE FINANZAS Y ADMINISTRACION

CONSOLIDADO



BALANZA DE COMPROBACION DEL 1 DE ENERO AL 31 DE DICIEMBRE DEL 2019

C U E N T A	C O N C E P T O	SALDOS INICIALES		M O V I M I E N T O S		SALDOS ACUMULADOS	
		AL 1 DE ENERO DE 2019		ENERO - DICIEMBRE 2019		AL 31 DE DICIEMBRE DE 2019	
		DEBE	HABER	DEBE	HABER	DEBE	HABER
12413025021001	BIENES INFORMATICOS	108,020.80		0.00	0.00	108,020.80	
12413025024	EJERCICIO 2018	14,120.19		0.00	0.00	14,120.19	
12413025024001	BIENES INFORMATICOS	14,120.19		0.00	0.00	14,120.19	
12413025024001001	COMPUTADORA DE ESCRITORIO MARCA HEMLETT PACKARD, MOD. 205 G2, PANTALLA 19.5", PROCESADOR AMD ET DISCO DURO 5000GB, MEMORIA RAM 4GB Y SISTEMA OPERATIVO WINDOWS 10 PRO 64	12,180.00		0.00	0.00	12,180.00	
12413025024001002	REGULADOR DE VOLTAJE 2500 VA/2000 WATTS MARCA KOBLENZ MOD. ER-2550		1,940.19	0.00	0.00		1,940.19
12413025025	EJERCICIO 2018 (NVA ADMON 2018-2021)	50,698.96		0.00	0.00	50,698.96	
12413025025001	BIENES INFORMATICOS	50,698.96		0.00	0.00	50,698.96	
12413025025001001	COMPUTADORA DE ESCRITORIO MARCA LENOVO	10,672.00		0.00	0.00	10,672.00	
12413025025001002	COMPUTADORA LAPTOP HP DISCO DURO 1TB	10,672.00		0.00	0.00	10,672.00	
12413025025001003	COMPUTADORA LAPTOP HP PROBOOK 440	10,672.00		0.00	0.00	10,672.00	
12413025025001004	DISCO DURO 1 TB	9,341.48		0.00	0.00	9,341.48	
12413025025001005	COMPUTADORA LAPTOP HP PROBOOK 440	9,341.48		0.00	0.00	9,341.48	
12413025026	EJERCICIO 2019	0.00		0.00	0.00	0.00	
12413025026001	BIENES INFORMATICOS	0.00		101,000.00	0.00	101,000.00	
12413025026001001	COMPUTADORA DE ESCRITORIO (1)	0.00		101,000.00	0.00	101,000.00	
12413025026001002	COMPUTADORA DE ESCRITORIO (2)	0.00		20,000.00	0.00	20,000.00	
12413025026001003	COMPUTADORA DE ESCRITORIO (3)	0.00		20,000.00	0.00	20,000.00	
12413025026001004	COMPUTADORA DE ESCRITORIO (4)	0.00		20,000.00	0.00	20,000.00	
12413025026001005	COMPUTADORA MULTIFUNCIONAL	0.00		21,000.00	0.00	21,000.00	
12413040	INGRESOS PROPIOS	297,488.44		319,379.24	0.00	616,867.68	
12413040025	ADMINISTRACION 2018-2021	297,488.44		0.00	0.00	297,488.44	
12413040025001	COMPUTADORA ALL IN-ONE MARCA DELL, MC-INSPIRON-AIO-347 7 23.8" INTEL CORE I7-2 T-12 GB, 100 GB WINDOWS 10	30,774.80		0.00	0.00	30,774.80	
12413040025002	COMPUTADORA ALL IN-ONE MARCA DELL, MC-INSPIRON-AIO-347 7 23.8" INTEL CORE I7-2 T-12 GB, 100 GB WINDOWS 10	30,774.80		0.00	0.00	30,774.80	
12413040025003	COMPUTADORA ALL IN-ONE MARCA DELL, MC-INSPIRON-AIO-347 7 23.8" INTEL CORE I7-2 T-12 GB, 100 GB WINDOWS 10	30,774.80		0.00	0.00	30,774.80	
12413040025004	COMPUTADORA ALL IN-ONE MARCA DELL, MC-INSPIRON-AIO-347 7 23.8" INTEL CORE I7-2 T-12 GB, 100 GB WINDOWS 10	30,774.80		0.00	0.00	30,774.80	
12413040025005	COMPUTADORA ALL IN-ONE MARCA DELL, MC-INSPIRON-AIO-347 7 23.8" INTEL CORE I7-2 T-12 GB, 100 GB WINDOWS 10	30,774.80		0.00	0.00	30,774.80	

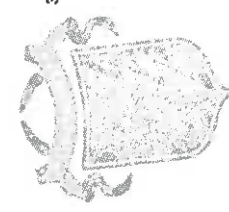
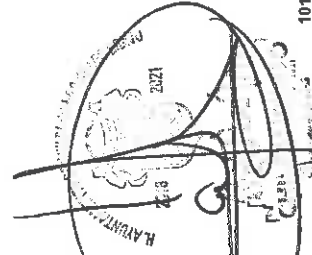

M. Ayuntamiento Chilpancingo, Gro. SECRETARIA DE FINANZAS Y ADMINISTRACION



H. AYUNTAMIENTO MUNICIPAL DE CHILPANCINGO, GRO.  
SECRETARIA DE FINANZAS Y ADMINISTRACION  
CONSOLIDADO



BALANZA DE COMPROBACIÓN DEL 1 DE ENERO AL 31 DE DICIEMBRE DEL 2019

C U E N T A	C O N C E P T O	SALDOS INICIALES		M O V I M I E N T O S		SALDOS ACUMULADOS	
		AL 1 DE ENERO DE 2019		ENERO - DICIEMBRE 2019		AL 31 DE DICIEMBRE DE 2019	
		DEBE	HABER	DEBE	HABER	DEBE	HABER
12413040025006	COMPUTADORA ALL IN-ONE MARCA HP CORE I5 8GB RAM 21" PANTALLA 22.8" WINDOWA 10	21,889.20		0.00		21,889.20	
12413040025007	COMPUTADORA ALL IN-ONE MARCA HP CORE I5 8GB RAM 21" PANTALLA 22.8" WINDOWA 10	21,889.20		0.00		21,889.20	
12413040025008	COMPUTADORA ALL IN-ONE MARCA HP CORE I5 8GB RAM 21" PANTALLA 22.8" WINDOWA 10	21,889.20		0.00		21,889.20	
12413040025009	COMPUTADORA ALL IN-ONE MARCA HP CORE I5 8GB RAM 21" PANTALLA 22.8" WINDOWA 10	21,889.20		0.00		21,889.20	
12413040025010	COMPUTADORA ALL IN-ONE MARCA HP CORE I5 8GB RAM 21" PANTALLA 22.8" WINDOWA 10	21,889.20		0.00		21,889.20	
12413040025011	LAPTOP MARCAHP MOD 240 GB PROCESADOR CORE I5 7200U, PANTALLA DE 14" MEMORIA RAM DE 8GB, DISCODURO DE 1 TB, SISTEMA OPERATIVO WIN 10 HOME 64 BITS N/S	17,084.22		0.00		17,084.22	
12413040025012	LAPTOP MARCAHP MOD 240 GB PROCESADOR CORE I5 7200U, PANTALLA DE 14" MEMORIA RAM DE 8GB, DISCODURO DE 1 TB, SISTEMA OPERATIVO WIN 10 HOME 64 BITS N/S	17,084.22		0.00		17,084.22	
12413040026	EJERCICIO 2019	0.00		319,379.24		319,379.24	
12413040026001	LAPTOP DEL INSPIRON 5570- PANTALLA DE 15.6", CORE I5-8250J, 8GB DE RAM, 2TB DE MEMORIA, WINDOWA 10 HOME (64 BITS) TECLADO NUMERICO COMPLETO N SERIE: 2758142	0.00		19,900.00		19,900.00	
12413040026002	DESKTOP TODO EN UNO HP 24-F012LA- PANTALLA DE 23.8", PROCESADO CORE I5-8250U, 8GB RAM, 2TB DE ALMACENAMIENTO, SISTEMA OPERATIVO WINDOWS 10 HOME, PUERTO USB 2.0 (2), PUERTO HDMI, BLUETOOTH, No. SERIE 8CC83500QJ	0.00		23,398.94		23,398.94	
12413040026003	DESKTOP TODO EN UNO HP 24-F012LA- PANTALLA DE 23.8", PROCESADO CORE I5-8250U, 8GB RAM, 2TB DE ALMACENAMIENTO, SISTEMA OPERATIVO WINDOWS 10 HOME, PUERTO USB 2.0 (2), PUERTO HDMI, BLUETOOTH, No. SERIE 8CC83500PN	0.00		23,398.94		23,398.94	
12413040026004	DESKTOP TODO EN UNO HP 24-F012LA- PANTALLA DE 23.8", PROCESADO CORE I5-8250U, 8GB RAM, 2TB DE ALMACENAMIENTO, SISTEMA OPERATIVO WINDOWS 10 HOME, PUERTO USB 2.0 (2), PUERTO HDMI, BLUETOOTH, No. SERIE 8CC83500QR	0.00		24,300.00		24,300.00	
12413040026005	DESKTOP TODO EN UNO HP 24-F012LA- PANTALLA DE 23.8", PROCESADO CORE I5-8250U, 8GB RAM, 2TB DE ALMACENAMIENTO, SISTEMA OPERATIVO WINDOWS 10 HOME, PUERTO USB 2.0 (2), PUERTO HDMI, BLUETOOTH, No. SERIE 8CC8412230	0.00		24,300.00		24,300.00	
12413040026006	DESKTOP TODO EN UNO HP 24-F012LA- PANTALLA DE 23.8", PROCESADO CORE I5-8250U, 8GB RAM, 2TB DE ALMACENAMIENTO, SISTEMA OPERATIVO WINDOWS 10 HOME, PUERTO USB 2.0 (2), PUERTO HDMI, BLUETOOTH, No. SERIE 8CC8412230	0.00		24,300.01		24,300.01	

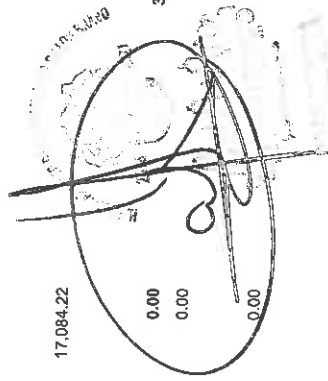

H. Ayuntamiento Municipal Constitucional de Chilpancingo, Gro. de México  
SECRETARIA DE FINANZAS Y ADMINISTRACION

2018  
M. AYUNTAMIENTO DE CHILPANCINGO  
SECRETARIA DE FINANZAS Y ADMINISTRACION  
2018



H. AYUNTAMIENTO MUNICIPAL DE CHILPANCINGO, GRO.

SECRETARIA DE FINANZAS Y ADMINISTRACION

CONSOLIDADO



BALANZA DE COMPROBACION DEL 1 DE ENERO AL 31 DE DICIEMBRE DEL 2019

C U E N T A	C O N C E P T O	SALDOS INICIALES		M O V I M I E N T O S		SALDOS ACUMULADOS	
		AL 1 DE ENERO DE 2019		ENERO - DICIEMBRE 2019		AL 31 DE DICIEMBRE DE 2019	
		DEBE	HABER	DEBE	HABER	DEBE	HABER
12413040026007	PUERTO HDMI, BLUETOOTH, No. SERIE 8CC84112253 LAPTOP HP 240 G6 14", INTEL CORE I5, 1TB, NEGRO, 1L A68LA	0.00		23,204.64	0.00	23,204.64	
12413040026008	PROYECTOR EPSON POWERLITE S39, 3300 LUMENES ANSI, 3LCD, SVGA (800X600) 10000 H, COLOR BLANCO	0.00		12,148.68	0.00	12,148.68	
12413040026009	COMPUTADORA DE ESCRITORIO ALL IN ONE DELL OPTIPLEX 3050 CORE I5 MB RAM 8 GB, HD 1 TB, PANTALLA 19.5" NP-GD6NY No. SERIE: 1XLZ0S2	0.00		22,504.00	0.00	22,504.00	
12413040026010	LAPTOP DEL VOSTRO 14 3000 SERIES 348, INTEL CORE I3 8GB, 1000 GB, 14", WINDOWS 10 PRO, INTEL HD (V3468) 3Kb81TW10P1WYN9GR) CLAVE CT: COMDLL9040 MODELO VOSTRO 124 SERIES 34 68	0.00		16,923.99	0.00	16,923.99	
12413040026011	COMPUTADORA NOTEBOOK DELL INSPIRON 5567 CORE I5 RAM 8GB HD 1TB No SERIE 3YK7RC2	0.00		14,000.00	0.00	14,000.00	
12413040026012	COMPUTADORAS NOTEBOOK DELL INSPIRON 5567 CORE I5 RAM 8GB HD 1TB No SERIE 79H6RC2	0.00		14,000.00	0.00	14,000.00	
12413040026014	COMPUTADORA NOTEBOOK DELL INSPIRON 7359 CORE I5 RAM 8GB HD 1TB No SERIE 2DVH782	0.00		19,000.01	0.00	13,000.01	
12413040026015	COMPUTADORA NOTEBOOK DELL INSPIRON 7359 CORE I5 RAM 8GB HD 1TB No SERIE 52TH782	0.00		13,000.01	0.00	13,000.01	
12413040026016	COMPUTADORA NOTEBOOK DELL INSPIRON 3467 CORE I5 7200J RAM 8GB HD 1 TB PANTALLA 14" No SERIE: HMJW0P2	0.00		14,000.00	0.00	14,000.00	
12413040026017	COMPUTADORA NOTEBOOK DELL INSPIRON 3467 CORE I5 7200J RAM 8GB HD 1 TB PANTALLA 14" No SERIE: FMJW0P2	0.00		14,000.00	0.00	14,000.00	
12413040026018	COMPUTADORES DE ESCRITORIO ENSAMBLADA - MONITOR HP MOD V190 No SERIE 1CR84115F59, TECLADO LOGITECH MK220 No DE SERIE 1837SC104L89, PROCESADOR CORE I5 No DE SERIE U8LX725600017, MEMORIA RAM 8GB ADATA No SERIE 4712366966444, MOTHERBOARD GIGABYTE No DE SERIE 183250083150, DISCO DURO DE 1TRB No DE SERIE ZMT054ZE, UNIDAD DE DVD No DE SERIE 374352472E882502782	0.00		11,500.01	0.00	11,500.01	
12413040026018	COMPUTADORES DE ESCRITORIO ENSAMBLADA - MONITOR HP MOD V190 No SERIE 1CR84115F55,	0.00		11,500.01	0.00	11,500.01	

SECRETARIA DE FINANZAS Y ADMINISTRACION  
CHILPANCINGO, GRO.  
2019



H. Ayuntamiento Municipal Constitucional 6º  
CENTRO DE ATENCION AL CIUDADANO MUNICIPAL



H. AYUNTAMIENTO MUNICIPAL DE CHILPANCINGO, GRO.

SECRETARIA DE FINANZAS Y ADMINISTRACION

CONSOLIDADO



BALANZA DE COMPROBACIÓN DEL 1 DE ENERO AL 31 DE DICIEMBRE DEL 2019

C U E N T A	C O N C E P T O	SALDOS INICIALES		MOVIMIENTOS		SALDOS ACUMULADOS	
		AL 1 DE ENERO DE 2019		ENERO - DICIEMBRE 2019		AL 31 DE DICIEMBRE DE 2019	
		DEBE	HABER	DEBE	HABER	DEBE	HABER
12414	TECLADO LOGITECH MK220 No DE SERIE 18375C104LC9, PROCESADOR CORE I5 No DE SERIE U8BK424100482, MEMORIA RAM 8GB ADATA No SERIE 4712366966444, MOTHERBOARD GIGABYTE No DE SERIE 183250083149, DISCO DURO DE 1TRB No DE SERIE ZN10TJK6, UNIDAD DE DVD No DE SERIE 37435247282H8822505 OTROS MOBILIARIOS Y EQUIPOS DE ADMINISTRACION	11,983.84		0.00		11,983.84	
12414001	GASTO CORRIENTE	11,983.84		0.00		11,983.84	
12414001005	ADMON 2012 - 2015	11,983.84		0.00		11,983.84	
12414001005001	OTROS MOBILIARIOS Y EQUIPOS DE ADMINISTRACION	11,983.84		0.00		11,983.84	
12419	OTROS MOBILIARIOS Y EQUIPOS DE ADMINISTRACION	132,722.66		0.00		132,722.66	
12419021	GASTO CORRIENTE	132,722.66		0.00		132,722.66	
12419021020	ADMON 2015 - 2018	56,902.77		0.00		56,902.77	
12419021020001	EQUIPO DE ADMINISTRACION	56,902.77		0.00		56,902.77	
12419021021	EJERCICIO 2016	75,819.89		0.00		75,819.89	
12419021021001	EQUIPO DE ADMINISTRACION	75,819.89		0.00		75,819.89	
1242	MOBILIARIO Y EQUIPO EDUCACIONAL Y RECREATIVO	75,819.89		0.00		75,819.89	
12421	EQUIPOS Y APARATOS AUDIOVISUALES	3,313,927.51		232,849.25		3,546,776.76	
12421001	GASTO CORRIENTE	354,518.99		0.00		354,518.99	
12421001004	ADMON 2009 - 2012	271,292.75		0.00		271,292.75	
12421001004001	EQUIPO Y APARATOS AUDIOVISUALES	271,292.75		0.00		271,292.75	
12421002	FONDO DE APORT P/INFRA SOC MPAL	271,292.75		0.00		271,292.75	
12421002004	ADMON 2012 - 2015	14,130.00		0.00		14,130.00	
12421002004001	EQUIPOS Y APARATOS AUDIOVISUALES	14,130.00		0.00		14,130.00	
12421021	GASTO CORRIENTE	69,096.24		0.00		69,096.24	
12421021021	EJERCICIO 2016	69,096.24		0.00		69,096.24	
12421021021001	EQUIPOS Y APARATOS AUDIOVISUALES	69,096.24		0.00		69,096.24	
12423	CÁMARAS FCTOGRAFICAS Y DE VIDEO	2,517,833.10		232,849.25		2,750,682.35	
12423001	GASTO CORRIENTE	233,779.85		0.00		233,779.85	
12423001004	ADMON 2009 - 2012	233,779.85		0.00		233,779.85	
12423001004001	CAMARAS FOTOGRAFICAS Y DE VIDEO	233,779.85		0.00		233,779.85	
12423002	FONDO DE APORT P/INFRA SOC MPAL	36,034.84		0.00		36,034.84	
12423002005	ADMON 2012 - 2015	36,034.84		0.00		36,034.84	
12423002005001	CAMARAS FOTOGRAFICAS Y DE VIDEO	36,034.84		0.00		36,034.84	

2019

*[Firma manuscrita]*

2019

*[Firma manuscrita]*

232,849.25

*[Firma manuscrita]*

232,849.25

H. Ayuntamiento Municipal Constitucional de Chilpancingo, Gro.  
CONTRALORIA MUNICIPAL

*[Firma manuscrita]*



H. AYUNTAMIENTO MUNICIPAL DE CHILPANCINGO, GRO.

SECRETARIA DE FINANZAS Y ADMINISTRACION

CONSOLIDADO



BALANZA DE COMPROBACION DEL 1 DE ENERO AL 31 DE DICIEMBRE DEL 2019

C U E N T A	C O N C E P T O	SALDOS INICIALES		M O V I M I E N T O S		SALDOS ACUMULADOS	
		AL 1 DE ENERO DE 2019		ENERO - DICIEMBRE 2019		AL 31 DE DICIEMBRE DE 2019	
		DEBE	HABER	DEBE	HABER	DEBE	HABER
12423003	FONDO DE APORT PFIORT DE LOS NIPIOS	96,782.65		0.00		96,782.65	
12423003005	ADMON 2012-2015	96,782.65		0.00		96,782.65	
12423003005001	CAMARAS FOTOGRAFICAS Y VIDEO	96,782.65		0.00		96,782.65	
12423021	GASTO CORRIENTE	220,446.80		0.00		220,446.80	
12423021020	ADMON 2015 - 2018	45,936.29		0.00		45,936.29	
12423021020001	CAMARAS FOTOGRAFICAS Y DE VIDEO	45,936.29		0.00		45,936.29	
12423021021	EJERCICIO 2016	106,141.82		0.00		106,141.82	
12423021021001	CAMARAS FOTOGRAFICAS Y DE VIDEO	106,141.82		0.00		106,141.82	
12423021022	EJERCICIO 2017	59,729.41		0.00		59,729.41	
12423021022001	CAMARAS FOTOGRAFICAS Y DE VIDEO	59,729.41		0.00		59,729.41	
12423021022001001	CAMARAS FOTOGRAFICAS Y DE VIDEO	3,977.14		0.00		3,977.14	
12423021022001002	CAMARA FOTOGRAFICA DIGITAL CANON						
12423021022001003	POWERSHOT ELPH160 20.0 MEGAPIXELES, 8X OPTICAL/AX.DIGITAL ZOOM, 2.7" TFL-LCD, 720P HIGH DEFINITION VIDEO RECORDING, DIGIC 4-HIMAGEN PSELPH160 (SL)						
12423021022001004	CAMARA FOTOGRAFICA KIT 80 D, 18-55MM KIT DE LIMPIEZA PARA LENTES DE CAMARA FOTOGRAFICA T6 LENTESS IM						
12423021022001005	CAMARA FOTOGRAFICA REBEL T6 E VIDEO CAMARA VIXIA H87						
12423021022001006	EJERCICIO 2018	11,856.73		0.00		11,856.73	
12423021022001007	CAMARAS FOTOGRAFICAS Y EQUIPO DE VIDEO	7,649.36		0.00		7,649.36	
12423021022001008	VIDEOCAMARAVIXIA HF R82 MARCA CANON MOD. 1968C002AA	8,639.28		0.00		8,639.28	
12423021022001009	FONDO DE APORTACIONES PARA LA INFRAESTRUCTURA SOCIAL MUNICIPAL	8,639.28		0.00		8,639.28	
12423022	EJERCICIO 2016	144,048.60		0.00		144,048.60	
12423022021	CAMARAS FCTOGRAFICAS Y DE VIDEO	35,904.60		0.00		35,904.60	
12423022021001	EJERCICIO 2017	35,904.60		0.00		35,904.60	
12423022022	CAMARAS FOTOGRAFICAS , DE VIDEO Y DE PROYECCION	8,500.00		0.00		8,500.00	
12423022022001	PROYECTOR BENQ 527	8,500.00		0.00		8,500.00	
12423022022001001	EJERCICIO 2018	99,644.00		0.00		99,644.00	
12423022022001002	CAMARAS FOTOGRAFICAS , DE VIDEO Y DE PROYECCION	99,644.00		0.00		99,644.00	
12423022022001003	CAMARA CYBER SHOT DSC HX400	24,940.00		0.00		24,940.00	
12423022022001004	CAMARA CYBER SHOT DSC HX400	24,940.00		0.00		24,940.00	
12423022022001005	CAMARA CANON POWER SHOT ELPH180	16,588.00		0.00		16,588.00	
12423022022001006	CAMARA CANON POWER SHOT ELPH180	16,588.00		0.00		16,588.00	

SECRETARIA DE FINANZAS Y ADMINISTRACION

H. Ayuntamiento Municipal Constitucional de  
 CHILPANCINGO, GRO.  
 CONT. LOBIA INTERNA MUNICIPAL





H. AYUNTAMIENTO MUNICIPAL DE CHILPANCINGO, GRO.

SECRETARIA DE FINANZAS Y ADMINISTRACION

CONSOLIDADO



BALANZA DE COMPROBACIÓN DEL 1 DE ENERO AL 31 DE DICIEMBRE DEL 2019

C U E N T A	C O N C E P T O	SALDOS INICIALES		MOVIMIENTOS		SALDOS ACUMULADOS	
		AL 1 DE ENERO DE 2019		ENERO - DICIEMBRE 2019		AL 31 DE DICIEMBRE DE 2019	
		DEBE	HABER	DEBE	HABER	DEBE	HABER
12423022024001005	CAMARA CANON POWER SHOT ELPH180	16,588.00		0.00	0.00	16,588.00	
12423023	FONDO DE APORT P/FORT DE LOS MPIO	36,740.36		0.00	0.00	36,740.36	
12423023021	EJERCICIO 2016	36,740.36		0.00	0.00	36,740.36	
12423023021001	CAMARAS FOTOGRAFICAS Y DE VIDEO	36,740.36		0.00	0.00	36,740.36	
12423025	FORTASEG	1,750,000.00		200,000.00	0.00	1,950,000.00	
12423025021	EJERCICIO 2016	1,150,000.00		0.00	0.00	1,150,000.00	
12423025021002	CAMARA FOTOGRAFICA DE OPERACION PARA 1ER RESPONDIENTE	1,150,000.00		0.00	0.00	1,150,000.00	
12423025022	EJERCICIO 2017	600,000.00		0.00	0.00	600,000.00	
12423025022001	CAMARAS DE SOLAPA	600,000.00		0.00	0.00	600,000.00	
12423025022001001	CAMARAS DE SOLAPACAMARA DE SOLAPA MARCA HIKVISION, MEMORIA 32GB, TRANSMISION 4G O WIFI, VISION NOCTURNA, FOTOGRAFIAS DE 16MP, GPS INTERCONSTRUIDO Y BATERIA 4400MAH.	10,000.00		0.00	0.00	10,000.00	
12423025022001002	CAMARAS DE SOLAPACAMARA DE SOLAPA MARCA HIKVISION, MEMORIA 32GB, TRANSMISION 4G O WIFI, VISION NOCTURNA, FOTOGRAFIAS DE 16MP, GPS INTERCONSTRUIDO Y BATERIA 4400MAH.	10,000.00		0.00	0.00	10,000.00	
12423025022001003	CAMARAS DE SOLAPACAMARA DE SOLAPA MARCA HIKVISION, MEMORIA 32GB, TRANSMISION 4G O WIFI, VISION NOCTURNA, FOTOGRAFIAS DE 16MP, GPS INTERCONSTRUIDO Y BATERIA 4400MAH.	10,000.00		0.00	0.00	10,000.00	
12423025022001004	CAMARAS DE SOLAPACAMARA DE SOLAPA MARCA HIKVISION, MEMORIA 32GB, TRANSMISION 4G O WIFI, VISION NOCTURNA, FOTOGRAFIAS DE 16MP, GPS INTERCONSTRUIDO Y BATERIA 4400MAH.	10,000.00		0.00	0.00	10,000.00	
12423025022001005	CAMARAS DE SOLAPACAMARA DE SOLAPA MARCA HIKVISION, MEMORIA 32GB, TRANSMISION 4G O WIFI, VISION NOCTURNA, FOTOGRAFIAS DE 16MP, GPS INTERCONSTRUIDO Y BATERIA 4400MAH.	10,000.00		0.00	0.00	10,000.00	
12423025022001006	CAMARAS DE SOLAPACAMARA DE SOLAPA MARCA HIKVISION, MEMORIA 32GB, TRANSMISION 4G O WIFI, VISION NOCTURNA, FOTOGRAFIAS DE 16MP, GPS INTERCONSTRUIDO Y BATERIA 4400MAH.	10,000.00		0.00	0.00	10,000.00	
12423025022001007	CAMARAS DE SOLAPACAMARA DE SOLAPA MARCA HIKVISION, MEMORIA 32GB, TRANSMISION 4G O WIFI, VISION NOCTURNA, FOTOGRAFIAS DE 16MP, GPS INTERCONSTRUIDO Y BATERIA 4400MAH.	10,000.00		0.00	0.00	10,000.00	
12423025022001008	CAMARAS DE SOLAPACAMARA DE SOLAPA MARCA HIKVISION, MEMORIA 32GB, TRANSMISION 4G O WIFI, VISION NOCTURNA, FOTOGRAFIAS DE 16MP, GPS INTERCONSTRUIDO Y BATERIA 4400MAH.	10,000.00		0.00	0.00	10,000.00	

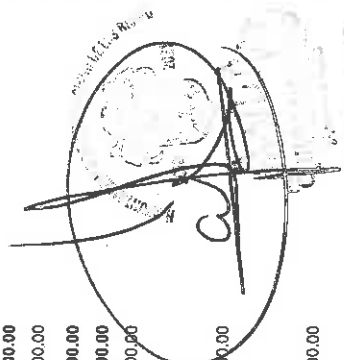
  
 H. Ayuntamiento Municipal - Constitucional de Chilpancingo, Gro.  
 CONTADOR GENERAL MUNICIPAL





H. AYUNTAMIENTO MUNICIPAL DE CHILPANCINGO, GRO.

SECRETARIA DE FINANZAS Y ADMINISTRACION

CONSOLIDADO



BALANZA DE COMPROBACION DEL 1 DE ENERO AL 31 DE DICIEMBRE DEL 2019

C U E N T A	C O N C E P T O	SALDOS INICIALES		MOVIMIENTOS		SALDOS ACUMULADOS	
		AL 1 DE ENERO DE 2019		ENERO - DICIEMBRE 2019		AL 31 DE DICIEMBRE DE 2019	
		DEBE	HABER	DEBE	HABER	DEBE	HABER
1 2 4 2 3 025 022 001 009	16MP, GPS INTERCONSTRUIDO Y BATERIA 4400MAH. CAMARAS DE SOLAPACAMARA DE SOLAPA MARCA HIKVISION, MEMORIA 32GB, TRANSMISION 4G O WIFI, VISION NOCTURNA, FOTOGRAFIAS DE 16MP, GPS INTERCONSTRUIDO Y BATERIA 4400MAH.	10,000.00		0.00	0.00	10,000.00	
1 2 4 2 3 025 022 001 010	CAMARAS DE SOLAPACAMARA DE SOLAPA MARCA HIKVISION, MEMORIA 32GB, TRANSMISION 4G O WIFI, VISION NOCTURNA, FOTOGRAFIAS DE 16MP, GPS INTERCONSTRUIDO Y BATERIA 4400MAH.	10,000.00		0.00	0.00	10,000.00	
1 2 4 2 3 025 022 001 011	CAMARAS DE SOLAPACAMARA DE SOLAPA MARCA HIKVISION, MEMORIA 32GB, TRANSMISION 4G O WIFI, VISION NOCTURNA, FOTOGRAFIAS DE 16MP, GPS INTERCONSTRUIDO Y BATERIA 4400MAH.	10,000.00		0.00	0.00	10,000.00	
1 2 4 2 3 025 022 001 012	CAMARAS DE SOLAPACAMARA DE SOLAPA MARCA HIKVISION, MEMORIA 32GB, TRANSMISION 4G O WIFI, VISION NOCTURNA, FOTOGRAFIAS DE 16MP, GPS INTERCONSTRUIDO Y BATERIA 4400MAH.	10,000.00		0.00	0.00	10,000.00	
1 2 4 2 3 025 022 001 013	CAMARAS DE SOLAPACAMARA DE SOLAPA MARCA HIKVISION, MEMORIA 32GB, TRANSMISION 4G O WIFI, VISION NOCTURNA, FOTOGRAFIAS DE 16MP, GPS INTERCONSTRUIDO Y BATERIA 4400MAH.	10,000.00		0.00	0.00	10,000.00	
1 2 4 2 3 025 022 001 014	CAMARAS DE SOLAPACAMARA DE SOLAPA MARCA HIKVISION, MEMORIA 32GB, TRANSMISION 4G O WIFI, VISION NOCTURNA, FOTOGRAFIAS DE 16MP, GPS INTERCONSTRUIDO Y BATERIA 4400MAH.	10,000.00		0.00	0.00	10,000.00	
1 2 4 2 3 025 022 001 015	CAMARAS DE SOLAPACAMARA DE SOLAPA MARCA HIKVISION, MEMORIA 32GB, TRANSMISION 4G O WIFI, VISION NOCTURNA, FOTOGRAFIAS DE 16MP, GPS INTERCONSTRUIDO Y BATERIA 4400MAH.	10,000.00		0.00	0.00	10,000.00	
1 2 4 2 3 025 022 001 016	CAMARAS DE SOLAPACAMARA DE SOLAPA MARCA HIKVISION, MEMORIA 32GB, TRANSMISION 4G O WIFI, VISION NOCTURNA, FOTOGRAFIAS DE 16MP, GPS INTERCONSTRUIDO Y BATERIA 4400MAH.	10,000.00		0.00	0.00	10,000.00	
1 2 4 2 3 025 022 001 017	CAMARAS DE SOLAPACAMARA DE SOLAPA MARCA HIKVISION, MEMORIA 32GB, TRANSMISION 4G O WIFI, VISION NOCTURNA, FOTOGRAFIAS DE 16MP, GPS INTERCONSTRUIDO Y BATERIA 4400MAH.	10,000.00		0.00	0.00	10,000.00	
1 2 4 2 3 025 022 001 018	CAMARAS DE SOLAPACAMARA DE SOLAPA MARCA HIKVISION, MEMORIA 32GB, TRANSMISION 4G O WIFI, VISION NOCTURNA, FOTOGRAFIAS DE 16MP, GPS INTERCONSTRUIDO Y BATERIA 4400MAH.	10,000.00		0.00	0.00	10,000.00	
1 2 4 2 3 025 022 001 019	CAMARAS DE SOLAPACAMARA DE SOLAPA	10,000.00		0.00	0.00	10,000.00	

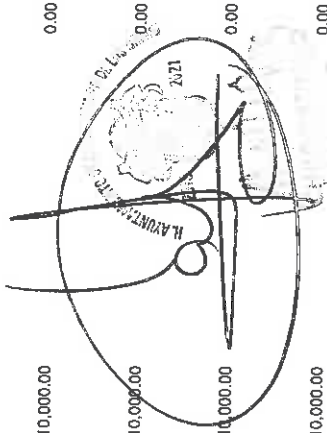

H. Ayuntamiento Municipal Constitucional de  
Chilpancingo, Gro.  
CONTRALORIA INTERNA MUNICIPAL



H. AYUNTAMIENTO MUNICIPAL DE CHILPANCINGO, GRO.

SECRETARIA DE FINANZAS Y ADMINISTRACION

CONSOLIDADO



BALANZA DE COMPROBACIÓN DEL 1 DE ENERO AL 31 DE DICIEMBRE DEL 2019

C U E N T A	C O N C E P T O	SALDOS INICIALES		MOVIMIENTOS		SALDOS ACUMULADOS	
		AL 1 DE ENERO DE 2019		ENERO - DICIEMBRE 2019		AL 31 DE DICIEMBRE DE 2019	
		DEBE	HABER	DEBE	HABER	DEBE	HABER
1 2 4 2 3 025 022 001 020	MARCA HIKVISION, MEMORIA 32GB, TRANSMISION 4G O WIFI, VISION NOCTURNA, FOTOGRAFÍAS DE 16MP, GPS INTERCONSTRUIDO Y BATERIA 4400MAH. CAMARAS DE SOLAPACAMARA DE SOLAPA	10,000.00		0.00	0.00	10,000.00	
1 2 4 2 3 025 022 001 021	MARCA HIKVISION, MEMORIA 32GB, TRANSMISION 4G O WIFI, VISION NOCTURNA, FOTOGRAFÍAS DE 16MP, GPS INTERCONSTRUIDO Y BATERIA 4400MAH. CAMARAS DE SOLAPACAMARA DE SOLAPA	10,000.00		0.00	0.00	10,000.00	
1 2 4 2 3 025 022 001 022	MARCA HIKVISION, MEMORIA 32GB, TRANSMISION 4G O WIFI, VISION NOCTURNA, FOTOGRAFÍAS DE 16MP, GPS INTERCONSTRUIDO Y BATERIA 4400MAH. CAMARAS DE SOLAPACAMARA DE SOLAPA	10,000.00		0.00	0.00	10,000.00	
1 2 4 2 3 025 022 001 023	MARCA HIKVISION, MEMORIA 32GB, TRANSMISION 4G O WIFI, VISION NOCTURNA, FOTOGRAFÍAS DE 16MP, GPS INTERCONSTRUIDO Y BATERIA 4400MAH. CAMARAS DE SOLAPACAMARA DE SOLAPA	10,000.00		0.00	0.00	10,000.00	
1 2 4 2 3 025 022 001 024	MARCA HIKVISION, MEMORIA 32GB, TRANSMISION 4G O WIFI, VISION NOCTURNA, FOTOGRAFÍAS DE 16MP, GPS INTERCONSTRUIDO Y BATERIA 4400MAH. CAMARAS DE SOLAPACAMARA DE SOLAPA	10,000.00		0.00	0.00	10,000.00	
1 2 4 2 3 025 022 001 025	MARCA HIKVISION, MEMORIA 32GB, TRANSMISION 4G O WIFI, VISION NOCTURNA, FOTOGRAFÍAS DE 16MP, GPS INTERCONSTRUIDO Y BATERIA 4400MAH. CAMARAS DE SOLAPACAMARA DE SOLAPA	10,000.00		0.00	0.00	10,000.00	
1 2 4 2 3 025 022 001 026	MARCA HIKVISION, MEMORIA 32GB, TRANSMISION 4G O WIFI, VISION NOCTURNA, FOTOGRAFÍAS DE 16MP, GPS INTERCONSTRUIDO Y BATERIA 4400MAH. CAMARAS DE SOLAPACAMARA DE SOLAPA	10,000.00		0.00	0.00	10,000.00	
1 2 4 2 3 025 022 001 027	MARCA HIKVISION, MEMORIA 32GB, TRANSMISION 4G O WIFI, VISION NOCTURNA, FOTOGRAFÍAS DE 16MP, GPS INTERCONSTRUIDO Y BATERIA 4400MAH. CAMARAS DE SOLAPACAMARA DE SOLAPA	10,000.00		0.00	0.00	10,000.00	
1 2 4 2 3 025 022 001 028	MARCA HIKVISION, MEMORIA 32GB, TRANSMISION 4G O WIFI, VISION NOCTURNA, FOTOGRAFÍAS DE 16MP, GPS INTERCONSTRUIDO Y BATERIA 4400MAH. CAMARAS DE SOLAPACAMARA DE SOLAPA	10,000.00		0.00	0.00	10,000.00	
1 2 4 2 3 025 022 001 029	MARCA HIKVISION, MEMORIA 32GB, TRANSMISION 4G O WIFI, VISION NOCTURNA, FOTOGRAFÍAS DE 16MP, GPS INTERCONSTRUIDO Y BATERIA 4400MAH. CAMARAS DE SOLAPACAMARA DE SOLAPA	10,000.00		0.00	0.00	10,000.00	

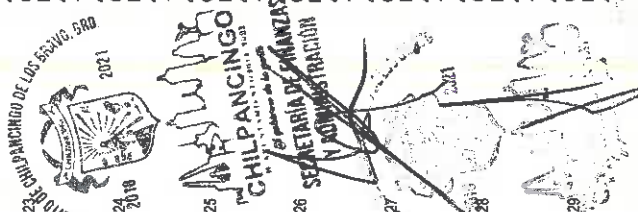
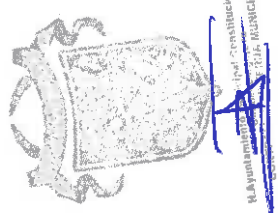
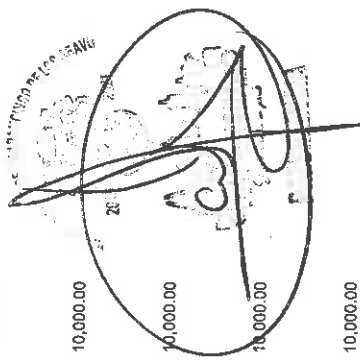



H. AYUNTAMIENTO MUNICIPAL DE CHILPANCINGO, GRO.

SECRETARIA DE FINANZAS Y ADMINISTRACION

CONSOLIDADO



BALANZA DE COMPROBACIÓN DEL 1 DE ENERO AL 31 DE DICIEMBRE DEL 2019

C U E N T A	C O N C E P T O	SALDOS INICIALES		M O V I M I E N T O S		SALDOS ACUMULADOS	
		AL 1 DE ENERO DE 2019		ENERO - DICIEMBRE 2019		AL 31 DE DICIEMBRE DE 2019	
		DEBE	HABER	DEBE	HABER	DEBE	HABER
12423025022001030	4400MAH. CAMARAS DE SOLAPACAMARA DE SOLAPA MARCA HIKVISION, MEMORIA 32GB, TRANSMISION 4G O WIFI, VISION NOCTURNA, FOTOGRAFIAS DE 16MP, GPS INTERCONSTRUIDO Y BATERIA 4400MAH.	10,000.00		0.00	0.00	10,000.00	
12423025022001031	CAMARAS DE SOLAPACAMARA DE SOLAPA MARCA HIKVISION, MEMORIA 32GB, TRANSMISION 4G O WIFI, VISION NOCTURNA, FOTOGRAFIAS DE 16MP, GPS INTERCONSTRUIDO Y BATERIA 4400MAH.	10,000.00		0.00	0.00	10,000.00	
12423025022001032	CAMARAS DE SOLAPACAMARA DE SOLAPA MARCA HIKVISION, MEMORIA 32GB, TRANSMISION 4G O WIFI, VISION NOCTURNA, FOTOGRAFIAS DE 16MP, GPS INTERCONSTRUIDO Y BATERIA 4400MAH.	10,000.00		0.00	0.00	10,000.00	
12423025022001033	CAMARAS DE SOLAPACAMARA DE SOLAPA MARCA HIKVISION, MEMORIA 32GB, TRANSMISION 4G O WIFI, VISION NOCTURNA, FOTOGRAFIAS DE 16MP, GPS INTERCONSTRUIDO Y BATERIA 4400MAH.	10,000.00		0.00	0.00	10,000.00	
12423025022001034	CAMARAS DE SOLAPACAMARA DE SOLAPA MARCA HIKVISION, MEMORIA 32GB, TRANSMISION 4G O WIFI, VISION NOCTURNA, FOTOGRAFIAS DE 16MP, GPS INTERCONSTRUIDO Y BATERIA 4400MAH.	10,000.00		0.00	0.00	10,000.00	
12423025022001035	CAMARAS DE SOLAPACAMARA DE SOLAPA MARCA HIKVISION, MEMORIA 32GB, TRANSMISION 4G O WIFI, VISION NOCTURNA, FOTOGRAFIAS DE 16MP, GPS INTERCONSTRUIDO Y BATERIA 4400MAH.	10,000.00		0.00	0.00	10,000.00	
12423025022001036	CAMARAS DE SOLAPACAMARA DE SOLAPA MARCA HIKVISION, MEMORIA 32GB, TRANSMISION 4G O WIFI, VISION NOCTURNA, FOTOGRAFIAS DE 16MP, GPS INTERCONSTRUIDO Y BATERIA 4400MAH.	10,000.00		0.00	0.00	10,000.00	
12423025022001037	CAMARAS DE SOLAPACAMARA DE SOLAPA MARCA HIKVISION, MEMORIA 32GB, TRANSMISION 4G O WIFI, VISION NOCTURNA, FOTOGRAFIAS DE 16MP, GPS INTERCONSTRUIDO Y BATERIA 4400MAH.	10,000.00		0.00	0.00	10,000.00	
12423025022001038	CAMARAS DE SOLAPACAMARA DE SOLAPA MARCA HIKVISION, MEMORIA 32GB, TRANSMISION 4G O WIFI, VISION NOCTURNA, FOTOGRAFIAS DE 16MP, GPS INTERCONSTRUIDO Y BATERIA 4400MAH.	10,000.00		0.00	0.00	10,000.00	
12423025022001040	CAMARAS DE SOLAPACAMARA DE SOLAPA	10,000.00		0.00	0.00	10,000.00	
Coram/ Balanza							

SECRETARIA DE FINANZAS Y ADMINISTRACION  
 CHILPANCINGO  
 6.08.08 PM  
 miércoles 25 marzo 2020



H. AYUNTAMIENTO MUNICIPAL DE CHILPANCINGO, GRO.

SECRETARIA DE FINANZAS Y ADMINISTRACION

CONSOLIDADO



BALANZA DE COMPROBACION DEL 1 DE ENERO AL 31 DE DICIEMBRE DEL 2019

CUENTA	CONCEPTO	SALDOS INICIALES		MOVIMIENTOS		SALDOS ACUMULADOS	
		AL 1 DE ENERO DE 2019		ENERO - DICIEMBRE 2019		AL 31 DE DICIEMBRE DE 2019	
		DEBE	HABER	DEBE	HABER	DEBE	HABER
12423025022001041	MARCA HIKVISION, MEMORIA 32GB, TRANSMISION 4G O WIFI, VISION NOCTURNA, FOTOGRAFIAS DE 16MP, GPS INTERCONSTRUIDO Y BATERIA 4400MAH. CAMARAS DE SOLAPACAMARA DE SOLAPA	10,000.00		0.00		10,000.00	
12423025022001042	MARCA HIKVISION, MEMORIA 32GB, TRANSMISION 4G O WIFI, VISION NOCTURNA, FOTOGRAFIAS DE 16MP, GPS INTERCONSTRUIDO Y BATERIA 4400MAH. CAMARAS DE SOLAPACAMARA DE SOLAPA	10,000.00		0.00		10,000.00	
12423025022001043	MARCA HIKVISION, MEMORIA 32GB, TRANSMISION 4G O WIFI, VISION NOCTURNA, FOTOGRAFIAS DE 16MP, GPS INTERCONSTRUIDO Y BATERIA 4400MAH. CAMARAS DE SOLAPACAMARA DE SOLAPA	10,000.00		0.00		10,000.00	
12423025022001044	MARCA HIKVISION, MEMORIA 32GB, TRANSMISION 4G O WIFI, VISION NOCTURNA, FOTOGRAFIAS DE 16MP, GPS INTERCONSTRUIDO Y BATERIA 4400MAH. CAMARAS DE SOLAPACAMARA DE SOLAPA	10,000.00		0.00		10,000.00	
12423025022001045	MARCA HIKVISION, MEMORIA 32GB, TRANSMISION 4G O WIFI, VISION NOCTURNA, FOTOGRAFIAS DE 16MP, GPS INTERCONSTRUIDO Y BATERIA 4400MAH. CAMARAS DE SOLAPACAMARA DE SOLAPA	10,000.00		0.00		10,000.00	
12423025022001046	MARCA HIKVISION, MEMORIA 32GB, TRANSMISION 4G O WIFI, VISION NOCTURNA, FOTOGRAFIAS DE 16MP, GPS INTERCONSTRUIDO Y BATERIA 4400MAH. CAMARAS DE SOLAPACAMARA DE SOLAPA	10,000.00		0.00		10,000.00	
12423025022001047	MARCA HIKVISION, MEMORIA 32GB, TRANSMISION 4G O WIFI, VISION NOCTURNA, FOTOGRAFIAS DE 16MP, GPS INTERCONSTRUIDO Y BATERIA 4400MAH. CAMARAS DE SOLAPACAMARA DE SOLAPA	10,000.00		0.00		10,000.00	
12423025022001048	MARCA HIKVISION, MEMORIA 32GB, TRANSMISION 4G O WIFI, VISION NOCTURNA, FOTOGRAFIAS DE 16MP, GPS INTERCONSTRUIDO Y BATERIA 4400MAH. CAMARAS DE SOLAPACAMARA DE SOLAPA	10,000.00		0.00		10,000.00	
12423025022001049	MARCA HIKVISION, MEMORIA 32GB, TRANSMISION 4G O WIFI, VISION NOCTURNA, FOTOGRAFIAS DE 16MP, GPS INTERCONSTRUIDO Y BATERIA 4400MAH. CAMARAS DE SOLAPACAMARA DE SOLAPA	10,000.00		0.00		10,000.00	
12423025022001050	MARCA HIKVISION, MEMORIA 32GB, TRANSMISION 4G O WIFI, VISION NOCTURNA, FOTOGRAFIAS DE 16MP, GPS INTERCONSTRUIDO Y BATERIA 4400MAH. CAMARAS DE SOLAPACAMARA DE SOLAPA	10,000.00		0.00		10,000.00	

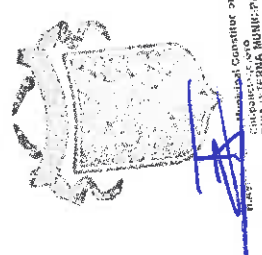
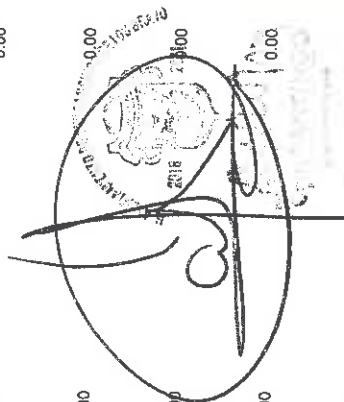





H. AYUNTAMIENTO MUNICIPAL DE CHILPANCINGO, GRO.

SECRETARIA DE FINANZAS Y ADMINISTRACION

CONSOLIDADO



BALANZA DE COMPROBACION DEL 1 DE ENERO AL 31 DE DICIEMBRE DEL 2019

C U E N T A	C O N C E P T O	SALDOS INICIALES		MOVIMIENTOS		SALDOS ACUMULADOS	
		AL 1 DE ENERO DE 2019		ENERO - DICIEMBRE 2019		AL 31 DE DICIEMBRE DE 2019	
		DEBE	HABER	DEBE	HABER	DEBE	HABER
1 2 4 2 3 025 022 001 051	4400MAH. CAMARAS DE SOLAPACAMARA DE SOLAPA MARCA HIKVISION, MEMORIA 32GB, TRANSMISION 4G O WIFI, VISION NOCTURNA, FOTOGRAFIAS DE 16MP, GPS INTERCONSTRUIDO Y BATERIA 4400MAH.	10,000.00		0.00	0.00	10,000.00	
1 2 4 2 3 025 022 001 052	CAMARAS DE SOLAPACAMARA DE SOLAPA MARCA HIKVISION, MEMORIA 32GB, TRANSMISION 4G O WIFI, VISION NOCTURNA, FOTOGRAFIAS DE 16MP, GPS INTERCONSTRUIDO Y BATERIA 4400MAH.	10,000.00		0.00	0.00	10,000.00	
1 2 4 2 3 025 022 001 053	CAMARAS DE SOLAPACAMARA DE SOLAPA MARCA HIKVISION, MEMORIA 32GB, TRANSMISION 4G O WIFI, VISION NOCTURNA, FOTOGRAFIAS DE 16MP, GPS INTERCONSTRUIDO Y BATERIA 4400MAH.	10,000.00		0.00	0.00	10,000.00	
1 2 4 2 3 025 022 001 054	CAMARAS DE SOLAPACAMARA DE SOLAPA MARCA HIKVISION, MEMORIA 32GB, TRANSMISION 4G O WIFI, VISION NOCTURNA, FOTOGRAFIAS DE 16MP, GPS INTERCONSTRUIDO Y BATERIA 4400MAH.	10,000.00		0.00	0.00	10,000.00	
1 2 4 2 3 025 022 001 055	CAMARAS DE SOLAPACAMARA DE SOLAPA MARCA HIKVISION, MEMORIA 32GB, TRANSMISION 4G O WIFI, VISION NOCTURNA, FOTOGRAFIAS DE 16MP, GPS INTERCONSTRUIDO Y BATERIA 4400MAH.	10,000.00		0.00	0.00	10,000.00	
1 2 4 2 3 025 022 001 056	CAMARAS DE SOLAPACAMARA DE SOLAPA MARCA HIKVISION, MEMORIA 32GB, TRANSMISION 4G O WIFI, VISION NOCTURNA, FOTOGRAFIAS DE 16MP, GPS INTERCONSTRUIDO Y BATERIA 4400MAH.	10,000.00		0.00	0.00	10,000.00	
1 2 4 2 3 025 022 001 057	CAMARAS DE SOLAPACAMARA DE SOLAPA MARCA HIKVISION, MEMORIA 32GB, TRANSMISION 4G O WIFI, VISION NOCTURNA, FOTOGRAFIAS DE 16MP, GPS INTERCONSTRUIDO Y BATERIA 4400MAH.	10,000.00		0.00	0.00	10,000.00	
1 2 4 2 3 025 022 001 058	CAMARAS DE SOLAPACAMARA DE SOLAPA MARCA HIKVISION, MEMORIA 32GB, TRANSMISION 4G O WIFI, VISION NOCTURNA, FOTOGRAFIAS DE 16MP, GPS INTERCONSTRUIDO Y BATERIA 4400MAH.	10,000.00		0.00	0.00	10,000.00	
1 2 4 2 3 025 022 001 059	CAMARAS DE SOLAPACAMARA DE SOLAPA MARCA HIKVISION, MEMORIA 32GB, TRANSMISION 4G O WIFI, VISION NOCTURNA, FOTOGRAFIAS DE 16MP, GPS INTERCONSTRUIDO Y BATERIA 4400MAH.	10,000.00		0.00	0.00	10,000.00	
1 2 4 2 3 025 022 001 060	CAMARAS DE SOLAPACAMARA DE SOLAPA MARCA HIKVISION, MEMORIA 32GB, TRANSMISION 4G O WIFI, VISION NOCTURNA, FOTOGRAFIAS DE 16MP, GPS INTERCONSTRUIDO Y BATERIA 4400MAH.	10,000.00		0.00	0.00	10,000.00	
1 2 4 2 3 025 025	EJERCICIO 2019	0.00		200,000.00	0.00	200,000.00	

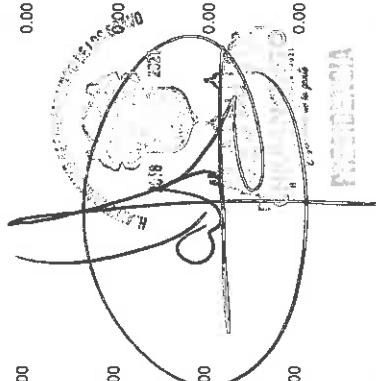

H. Ayuntamiento Municipal de Chilpancingo, Gro. SECRETARIA DE FINANZAS Y ADMINISTRACION



H. AYUNTAMIENTO MUNICIPAL DE CHILPANCINGO, GRO.

SECRETARIA DE FINANZAS Y ADMINISTRACION

CONSOLIDADO



BALANZA DE COMPROBACIÓN DEL 1 DE ENERO AL 31 DE DICIEMBRE DEL 2019

C U E N T A	C O N C E P T O	SALDOS INICIALES		MOVIMIENTOS		SALDOS ACUMULADOS	
		AL 1 DE ENERO DE 2019		ENERO - DICIEMBRE 2019		AL 31 DE DICIEMBRE DE 2019	
		DEBE	HABER	DEBE	HABER	DEBE	HABER
12423025026001	CAMARAS DE SOLAPA	0.00		200,000.00	0.00	200,000.00	
12423025026001001	CAMARAS DE SOLAPA (1)	0.00		10,000.00	0.00	10,000.00	
12423025026001002	CAMARAS DE SOLAPA (2)	0.00		10,000.00	0.00	10,000.00	
12423025026001003	CAMARAS DE SOLAPA (3)	0.00		10,000.00	0.00	10,000.00	
12423025026001004	CAMARAS DE SOLAPA (4)	0.00		10,000.00	0.00	10,000.00	
12423025026001005	CAMARAS DE SOLAPA (5)	0.00		10,000.00	0.00	10,000.00	
12423025026001006	CAMARAS DE SOLAPA (6)	0.00		10,000.00	0.00	10,000.00	
12423025026001007	CAMARAS DE SOLAPA (7)	0.00		10,000.00	0.00	10,000.00	
12423025026001008	CAMARAS DE SOLAPA (8)	0.00		10,000.00	0.00	10,000.00	
12423025026001009	CAMARAS DE SOLAPA (9)	0.00		10,000.00	0.00	10,000.00	
12423025026001010	CAMARAS DE SOLAPA (10)	0.00		10,000.00	0.00	10,000.00	
12423025026001011	CAMARAS DE SOLAPA (11)	0.00		10,000.00	0.00	10,000.00	
12423025026001012	CAMARAS DE SOLAPA (12)	0.00		10,000.00	0.00	10,000.00	
12423025026001013	CAMARAS DE SOLAPA (13)	0.00		10,000.00	0.00	10,000.00	
12423025026001014	CAMARAS DE SOLAPA (14)	0.00		10,000.00	0.00	10,000.00	
12423025026001015	CAMARAS DE SOLAPA (15)	0.00		10,000.00	0.00	10,000.00	
12423025026001016	CAMARAS DE SOLAPA (16)	0.00		10,000.00	0.00	10,000.00	
12423025026001017	CAMARAS DE SOLAPA (17)	0.00		10,000.00	0.00	10,000.00	
12423025026001018	CAMARAS DE SOLAPA (18)	0.00		10,000.00	0.00	10,000.00	
12423025026001019	CAMARAS DE SOLAPA (19)	0.00		10,000.00	0.00	10,000.00	
12423025026001020	CAMARAS DE SOLAPA (20)	0.00		10,000.00	0.00	10,000.00	
12423040	INGRESOS PROPIOS						
12423040026	EJERCICIO 2019			32,849.25	0.00	32,849.25	
12423040026001	OTROS MOBILIARIOS Y EQUIPO EDUCACIONAL Y RECREATIVO			32,849.25	0.00	32,849.25	
12424	OTROS MOBILIARIOS Y EQUIPO EDUCACIONAL Y RECREATIVO						
12424001	GASTO CORRIENTE	441,575.42		0.00	0.00	441,575.42	
12424001004	ADMON 2006 - 2012	162,734.62		0.00	0.00	162,734.62	
12424001004001	OTROS MOBILIARIOS Y EQUIPO EDUCACIONAL Y RECREATIVO	162,734.62		0.00	0.00	162,734.62	
12424021	GASTO CORRIENTE	278,840.80		0.00	0.00	278,840.80	
12424021021	EJERCICIO 2016	278,840.80		0.00	0.00	278,840.80	
12424021021001	OTROS MOBILIARIOS Y EQUIPO EDUCACIONAL Y RECREATIVO	278,840.80		0.00	0.00	278,840.80	
1243	EQUIPO E INSTRUMENTAL MÉDICO Y DE LABORATORIO	2,721,637.94		0.00	0.00	2,721,637.94	

2019

*[Handwritten signature]*

SECRETARIA DE FINANZAS Y ADMINISTRACION

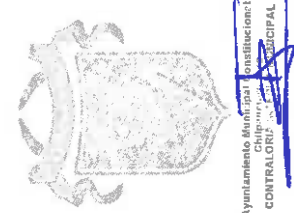



H. AYUNTAMIENTO MUNICIPAL DE CHILPANCINGO, GRO.

SECRETARIA DE FINANZAS Y ADMINISTRACION

CONSOLIDADO



BALANZA DE COMPROBACIÓN DEL 1 DE ENERO AL 31 DE DICIEMBRE DEL 2019

C U E N T A	C O N C E P T O	SALDOS INICIALES		MOVIMIENTOS		SALDOS ACUMULADOS	
		AL 1 DE ENERO DE 2019		ENERO - DICIEMBRE 2019		AL 31 DE DICIEMBRE DE 2019	
		DEBE	HABER	DEBE	HABER	DEBE	HABER
12431	EQUIPO MÉDICO Y DE LABORATORIO	2,721,637.94		0.00		2,721,637.94	
12431001	GASTO CORRIENTE	2,597,555.02		0.00		2,597,555.02	
12431001004	ADMON 2009 - 2012	2,597,555.02		0.00		2,597,555.02	
12431001004001	EQUIPO MEDICO Y DE LABORATORIO	2,597,555.02		0.00		2,597,555.02	
12431003	FONDO DE APORT P/FORT DE LOS MPIO			0.00			
12431003004	ADMON 2009 - 2012	27,524.92		0.00		27,524.92	
12431003004001	EQUIPO MEDICO Y DE LABORATORIO	27,524.92		0.00		27,524.92	
12431021	GASTO CORRIENTE	96,558.00		0.00		96,558.00	
12431021021	ADMON 2009 - 2012	88,558.00		0.00		88,558.00	
12431021021001	EQUIPO MEDICO Y DE LABORATORIO	88,558.00		0.00		88,558.00	
12431021023	EJERCICIO 2017 (ADMON NVA OCT-DIC/17)	8,000.00		0.00		8,000.00	
12431021023001	EQUIPO MEDICO Y DE LABORATORIO	8,000.00		0.00		8,000.00	
12431021023001001	EVACUADOR DE HUMOS MARCA WEM	8,000.00		0.00		8,000.00	
1244	Vehiculos y Equipo de Transporte	8,000.00		0.00		8,000.00	
12441	AUTOMÓVILES Y EQUIPO TERRESTRE	75,398,947.01		0.00		75,398,947.01	
12441001	GASTO CORRIENTE	72,224,715.01		0.00		72,224,715.01	
12441001004	ADMON 2009 - 2012	36,199,282.66		0.00		36,199,282.66	
12441001004001	VEHICULOS Y EQUIPO TERRESTRE PARA LA EJECUCION DE PROGRAMAS DE SEGURIDAD PUBLICA	36,199,282.66		0.00		36,199,282.66	
12441002	FONDO DE APORT P/INFRA SOC MPAL			0.00			
12441002005	ADMON 2012-2015	606,815.98		0.00		606,815.98	
12441002005001	VEHICULOS Y EQUIPO DE TRANSPORTE	606,815.98		0.00		606,815.98	
12441003	FONDO DE APORT P/FORT DE LOS MPIO	17,977,716.41		0.00		17,977,716.41	
12441003005	ADMON 2012 - 2015	17,977,716.41		0.00		17,977,716.41	
12441003005002	VEHICULOS Y EQUIPO TERRESTRE PARA LA EJECUCION DE PROGRAMAS DE SEGURIDAD PUBLICA	17,977,716.41		0.00		17,977,716.41	
12441004	CONVENIOS	3,254,999.97		0.00		3,254,999.97	
12441004005	ADMON 2012-2015	3,254,999.97		0.00		3,254,999.97	
12441004005002	DE CARGA	3,254,999.97		0.00		3,254,999.97	
12441021	GASTO CORRIENTE	4,000,000.00		0.00		4,000,000.00	
12441021022	EJERCICIO 2017	320,000.00		0.00		320,000.00	
12441021022002	DE CARGA	320,000.00		0.00		320,000.00	
12441021022002001	CANION MARCA CHEVROLET TIPO LODIAK CHASSIS CABINA 2008 SERIE	320,000.00		0.00		320,000.00	
Coram/ Balanza		320,000.00		0.00		320,000.00	

*[Handwritten signature and stamp]*



SECRETARIA DE FINANZAS Y ADMINISTRACION  
MUNICIPALIDAD DE CHILPANCINGO, GRO.



H. AYUNTAMIENTO MUNICIPAL DE CHILPANCINGO, GRO.

SECRETARIA DE FINANZAS Y ADMINISTRACION

CONSOLIDADO



BALANZA DE COMPROBACIÓN DEL 1 DE ENERO AL 31 DE DICIEMBRE DEL 2019

C U E N T A	C O N C E P T O	SALDOS INICIALES		MOVIMIENTOS		SALDOS ACUMULADOS	
		AL 1 DE ENERO DE 2019		ENERO - DICIEMBRE 2019		AL 31 DE DICIEMBRE DE 2019	
		DEBE	HABER	DEBE	HABER	DEBE	HABER
12441021024	3GBF7H1C18M12107						
	EJERCICIO 2018						
	DE CARGA						
12441021024002	CAMION RECOLECTOR COMPACTADOR DE BASURA CHASIS CABINA M2106 35K MARCA FREIGHTLINER MOD. 2018	3,680,000.00		0.00		3,680,000.00	
12441021024002002	CAMION RECOLECTOR COMPACTADOR DE BASURA CHASIS CABINA M2106 35K MARCA FREIGHTLINER MOD. 2018	3,680,000.00		0.00		3,680,000.00	
12441023	FONDO DE APORT P/FORT DE LOS NIPIOS	1,840,000.00		0.00		1,840,000.00	
12441023021	EJERCICIO 2016	1,947,900.00		0.00		1,947,900.00	
12441023021001	VEHICULOS Y EQUIPO DESTINADOS A SERVICIOS PUBLICOS Y PROGRAMAS PUBLICOS	1,947,900.00		0.00		1,947,900.00	
12441023021001001	VEHICULOS Y EQUIPO TERRESTRE PARA LA EJECUCION DE PROGRAMAS DE SEGURIDAD PUBLICA	610,900.00		0.00		610,900.00	
12441023021001002	VEHICULOS Y EQUIPOS DESTINADOS A SERVICIOS PUBLICOS Y PROGRAMAS DE SEGURIDAD PUBLICA (SALDOS ENE OCT 2017 CON CUENTA 12441023021001)	1,337,000.00		0.00		1,337,000.00	
12441025	FORTASEG						
12441025021	EJERCICIO 2016	8,236,999.99		4,166,100.00		12,403,099.99	
12441025021001	VEHICULOS Y EQUIPO TERRESTRE PARA LA EJECUCION DE PROGRAMAS DE SEGURIDAD PUBLICA	3,299,999.99		0.00		3,299,999.99	
12441025022	EJERCICIO 2017	3,299,999.99		0.00		3,299,999.99	
12441025022001	VEHICULOS Y EQUIPO TERRESTRE PARA LA EJECUCION DE PROGRAMAS DE SEGURIDAD PUBLICA	2,400,000.00		0.00		2,400,000.00	
12441025022001002	CAMIONETA PICKUP DOBLE CABINA MARCA DODGE RAM MOD. 2017 MOTOR 5.7 L V6 HEM@ MDS VVT, POTENCIA 395 C.F TRANSMISION AUTOMATICA DE 6 VELOCIDADES (AUTOPATRULLA)	600,000.00		0.00		600,000.00	
12441025022001003	CAMIONETA PICKUP DOBLE CABINA MARCA DODGE RAM MOD. 2017 MOTOR 5.7 L V6 HEM@ MDS VVT, POTENCIA 395 C.F TRANSMISION AUTOMATICA DE 6 VELOCIDADES (AUTOPATRULLA)	600,000.00		0.00		600,000.00	
12441025022001004	CAMIONETA PICKUP DOBLE CABINA MARCA DODGE RAM MOD. 2017 MOTOR 5.7 L V6 HEM@ MDS VVT, POTENCIA 395 C.F TRANSMISION AUTOMATICA DE 6 VELOCIDADES (AUTOPATRULLA)	600,000.00		0.00		600,000.00	

Handwritten signature and stamp



M. Ayuntamiento Municipal de Chilpancingo, Gro.



H. AYUNTAMIENTO MUNICIPAL DE CHILPANCINGO, GRO.

SECRETARIA DE FINANZAS Y ADMINISTRACION

CONSOLIDADO



BALANZA DE COMPROBACIÓN DEL 1 DE ENERO AL 31 DE DICIEMBRE DEL 2019

C U E N T A	C O N C E P T O	SALDOS INICIALES		M O V I M I E N T O S		SALDOS ACUMULADOS	
		AL 1 DE ENERO DE 2019		ENERO - DICIEMBRE 2019		AL 31 DE DICIEMBRE DE 2019	
		DEBE	HABER	DEBE	HABER	DEBE	HABER
12 4 4 1 0 2 5 0 2 4	(AUTOPATRULLA)						
	EJERCICIO 2018						
12 4 4 1 0 2 5 0 2 4 0 0 1	VEHICULOS Y EQUIPO TERRESTRE PARA LA EJECUCION DE PROGRAMAS DE SEGURIDAD PUBLICA	2,100,000.00		0.00	0.00	2,100,000.00	
12 4 4 1 0 2 5 0 2 4 0 0 1 0 0 1	CAMIONETA PICKUP RAM DOBLE CABINA MARCA DODGE 4X2 MODELO 2018 No SERIE 3C65RADT8JG246812	2,100,000.00		0.00	0.00	2,100,000.00	
12 4 4 1 0 2 5 0 2 4 0 0 1 0 0 4	CAMIONETA PICKUP RAM DOBLE CABINA MARCA DODGE 4X2 MODELO 2018 No SERIE 3C65RADT8JG246812	700,000.00		0.00	0.00	700,000.00	
12 4 4 1 0 2 5 0 2 4 0 0 1 0 0 5	CAMIONETA MARCA DODGE RAM .PICK UP. DOBLE CABINA MOD.2019 MOTOR 5.7 L V8 HEM@ MDS WT	700,000.00		0.00	0.00	700,000.00	
12 4 4 1 0 2 5 0 2 4 0 0 1 0 0 6	CAMIONETA MARCA DODGE RAM .PICK UP. DOBLE CABINA MOD.2019 MOTOR 5.7 L V8 HEM@ MDS VVT	700,000.00		0.00	0.00	700,000.00	
12 4 4 1 0 2 5 0 2 5	EJERCICIO 2018 (NVA ADMON 2018-2021)	437,000.00		0.00	0.00	437,000.00	
12 4 4 1 0 2 5 0 2 5 0 0 1	VEHICULOS Y EQUIPO TERRESTRE PARA LA EJECUCION DE PROG. DE SEG PUB (COPARTICIPACION)	437,000.00		0.00	0.00	437,000.00	
12 4 4 1 0 2 5 0 2 5 0 0 1 0 0 1	AUTOMOVIL JETTA TREDLINE MARCA VOLKSWAGEN MODELO 2018 No SERIE 3WVW1W1A8JM2590203	437,000.00		0.00	0.00	437,000.00	
12 4 4 1 0 2 5 0 2 6	EJERCICIO 2019						
12 4 4 1 0 2 5 0 2 6 0 0 1	VEHICULOS Y EQUIPO TERRESTRE PARA LA EJECUCION DEL PROG DE SEG PUBLICA VEHICULO NUEVO No DE SERIE 3N1A87AS6KY372303 No DE MOTOR MRA8675740J	0.00		4,166,100.00	0.00	4,166,100.00	
12 4 4 1 0 2 5 0 2 6 0 0 1 0 0 1	MARCA NISSAN TIPO SENTRA SENSE MODELO 2019 EQUIPADO DE: 01 BARRA DE LUCES COLOR ROJO/AZUL MODELO LEGEND LGD45-2633906.01 SIRENA ELECTRONICA MODELO PA650 (AS422/65FS) Y MICROFONO CON CONTROL DE LUCES UNIMANDO INTEGRADO DE USO RUDO PARA VOCEO Y UNA BOCINA DE 100 WATTS MODELO TS100N DE LA MARCA FEDERAL SIGNAL, 01 CENTRO DE BURRERA, 01 PORTA ESPOSAS, 01 GANCHO DE ARRASTRE Y 01 MAMPARA DE LA MARCA DE THUNDER E INCLUYE 01 ROTULACION Y APLICACION DE PINTURA A PUERTA CERRADA DE ACUERDO CON EL SISTEMA NACIONAL DE SEGURIDAD PUBLICA (FORTASEG)	0.00		4,166,100.00	0.00	4,166,100.00	
12 4 4 1 0 2 5 0 2 6 0 0 1 0 0 2	VEHICULO NUEVO No DE SERIE 3N1A87AS6KY373824 No DE MOTOR MRA8674342J	0.00		479,025.00	0.00	479,025.00	
	MARCA NISSAN TIPO SENTRA SENSE MODELO 2019 EQUIPADO DE: 01 BARRA DE LUCES COLOR ROJO/AZUL MODELO LEGEND LGD45-2633906.01 SIRENA ELECTRONICA MODELO PA650 (AS422/65FS) Y MICROFONO CON CONTROL DE LUCES UNIMANDO INTEGRADO DE USO RUDO PARA VOCEO Y UNA BOCINA DE 100 WATTS MODELO TS100N DE LA MARCA FEDERAL SIGNAL, 01 CENTRO DE BURRERA, 01 PORTA ESPOSAS, 01						

*[Handwritten signature and stamp]*

*[Official stamp and signature]*

AYUNTAMIENTO MUNICIPAL DE CHILPANCINGO DE LOS FUEROS, GRO. 2019

SECRETARIA DE FINANZAS





H. AYUNTAMIENTO MUNICIPAL DE CHILPANCINGO, GRO.

SECRETARIA DE FINANZAS Y ADMINISTRACION

CONSOLIDADO



BALANZA DE COMPROBACION DEL 1 DE ENERO AL 31 DE DICIEMBRE DEL 2019

C U E N T A	C O N C E P T O	SALDOS INICIALES		M O V I M I E N T O S		SALDOS ACUMULADOS		
		AL 1 DE ENERO DE 2019		ENERO - DICIEMBRE 2019		AL 31 DE DICIEMBRE DE 2019		
		DEBE	HABER	DEBE	HABER	DEBE	HABER	
1 2 4 4 1 0 2 5 0 2 6 0 0 1 0 0 3	GANCHO DE ARRASTRE Y 01 MAMPARA DE LA MARCA DE THUNER E INCLUYE 01 ROTULACION Y APLICACION DE PINTURA A PUERTA CERRADA DE ACUERDO CON EL SISTEMA NACIONAL DE SEGURIDAD PUBLICA (FORTASEG) VEHICULO NUEVO NO DE SERIE 3NIAB7ADIKY378788 NO DE MOTOR MRA8680277J MARCA NISSAN TIPO SENTRA SENSE MODELO 2019 EQUIPADO DE: 01 BARRA DE LUCES COLOR ROJO/AZUL MODELO LEGEND LGD45-2633906.01 SIRENA ELECTRONICA MODELO PA650 (AS422/65FS) Y MICROFONO CON CONTROL DE LUCES UNIMANDO INTEGRADO DE USO RUDO PARA VOCEO Y UNA BOCINA DE 100 WATTS MODELO TS100N DE LA MARCA FEDERAL SIGNAL, 01 CENTRO DE BURRERA, 01 PORTA ESPOSAS, 01 GANCHO DE ARRASTRE Y 01 MAMPARA DE LA MARCA DE THUNER E INCLUYE 01 ROTULACION Y APLICACION DE PINTURA A PUERTA CERRADA DE ACUERDO CON EL SISTEMA NACIONAL DE SEGURIDAD PUBLICA (FORTASEG) VEHICULO NUEVO NO DE SERIE 3NIAB7AD6KY372320 NO DE MOTOR MRA8674312J MARCA NISSAN TIPO SENTRA SENSE MODELO 2019 EQUIPADO DE: 01 BARRA DE LUCES COLOR ROJO/AZUL MODELO LEGEND LGD45-2633906.01 SIRENA ELECTRONICA MODELO PA650 (AS422/65FS) Y MICROFONO CON CONTROL DE LUCES UNIMANDO INTEGRADO DE USO RUDO PARA VOCEO Y UNA BOCINA DE 100 WATTS MODELO TS100N DE LA MARCA FEDERAL SIGNAL, 01 CENTRO DE BURRERA, 01 PORTA ESPOSAS, 01 GANCHO DE ARRASTRE Y 01 MAMPARA DE LA MARCA DE THUNER E INCLUYE 01 ROTULACION Y APLICACION DE PINTURA A PUERTA CERRADA DE ACUERDO CON EL SISTEMA NACIONAL DE SEGURIDAD PUBLICA (FORTASEG) CAMIONETA TIPO PICK UP RIMA CREW CAB. 2500 4X2 DOBLE CABINA V8 MODELO 2019 NO DE SERIE: 3C6SRADT3KG87843 NO DE MOTOR HECHO EN MEXICO 01 BARRA DE LUCECES COLOR ROJO/AZUL MODELO LEGEND LGD45Z-PA650 (AS422/65FS) Y MICROFONO CON CONTROL DE LUCES UNIMANDO INTEGRADO DE USO RUDO PARA VOCEO Y UNA BOCINA DE 100 WATTS MODELO TS100 01 KIT DE 4 ESTROBOS CONERLED EN TONO CLARO CON FUENTE DE PODER Y CABLES, MODELO 41620065 DE LA MARCA FEDERAL SIGNAL 01 CENTRO DE BURRERA EUROGUARD PERSONALIZADA 01 ROLL BAR TIPO P.F.P. 01 BANCA CENTRAL CON	0.00	0.00	479,025.00	0.00	479,025.00	0.00	479,025.00
1 2 4 4 1 0 2 5 0 2 6 0 0 1 0 0 4	GANCHO DE ARRASTRE Y 01 MAMPARA DE LA MARCA DE THUNER E INCLUYE 01 ROTULACION Y APLICACION DE PINTURA A PUERTA CERRADA DE ACUERDO CON EL SISTEMA NACIONAL DE SEGURIDAD PUBLICA (FORTASEG) VEHICULO NUEVO NO DE SERIE 3NIAB7AD6KY372320 NO DE MOTOR MRA8674312J MARCA NISSAN TIPO SENTRA SENSE MODELO 2019 EQUIPADO DE: 01 BARRA DE LUCES COLOR ROJO/AZUL MODELO LEGEND LGD45-2633906.01 SIRENA ELECTRONICA MODELO PA650 (AS422/65FS) Y MICROFONO CON CONTROL DE LUCES UNIMANDO INTEGRADO DE USO RUDO PARA VOCEO Y UNA BOCINA DE 100 WATTS MODELO TS100N DE LA MARCA FEDERAL SIGNAL, 01 CENTRO DE BURRERA, 01 PORTA ESPOSAS, 01 GANCHO DE ARRASTRE Y 01 MAMPARA DE LA MARCA DE THUNER E INCLUYE 01 ROTULACION Y APLICACION DE PINTURA A PUERTA CERRADA DE ACUERDO CON EL SISTEMA NACIONAL DE SEGURIDAD PUBLICA (FORTASEG) CAMIONETA TIPO PICK UP RIMA CREW CAB. 2500 4X2 DOBLE CABINA V8 MODELO 2019 NO DE SERIE: 3C6SRADT3KG87843 NO DE MOTOR HECHO EN MEXICO 01 BARRA DE LUCECES COLOR ROJO/AZUL MODELO LEGEND LGD45Z-PA650 (AS422/65FS) Y MICROFONO CON CONTROL DE LUCES UNIMANDO INTEGRADO DE USO RUDO PARA VOCEO Y UNA BOCINA DE 100 WATTS MODELO TS100 01 KIT DE 4 ESTROBOS CONERLED EN TONO CLARO CON FUENTE DE PODER Y CABLES, MODELO 41620065 DE LA MARCA FEDERAL SIGNAL 01 CENTRO DE BURRERA EUROGUARD PERSONALIZADA 01 ROLL BAR TIPO P.F.P. 01 BANCA CENTRAL CON	0.00	0.00	479,025.00	0.00	479,025.00	0.00	479,025.00
1 2 4 4 1 0 2 5 0 2 6 0 0 1 0 0 5	GANCHO DE ARRASTRE Y 01 MAMPARA DE LA MARCA DE THUNER E INCLUYE 01 ROTULACION Y APLICACION DE PINTURA A PUERTA CERRADA DE ACUERDO CON EL SISTEMA NACIONAL DE SEGURIDAD PUBLICA (FORTASEG) VEHICULO NUEVO NO DE SERIE 3NIAB7AD6KY372320 NO DE MOTOR MRA8674312J MARCA NISSAN TIPO SENTRA SENSE MODELO 2019 EQUIPADO DE: 01 BARRA DE LUCES COLOR ROJO/AZUL MODELO LEGEND LGD45-2633906.01 SIRENA ELECTRONICA MODELO PA650 (AS422/65FS) Y MICROFONO CON CONTROL DE LUCES UNIMANDO INTEGRADO DE USO RUDO PARA VOCEO Y UNA BOCINA DE 100 WATTS MODELO TS100N DE LA MARCA FEDERAL SIGNAL, 01 CENTRO DE BURRERA, 01 PORTA ESPOSAS, 01 GANCHO DE ARRASTRE Y 01 MAMPARA DE LA MARCA DE THUNER E INCLUYE 01 ROTULACION Y APLICACION DE PINTURA A PUERTA CERRADA DE ACUERDO CON EL SISTEMA NACIONAL DE SEGURIDAD PUBLICA (FORTASEG) CAMIONETA TIPO PICK UP RIMA CREW CAB. 2500 4X2 DOBLE CABINA V8 MODELO 2019 NO DE SERIE: 3C6SRADT3KG87843 NO DE MOTOR HECHO EN MEXICO 01 BARRA DE LUCECES COLOR ROJO/AZUL MODELO LEGEND LGD45Z-PA650 (AS422/65FS) Y MICROFONO CON CONTROL DE LUCES UNIMANDO INTEGRADO DE USO RUDO PARA VOCEO Y UNA BOCINA DE 100 WATTS MODELO TS100 01 KIT DE 4 ESTROBOS CONERLED EN TONO CLARO CON FUENTE DE PODER Y CABLES, MODELO 41620065 DE LA MARCA FEDERAL SIGNAL 01 CENTRO DE BURRERA EUROGUARD PERSONALIZADA 01 ROLL BAR TIPO P.F.P. 01 BANCA CENTRAL CON	0.00	0.00	750,000.00	0.00	750,000.00	0.00	750,000.00

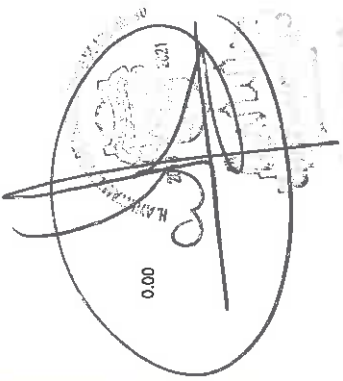

M. Ayuntamiento Chilpancingo  
SECRETARIA DE FINANZAS Y ADMINISTRACION  
CONTRALORIA MUNICIPAL

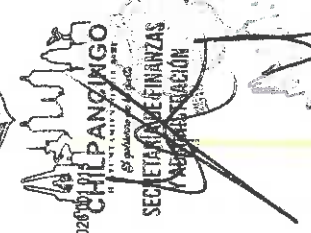

Coram/ Balanza

6.08.08 PM

miercoles 25 marzo 2020



H. AYUNTAMIENTO MUNICIPAL DE CHILPANCINGO, GRO.

SECRETARIA DE FINANZAS Y ADMINISTRACION

CONSOLIDADO



BALANZA DE COMPROBACION DEL 1 DE ENERO AL 31 DE DICIEMBRE DEL 2019

C U E N T A	C O N C E P T O	SALDOS INICIALES		M O V I M I E N T O S		SALDOS ACUMULADOS		
		AL 1 DE ENERO DE 2019		ENERO - DICIEMBRE 2019		AL 31 DE DICIEMBRE DE 2019		
		DEBE	HABER	DEBE	HABER	DEBE	HABER	
12441025026001016	RESPALDO PUNZONADA 01 DEFENSA TRASERA ANTIDERRAPANTE Y UNA LONA DE LA MARCA THUNDER E INCLUYE 01 ROTULACION Y APLICACION DE PINTURA A PUERTA CERRADA DE ACUERDO CON EL SISTEMA NACIONAL DE SEGURIDAD PUBLICA (FORTASEG) CAMIONETA TIPO PICK UP RIMA CREW CAB 2500 4X2 DOBLE CABINA V8 MODELO 2019 NO DE SERIE: 3C8SRADTKK6587847 NO DE MOTOR HECHO EN MEXICO 01 BARRA DE LUCES COLOR ROJO/AZUL MODELO LEGEND LGD45Z-2633906, 01 SIRENA ELECTRONICA MODELO PA650 (AS422/65FS) Y MICROFONO CON CONTROL DE LUCES UNIMANDO INTEGRADO DE USO RUDO PARA VOCEO Y UNA BOCINA DE 100 WATTS MODELO TS100 01 KIT DE 4 ESTROBOS CONERLED EN TONO CLARO CON FUENTE DE PODER Y CABLES, MODELO 41620055 DE LA MARCA FEDERAL SIGNAL 01 CENTRO DE BARRERA EUROGUARD PERSONALIZADA 01 ROLL BAR TIPO P.F.P 01 BANCA CENTRAL CON RESPALDO PUNZONADA 01 DEFENSA TRASERA ANTIDERRAPANTE Y UNA LONA DE LA MARCA THUNDER E INCLUYE 01 ROTULACION Y APLICACION DE PINTURA A PUERTA CERRADA DE ACUERDO CON EL SISTEMA NACIONAL DE SEGURIDAD PUBLICA (FORTASEG) CAMIONETA TIPO PICK UP RIMA CREW CAB 2500 4X2 DOBLE CABINA V8 MODELO 2019 NO DE SERIE: 3C8SRADTKK65872447 NO DE MOTOR HECHO EN MEXICO 01 BARRA DE LUCES COLOR ROJO/AZUL MODELO LEGEND LGD45Z-2633906, 01 SIRENA ELECTRONICA MODELO PA650 (AS422/65FS) Y MICROFONO CON CONTROL DE LUCES UNIMANDO INTEGRADO DE USO RUDO PARA VOCEO Y UNA BOCINA DE 100 WATTS MODELO TS100 01 KIT DE 4 ESTROBOS CONERLED EN TONO CLARO CON FUENTE DE PODER Y CABLES, MODELO 41620055 DE LA MARCA FEDERAL SIGNAL 01 CENTRO DE BARRERA EUROGUARD PERSONALIZADA 01 ROLL BAR TIPO P.F.P 01 BANCA CENTRAL CON RESPALDO PUNZONADA 01 DEFENSA TRASERA ANTIDERRAPANTE Y UNA LONA DE LA MARCA THUNDER E INCLUYE 01 ROTULACION Y APLICACION DE PINTURA A PUERTA CERRADA DE ACUERDO CON EL SISTEMA NACIONAL DE SEGURIDAD PUBLICA (FORTASEG)	0.00		750,000.00	0.00	750,000.00		750,000.00
12441025026001017	OTROS EQUIPOS DE TRANSPORTE FORTASEG	0.00		2,000,000.00	0.00	2,000,000.00	0.00	2,000,000.00
12449025	Coram/ Balanza			650,000.00	0.00	650,000.00	0.00	650,000.00
12449025	EJERCICIO 2016			3,175,232.00	0.00	3,175,232.00	0.00	3,175,232.00
12449				3,175,232.00	0.00	3,175,232.00	0.00	3,175,232.00

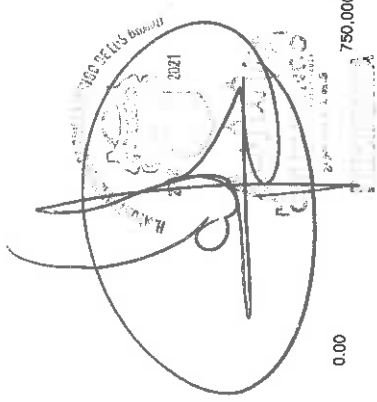
  
 H. Ayuntamiento Municipal Constitucional de Chilpancingo  
 CONTRALORIA INTERNA MUNICIPAL  
 2019

  
 H. Ayuntamiento Municipal Constitucional de Chilpancingo  
 CONTRALORIA INTERNA MUNICIPAL





H. AYUNTAMIENTO MUNICIPAL DE CHILPANCINGO, GRO.

SECRETARIA DE FINANZAS Y ADMINISTRACION

CONSOLIDADO



BALANZA DE COMPROBACION DEL 1 DE ENERO AL 31 DE DICIEMBRE DEL 2019

C U E N T A	C O N C E P T O	SALDOS INICIALES		M O V I M I E N T O S		SALDOS ACUMULADOS	
		AL 1 DE ENERO DE 2019		ENERO - DICIEMBRE 2019		AL 31 DE DICIEMBRE DE 2019	
		DEBE	HABER	DEBE	HABER	DEBE	HABER
12449 025 026	EJERCICIO 2019	0.00		2,000,000.00	0.00	2,000,000.00	
12449 025 026 001	EQUIPO TERRESTRE (MOTOCICLETAS)	0.00		2,000,000.00	0.00	2,000,000.00	
12449 025 026 001 001	MOTOCICLETA MARCA HONDA MODELO XER300	0.00		200,000.00	0.00	200,000.00	
	2019 EQUIPADA PARA PATRULLA No DE SERIE						
	9C2ND1218JR610239 No DE MOTOR						
	ND12E1J610284						
12449 025 026 001 002	MOTOCICLETA MARCA HONDA MODELO XER300	0.00		200,000.00	0.00	200,000.00	
	2019 EQUIPADA PARA PATRULLA No DE SERIE						
	9C2ND1217JR610250, No DE MOTOR						
	ND12E1J610219						
12449 025 026 001 003	MOTOCICLETA MARCA HONDA MODELO XER300	0.00		200,000.00	0.00	200,000.00	
	2019 EQUIPADA PARA PATRULLA No DE SERIE						
	9C2ND1219JR610248, No DE MOTOR						
	ND12E1J610273						
12449 025 026 001 004	MOTOCICLETA MARCA HONDA MODELO XER300	0.00		200,000.00	0.00	200,000.00	
	2019 EQUIPADA PARA PATRULLA No DE SERIE						
	9C2ND1214JR610268, No DE MOTOR						
	ND12E1J610249						
12449 025 026 001 005	MOTOCICLETA MARCA HONDA MODELO XER300	0.00		200,000.00	0.00	200,000.00	
	2019 EQUIPADA PARA PATRULLA No DE SERIE						
	9CND1216JR610272, No DE MOTOR						
	ND12E1J610149						
12449 025 026 001 006	MOTOCICLETA MARCA HONDA MODELO XER300	0.00		200,000.00	0.00	200,000.00	
	2019 EQUIPADA PARA PATRULLA No DE SERIE						
	9C2ND1213JR610257, No DE MOTOR						
	ND12E1J610239						
12449 025 026 001 007	MOTOCICLETA MARCA HONDA MODELO XER300	0.00		200,000.00	0.00	200,000.00	
	2019 EQUIPADA PARA PATRULLA No DE SERIE						
	9C2ND1210JR610221, No DE MOTOR						
	ND12E1J610244						
12449 025 026 001 008	MOTOCICLETA MARCA HONDA MODELO XER300	0.00		200,000.00	0.00	200,000.00	
	EQUIPADA PARA PATRULLA No DE SERIE						
	9C2ND1213JR610228 No DE MOTOR						
	ND12E1J610239						
12449 025 026 001 009	MOTOCICLETA MARCA HONDA MODELO XER300	0.00		200,000.00	0.00	200,000.00	
	EQUIPADA PARA PATRULLA No DE SERIE						
	9C2ND1210JR610249, No DE MOTOR						
	ND12E1J610276						
12449 025 026 001 010	MOTOCICLETA MARCA HONDA MODELO XER300	0.00		200,000.00	0.00	200,000.00	
	EQUIPADA PARA PATRULLA No DE SERIE						
	9C2ND1214JR610254, No DE MOTOR						
	ND12E1J610278						
1245	EQUIPO DE DEFENSA Y SEGURIDAD	5,351,247.74		1,250,000.00	0.00	6,601,247.74	
12451	CONVENIOS	682,882.00		1,250,000.00	0.00	1,932,882.00	
12451 004	EQUIPO DE DEFENSA Y SEGURIDAD	682,882.00		0.00	0.00	682,882.00	
12451 004 005	EQUIPO DE DEFENSA GRUPO TACTICO	4,668,365.74		1,250,000.00	0.00	5,918,365.74	
12451 025	FORTASEG	1,885,999.80		0.00	0.00	1,885,999.80	
12451 025 021	EJERCICIO 2016						

SECRETARIA DE FINANZAS Y ADMINISTRACION  
 2019

SECRETARIA DE FINANZAS Y ADMINISTRACION  
 2019

AYUNTAMIENTO MUNICIPAL DE CHILPANCINGO DE LOS SANTOS  
 2019  
 SECRETARIA DE FINANZAS Y ADMINISTRACION  
 CHILPANCINGO  
 6:38:08 PM



H. AYUNTAMIENTO MUNICIPAL DE CHILPANCINGO, GRO.

SECRETARIA DE FINANZAS Y ADMINISTRACION

CONSOLIDADO



BALANZA DE COMPROBACION DEL 1 DE ENERO AL 31 DE DICIEMBRE DEL 2019

C U E N T A	C O N C E P T O	SALDOS INICIALES		M O V I M I E N T O S		SALDOS ACUMULADOS	
		AL 1 DE ENERO DE 2019		ENERO - DICIEMBRE 2019		AL 31 DE DICIEMBRE DE 2019	
		DEBE	HABER	DEBE	HABER	DEBE	HABER
12451025021002	EQUIPO DE SEGURIDAD PUBLICA	936,000.00		0.00		936,000.00	
12451025021003	KIT DE OPERACION DEL 1ER RESPONDIENTE ( PATRUILLA)	150,000.00		0.00		150,000.00	
12451025021004	KIT DE OPERACION DEL 1ER RESPONDIENTE ( PIE A TIERRA )	799,999.80		0.00		799,999.80	
12451025022	EJERCICIO 2017	1,463,516.00		0.00		1,463,516.00	
12451025022001	EQUIPO DE SEGURIDAD PUBLICA (CHALECOS BALISTICOS)	1,225,000.00		0.00		1,225,000.00	
12451025022001001	CHALECO BALISTICO NIVEL IIIA CON DOS PLACAS BALISTICAS MODELO PC4-01	35,000.00		0.00		35,000.00	
12451025022001002	CHALECO BALISTICO NIVEL IIIA CON DOS PLACAS BALISTICAS MODELO PC4-01	35,000.00		0.00		35,000.00	
12451025022001003	CHALECO BALISTICO NIVEL IIIA CON DOS PLACAS BALISTICAS MODELO PC4-01	35,000.00		0.00		35,000.00	
12451025022001004	CHALECO BALISTICO NIVEL IIIA CON DOS PLACAS BALISTICAS MODELO PC4-01	35,000.00		0.00		35,000.00	
12451025022001005	CHALECO BALISTICO NIVEL IIIA CON DOS PLACAS BALISTICAS MODELO PC4-01	35,000.00		0.00		35,000.00	
12451025022001006	CHALECO BALISTICO NIVEL IIIA CON DOS PLACAS BALISTICAS MODELO PC4-01	35,000.00		0.00		35,000.00	
12451025022001007	CHALECO BALISTICO NIVEL IIIA CON DOS PLACAS BALISTICAS MODELO PC4-01	35,000.00		0.00		35,000.00	
12451025022001008	CHALECO BALISTICO NIVEL IIIA CON DOS PLACAS BALISTICAS MODELO PC4-01	35,000.00		0.00		35,000.00	
12451025022001009	CHALECO BALISTICO NIVEL IIIA CON DOS PLACAS BALISTICAS MODELO PC4-01	35,000.00		0.00		35,000.00	
12451025022001010	CHALECO BALISTICO NIVEL IIIA CON DOS PLACAS BALISTICAS MODELO PC4-01	35,000.00		0.00		35,000.00	
12451025022001011	CHALECO BALISTICO NIVEL IIIA CON DOS PLACAS BALISTICAS MODELO PC4-01	35,000.00		0.00		35,000.00	
12451025022001012	CHALECO BALISTICO NIVEL IIIA CON DOS PLACAS BALISTICAS MODELO PC4-01	35,000.00		0.00		35,000.00	
12451025022001013	CHALECO BALISTICO NIVEL IIIA CON DOS PLACAS BALISTICAS MODELO PC4-01	35,000.00		0.00		35,000.00	
12451025022001014	CHALECO BALISTICO NIVEL IIIA CON DOS PLACAS BALISTICAS MODELO PC4-01	35,000.00		0.00		35,000.00	
12451025022001015	CHALECO BALISTICO NIVEL IIIA CON DOS PLACAS BALISTICAS MODELO PC4-01	35,000.00		0.00		35,000.00	
12451025022001016	CHALECO BALISTICO NIVEL IIIA CON DOS PLACAS BALISTICAS MODELO PC4-01	35,000.00		0.00		35,000.00	
12451025022001017	CHALECO BALISTICO NIVEL IIIA CON DOS PLACAS BALISTICAS MODELO PC4-01	35,000.00		0.00		35,000.00	
12451025022001018	CHALECO BALISTICO NIVEL IIIA CON DOS PLACAS BALISTICAS MODELO PC4-01	35,000.00		0.00		35,000.00	
12451025022001019	CHALECO BALISTICO NIVEL IIIA CON DOS PLACAS BALISTICAS MODELO PC4-01	35,000.00		0.00		35,000.00	
12451025022001020	CHALECO BALISTICO NIVEL IIIA CON DOS PLACAS BALISTICAS MODELO PC4-01	35,000.00		0.00		35,000.00	
12451025022001021	CHALECO BALISTICO NIVEL IIIA CON DOS PLACAS BALISTICAS MODELO PC4-01	35,000.00		0.00		35,000.00	
12451025022001022	CHALECO BALISTICO NIVEL IIIA CON DOS PLACAS BALISTICAS MODELO PC4-01	35,000.00		0.00		35,000.00	
12451025022001023	CHALECO BALISTICO NIVEL IIIA CON DOS PLACAS BALISTICAS MODELO PC4-01	35,000.00		0.00		35,000.00	

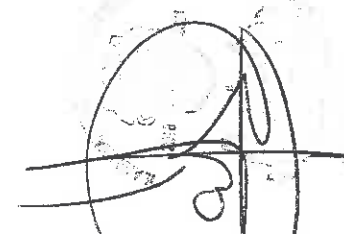

H. Ayuntamiento Municipal  
Comisario Municipal de  
Finanzas y Administracion  
CENTRALORIA INTERMUNICIPAL





H. AYUNTAMIENTO MUNICIPAL DE CHILPANCINGO, GRO.

SECRETARIA DE FINANZAS Y ADMINISTRACION

CONSOLIDADO



BALANZA DE COMPROBACION DEL 1 DE ENERO AL 31 DE DICIEMBRE DEL 2019

CUENTA	CONCEPTO	SALDOS INICIALES		MOVIMIENTOS		SALDOS ACUMULADOS	
		AL 1 DE ENERO DE 2019		ENERO - DICIEMBRE 2019		AL 31 DE DICIEMBRE DE 2019	
		DEBE	HABER	DEBE	HABER	DEBE	HABER
12451025022001024	CHALECO BALISTICO NIVEL IIIA CON DOS PLACAS	35,000.00			0.00	35,000.00	
12451025022001025	BALISTICAS MODELO PC4-01	35,000.00			0.00	35,000.00	
12451025022001026	CHALECO BALISTICO NIVEL IIIA CON DOS PLACAS	35,000.00			0.00	35,000.00	
12451025022001027	BALISTICAS MODELO PC4-01	35,000.00			0.00	35,000.00	
12451025022001028	CHALECO BALISTICO NIVEL IIIA CON DOS PLACAS	35,000.00			0.00	35,000.00	
12451025022001029	BALISTICAS MODELO PC4-01	35,000.00			0.00	35,000.00	
12451025022001030	CHALECO BALISTICO NIVEL IIIA CON DOS PLACAS	35,000.00			0.00	35,000.00	
12451025022001031	BALISTICAS MODELO PC4-01	35,000.00			0.00	35,000.00	
12451025022001032	CHALECO BALISTICO NIVEL IIIA CON DOS PLACAS	35,000.00			0.00	35,000.00	
12451025022001033	BALISTICAS MODELO PC4-01	35,000.00			0.00	35,000.00	
12451025022001034	CHALECO BALISTICO NIVEL IIIA CON DOS PLACAS	35,000.00			0.00	35,000.00	
12451025022001035	BALISTICAS MODELO PC4-01	35,000.00			0.00	35,000.00	
12451025022002	CHALECO BALISTICO NIVEL IIIA CON DOS PLACAS	238,516.00			0.00	238,516.00	
12451025022002001	TACTICOS)	7,950.00			0.00	7,950.00	
12451025022002002	CASCO BALISTICO NIVEL IIIA ULTIMA	7,950.00			0.00	7,950.00	
12451025022002003	GENERACION.	7,950.00			0.00	7,950.00	
12451025022002004	CASCO BALISTICO NIVEL IIIA ULTIMA	7,950.00			0.00	7,950.00	
12451025022002005	GENERACION.	7,950.00			0.00	7,950.00	
12451025022002006	CASCO BALISTICO NIVEL IIIA ULTIMA	7,950.00			0.00	7,950.00	
12451025022002007	GENERACION.	7,950.00			0.00	7,950.00	
12451025022002008	CASCO BALISTICO NIVEL IIIA ULTIMA	7,950.00			0.00	7,950.00	
12451025022002009	GENERACION.	7,950.00			0.00	7,950.00	
12451025022002010	CASCO BALISTICO NIVEL IIIA ULTIMA	7,950.00			0.00	7,950.00	
12451025022002011	GENERACION.	7,950.00			0.00	7,950.00	
12451025022002012	CASCO BALISTICO NIVEL IIIA ULTIMA	7,950.00			0.00	7,950.00	
12451025022002013	GENERACION.	7,950.00			0.00	7,950.00	
12451025022002014	CASCO BALISTICO NIVEL IIIA ULTIMA	7,950.00			0.00	7,950.00	
12451025022002015	GENERACION.	7,950.00			0.00	7,950.00	
Coram/ Balanza		7,950.00			0.00	7,950.00	

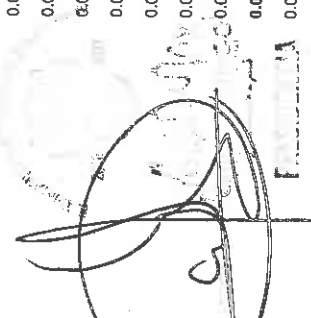

Municipio Municipal Constitucional de Chilpancingo, Gro.  
 SECRETARIA DE FINANZAS Y ADMINISTRACION



H. AYUNTAMIENTO MUNICIPAL DE CHILPANCINGO, GRO.

SECRETARIA DE FINANZAS Y ADMINISTRACION

CONSOLIDADO



BALANZA DE COMPROBACION DEL 1 DE ENERO AL 31 DE DICIEMBRE DEL 2019

C U E N T A	C O N C E P T O	SALDOS INICIALES		MOVIMIENTOS		SALDOS ACUMULADOS	
		AL 1 DE ENERO DE 2019		ENERO - DICIEMBRE 2019		AL 31 DE DICIEMBRE DE 2019	
		DEBE	HABER	DEBE	HABER	DEBE	HABER
	GENERACION.						
12 4 5 1 025 022 002 016	CASCO BALISTICO NIVEL IIIA ULTIMA	7,950.00		0.00		7,950.00	
12 4 5 1 025 022 002 017	GENERACION.						
	CASCO BALISTICO NIVEL IIIA ULTIMA	7,950.00		0.00		7,950.00	
12 4 5 1 025 022 002 018	GENERACION.						
	CASCO BALISTICO NIVEL IIIA ULTIMA	7,950.00		0.00		7,950.00	
12 4 5 1 025 022 002 019	GENERACION.						
	CASCO BALISTICO NIVEL IIIA ULTIMA	7,950.00		0.00		7,950.00	
12 4 5 1 025 022 002 020	GENERACION.						
	CASCO BALISTICO NIVEL IIIA ULTIMA	7,950.00		0.00		7,950.00	
12 4 5 1 025 022 002 021	GENERACION.						
	CASCO BALISTICO NIVEL IIIA ULTIMA	7,950.00		0.00		7,950.00	
12 4 5 1 025 022 002 022	GENERACION.						
	CASCO BALISTICO NIVEL IIIA ULTIMA	7,950.00		0.00		7,950.00	
12 4 5 1 025 022 002 023	GENERACION.						
	CASCO BALISTICO NIVEL IIIA ULTIMA	7,950.00		0.00		7,950.00	
12 4 5 1 025 022 002 024	GENERACION.						
	CASCO BALISTICO NIVEL IIIA ULTIMA	7,950.00		0.00		7,950.00	
12 4 5 1 025 022 002 025	GENERACION.						
	CASCO BALISTICO NIVEL IIIA ULTIMA	7,950.00		0.00		7,950.00	
12 4 5 1 025 022 002 026	GENERACION.						
	CASCO BALISTICO NIVEL IIIA ULTIMA	7,950.00		0.00		7,950.00	
12 4 5 1 025 022 002 027	GENERACION.						
	CASCO BALISTICO NIVEL IIIA ULTIMA	7,950.00		0.00		7,950.00	
12 4 5 1 025 022 002 028	GENERACION.						
	CASCO BALISTICO NIVEL IIIA ULTIMA	7,950.00		0.00		7,950.00	
12 4 5 1 025 022 002 029	GENERACION.						
	CASCO BALISTICO NIVEL IIIA ULTIMA	7,950.00		0.00		7,950.00	
12 4 5 1 025 022 002 030	GENERACION.						
	CASCO BALISTICO NIVEL IIIA ULTIMA	7,950.00		0.00		7,950.00	
12 4 5 1 025 024	EJERCICIO 2018	7,966.00		0.00		7,966.00	
12 4 5 1 025 024 001	EQUIPO DE SEGURIDAD PUBLICA (CHALECOS BALISTICOS)	1,318,849.94		0.00		1,318,849.94	
12 4 5 1 025 024 001 001	CHALECO BALISTICO NIVEL IIIA CON DOS PLACAS	1,249,449.92		0.00		1,249,449.92	
12 4 5 1 025 024 001 002	BALISTICAS NIVEL IV	24,989.00		0.00		24,989.00	
12 4 5 1 025 024 001 003	CHALECO BALISTICO NIVEL IIIA CON DOS PLACAS	24,989.00		0.00		24,989.00	
12 4 5 1 025 024 001 004	BALISTICAS NIVEL IV	24,989.00		0.00		24,989.00	
12 4 5 1 025 024 001 005	CHALECO BALISTICO NIVEL IIIA CON DOS PLACAS	24,989.00		0.00		24,989.00	
12 4 5 1 025 024 001 006	BALISTICAS NIVEL IV	24,989.00		0.00		24,989.00	
12 4 5 1 025 024 001 007	CHALECO BALISTICO NIVEL IIIA CON DOS PLACAS	24,989.00		0.00		24,989.00	
12 4 5 1 025 024 001 008	BALISTICAS NIVEL IV	24,989.00		0.00		24,989.00	
12 4 5 1 025 024 001 009	CHALECO BALISTICO NIVEL IIIA CON DOS PLACAS	24,989.00		0.00		24,989.00	
12 4 5 1 025 024 001 010	BALISTICAS NIVEL IV	24,989.00		0.00		24,989.00	

*[Handwritten signature and stamp]*

*[Handwritten signature and stamp]*



H. AYUNTAMIENTO MUNICIPAL DE CHILPANCINGO, GRO.

SECRETARIA DE FINANZAS Y ADMINISTRACION

CONSOLIDADO



BALANZA DE COMPROBACIÓN DEL 1 DE ENERO AL 31 DE DICIEMBRE DEL 2019

C U E N T A	C O N C E P T O	SALDOS INICIALES		MOVIMIENTOS		SALDOS ACUMULADOS	
		AL 1 DE ENERO DE 2019		ENERO - DICIEMBRE 2019		AL 31 DE DICIEMBRE DE 2019	
		DEBE	HABER	DEBE	HABER	DEBE	HABER
12451025024001011	CHALECO BALISTICO NIVEL IIIA CON DOS PLACAS	24,989.00		0.00		24,989.00	
12451025024001012	BALISTICAS NIVEL IV	24,989.00		0.00		24,989.00	
12451025024001013	CHALECO BALISTICO NIVEL IIIA CON DOS PLACAS	24,989.00		0.00		24,989.00	
12451025024001014	BALISTICAS NIVEL IV	24,989.00		0.00		24,989.00	
12451025024001015	CHALECO BALISTICO NIVEL IIIA CON DOS PLACAS	24,989.00		0.00		24,989.00	
12451025024001016	BALISTICAS NIVEL IV	24,989.00		0.00		24,989.00	
12451025024001017	CHALECO BALISTICO NIVEL IIIA CON DOS PLACAS	24,989.00		0.00		24,989.00	
12451025024001018	BALISTICAS NIVEL IV	24,989.00		0.00		24,989.00	
12451025024001019	CHALECO BALISTICO NIVEL IIIA CON DOS PLACAS	24,989.00		0.00		24,989.00	
12451025024001020	BALISTICAS NIVEL IV	24,989.00		0.00		24,989.00	
12451025024001021	CHALECO BALISTICO NIVEL IIIA CON DOS PLACAS	24,989.00		0.00		24,989.00	
12451025024001022	BALISTICAS NIVEL IV	24,989.00		0.00		24,989.00	
12451025024001023	CHALECO BALISTICO NIVEL IIIA CON DOS PLACAS	24,989.00		0.00		24,989.00	
12451025024001024	BALISTICAS NIVEL IV	24,989.00		0.00		24,989.00	
12451025024001025	CHALECO BALISTICO NIVEL IIIA CON DOS PLACAS	24,989.00		0.00		24,989.00	
12451025024001026	BALISTICAS NIVEL IV	24,989.00		0.00		24,989.00	
12451025024001027	CHALECO BALISTICO NIVEL IIIA CON DOS PLACAS	24,989.00		0.00		24,989.00	
12451025024001028	BALISTICAS NIVEL IV	24,989.00		0.00		24,989.00	
12451025024001029	CHALECO BALISTICO NIVEL IIIA CON DOS PLACAS	24,989.00		0.00		24,989.00	
12451025024001030	BALISTICAS NIVEL IV	24,989.00		0.00		24,989.00	
12451025024001031	CHALECO BALISTICO NIVEL IIIA CON DOS PLACAS	24,989.00		0.00		24,989.00	
12451025024001032	BALISTICAS NIVEL IV	24,989.00		0.00		24,989.00	
12451025024001033	CHALECO BALISTICO NIVEL IIIA CON DOS PLACAS	24,989.00		0.00		24,989.00	
12451025024001034	BALISTICAS NIVEL IV	24,989.00		0.00		24,989.00	
12451025024001035	CHALECO BALISTICO NIVEL IIIA CON DOS PLACAS	24,989.00		0.00		24,989.00	
12451025024001036	BALISTICAS NIVEL IV	24,989.00		0.00		24,989.00	
12451025024001037	CHALECO BALISTICO NIVEL IIIA CON DOS PLACAS	24,989.00		0.00		24,989.00	
12451025024001038	BALISTICAS NIVEL IV	24,989.00		0.00		24,989.00	
Coram/ Balanza	CHALECO BALISTICO NIVEL IIIA CON DOS PLACAS	24,989.00		0.00		24,989.00	

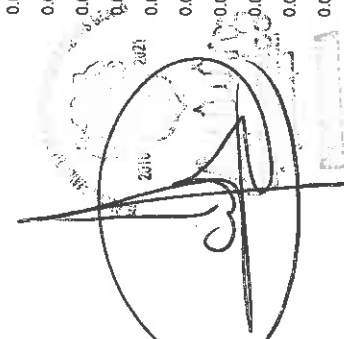

24,989.00 Ayuntamiento Municipal Coprocesal de Chilpancingo, Gro. CON TERCALONIA INTERNA Municipal



H. AYUNTAMIENTO MUNICIPAL DE CHILPANCINGO, GRO.

SECRETARIA DE FINANZAS Y ADMINISTRACION

CONSOLIDADO



BALANZA DE COMPROBACIÓN DEL 1 DE ENERO AL 31 DE DICIEMBRE DEL 2019

C U E N T A	C O N C E P T O	SALDOS INICIALES		MOVIMIENTOS		SALDOS ACUMULADOS	
		AL 1 DE ENERO DE 2019		ENERO - DICIEMBRE 2019		AL 31 DE DICIEMBRE DE 2019	
		DEBE	HABER	DEBE	HABER	DEBE	HABER
12451025024001039	BALISTICAS NIVEL IV			0.00	0.00	24,989.00	24,989.00
12451025024001040	CHALECO BALISTICO NIVEL IIIA CON DOS PLACAS			0.00	0.00	24,989.00	24,989.00
12451025024001041	BALISTICAS NIVEL IV			0.00	0.00	24,989.00	24,989.00
12451025024001042	CHALECO BALISTICO NIVEL IIIA CON DOS PLACAS			0.00	0.00	24,989.00	24,989.00
12451025024001043	BALISTICAS NIVEL IV			0.00	0.00	24,989.00	24,989.00
12451025024001044	CHALECO BALISTICO NIVEL IIIA CON DOS PLACAS			0.00	0.00	24,989.00	24,989.00
12451025024001045	BALISTICAS NIVEL IV			0.00	0.00	24,989.00	24,989.00
12451025024001046	CHALECO BALISTICO NIVEL IIIA CON DOS PLACAS			0.00	0.00	24,989.00	24,989.00
12451025024001047	BALISTICAS NIVEL IV			0.00	0.00	24,989.00	24,989.00
12451025024001048	CHALECO BALISTICO NIVEL IIIA CON DOS PLACAS			0.00	0.00	24,989.00	24,989.00
12451025024001049	BALISTICAS NIVEL IV			0.00	0.00	24,989.00	24,989.00
12451025024001050	CHALECO BALISTICO NIVEL IIIA CON DOS PLACAS			0.00	0.00	24,989.00	24,989.00
12451025024002	EQUIPO DE SEGURIDAD PUBLICA (CASCO TACTICOS)	69,400.02		0.00	0.00	69,400.02	69,400.02
12451025024002001	CASCO PARA MOTOCICLISTA LS2 DISEÑO 3/4	3,470.00		0.00	0.00	3,470.00	3,470.00
12451025024002002	COLOR NEGRO MATE	3,470.00		0.00	0.00	3,470.00	3,470.00
12451025024002003	CASCO PARA MOTOCICLISTA LS2 DISEÑO 3/4	3,470.00		0.00	0.00	3,470.00	3,470.00
12451025024002004	COLOR NEGRO MATE	3,470.00		0.00	0.00	3,470.00	3,470.00
12451025024002005	CASCO PARA MOTOCICLISTA LS2 DISEÑO 3/4	3,470.00		0.00	0.00	3,470.00	3,470.00
12451025024002006	COLOR NEGRO MATE	3,470.00		0.00	0.00	3,470.00	3,470.00
12451025024002007	CASCO PARA MOTOCICLISTA LS2 DISEÑO 3/4	3,470.00		0.00	0.00	3,470.00	3,470.00
12451025024002008	COLOR NEGRO MATE	3,470.00		0.00	0.00	3,470.00	3,470.00
12451025024002009	CASCO PARA MOTOCICLISTA LS2 DISEÑO 3/4	3,470.00		0.00	0.00	3,470.00	3,470.00
12451025024002010	COLOR NEGRO MATE	3,470.00		0.00	0.00	3,470.00	3,470.00
12451025024002011	CASCO PARA MOTOCICLISTA LS2 DISEÑO 3/4	3,470.00		0.00	0.00	3,470.00	3,470.00
12451025024002012	COLOR NEGRO MATE	3,470.00		0.00	0.00	3,470.00	3,470.00
12451025024002013	CASCO PARA MOTOCICLISTA LS2 DISEÑO 3/4	3,470.00		0.00	0.00	3,470.00	3,470.00
12451025024002014	COLOR NEGRO MATE	3,470.00		0.00	0.00	3,470.00	3,470.00
Coram/ Balanza		3,470.00		0.00	0.00	3,470.00	3,470.00

Handwritten signature and stamp

Official stamp of the Municipality of Chilpancingo

SECRETARIA MUNICIPAL DE FINANZAS Y ADMINISTRACION





H. AYUNTAMIENTO MUNICIPAL DE CHILPANCINGO, GRO.

SECRETARIA DE FINANZAS Y ADMINISTRACION

CONSOLIDADO



BALANZA DE COMPROBACIÓN DEL 1 DE ENERO AL 31 DE DICIEMBRE DEL 2019

C U E N T A	C O N C E P T O	SALDOS INICIALES		M O V I M I E N T O S		SALDOS ACUMULADOS	
		AL 1 DE ENERO DE 2019		ENERO - DICIEMBRE 2019		AL 31 DE DICIEMBRE DE 2019	
		DEBE	HABER	DEBE	HABER	DEBE	HABER
12451025024002015	CASCO PARA MOTOCICLISTA LS2 DISEÑO 3/4	3,470.00		0.00		3,470.00	
12451025024002016	COLOR NEGRO MATE	3,470.00		0.00		3,470.00	
12451025024002017	CASCO PARA MOTOCICLISTA LS2 DISEÑO 3/4	3,470.00		0.00		3,470.00	
12451025024002018	COLOR NEGRO MATE	3,470.00		0.00		3,470.00	
12451025024002019	CASCO PARA MOTOCICLISTA LS2 DISEÑO 3/4	3,470.00		0.00		3,470.00	
12451025024002020	COLOR NEGRO MATE	3,470.02		0.00		3,470.02	
12451025026	EJERCICIO FISCAL 2019	0.00		1,250,000.00		1,250,000.00	
12451025026002	EQUIPO DE SEGURIDAD (CHALECOS BALISTICOS)	0.00		1,250,000.00		1,250,000.00	
12451025026002001	CHALECO BALISTICO NIVEL III-A CON PLACAS BALISTICAS PARA ESCALAR A NIVEL IV 2	0.00		25,000.00		25,000.00	
12451025026002002	PANELES BALISTICOS DE ULTIMA TECNOLOGIA CON PROTECCION ADICIONAL (1)	0.00		25,000.00		25,000.00	
12451025026002003	CHALECO BALISTICO NIVEL III-A CON PLACAS BALISTICAS PARA ESCALAR A NIVEL IV 2	0.00		25,000.00		25,000.00	
12451025026002004	PANELES BALISTICOS DE ULTIMA TECNOLOGIA CON PROTECCION ADICIONAL (2)	0.00		25,000.00		25,000.00	
12451025026002005	CHALECO BALISTICO NIVEL III-A CON PLACAS BALISTICAS PARA ESCALAR A NIVEL IV 2	0.00		25,000.00		25,000.00	
12451025026002006	PANELES BALISTICOS DE ULTIMA TECNOLOGIA CON PROTECCION ADICIONAL (3)	0.00		25,000.00		25,000.00	
12451025026002007	CHALECO BALISTICO NIVEL III-A CON PLACAS BALISTICAS PARA ESCALAR A NIVEL IV 2	0.00		25,000.00		25,000.00	
12451025026002008	PANELES BALISTICOS DE ULTIMA TECNOLOGIA CON PROTECCION ADICIONAL (4)	0.00		25,000.00		25,000.00	
12451025026002009	CHALECO BALISTICO NIVEL III-A CON PLACAS BALISTICAS PARA ESCALAR A NIVEL IV 2	0.00		25,000.00		25,000.00	
12451025026002010	PANELES BALISTICOS DE ULTIMA TECNOLOGIA CON PROTECCION ADICIONAL (5)	0.00		25,000.00		25,000.00	
	CHALECO BALISTICO NIVEL III-A CON PLACAS BALISTICAS PARA ESCALAR A NIVEL IV 2	0.00		25,000.00		25,000.00	
	PANELES BALISTICOS DE ULTIMA TECNOLOGIA CON PROTECCION ADICIONAL (6)	0.00		25,000.00		25,000.00	
	CHALECO BALISTICO NIVEL III-A CON PLACAS BALISTICAS PARA ESCALAR A NIVEL IV 2	0.00		25,000.00		25,000.00	
	PANELES BALISTICOS DE ULTIMA TECNOLOGIA CON PROTECCION ADICIONAL (7)	0.00		25,000.00		25,000.00	
	CHALECO BALISTICO NIVEL III-A CON PLACAS BALISTICAS PARA ESCALAR A NIVEL IV 2	0.00		25,000.00		25,000.00	
	PANELES BALISTICOS DE ULTIMA TECNOLOGIA CON PROTECCION ADICIONAL (8)	0.00		25,000.00		25,000.00	
	CHALECO BALISTICO NIVEL III-A CON PLACAS BALISTICAS PARA ESCALAR A NIVEL IV 2	0.00		25,000.00		25,000.00	
	PANELES BALISTICOS DE ULTIMA TECNOLOGIA CON PROTECCION ADICIONAL (9)	0.00		25,000.00		25,000.00	
	CHALECO BALISTICO NIVEL III-A CON PLACAS BALISTICAS PARA ESCALAR A NIVEL IV 2	0.00		25,000.00		25,000.00	

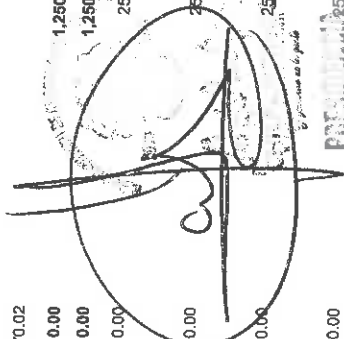

H. Ayuntamiento Municipal de Chilpancingo, Gro.  
 SECRETARIA DE FINANZAS Y ADMINISTRACION  
 CONTRALORIA INTERNA





H. AYUNTAMIENTO MUNICIPAL DE CHILPANCINGO, GRO.

SECRETARIA DE FINANZAS Y ADMINISTRACION

CONSOLIDADO



BALANZA DE COMPROBACION DEL 1 DE ENERO AL 31 DE DICIEMBRE DEL 2019

C U E N T A	C O N C E P T O	SALDOS INICIALES		MOVIMIENTOS		SALDOS ACUMULADOS	
		AL 1 DE ENERO DE 2019		ENERO - DICIEMBRE 2019		AL 31 DE DICIEMBRE DE 2019	
		DEBE	HABER	DEBE	HABER	DEBE	HABER
12451025026002011	PANELES BALISTICOS DE ULTIMA TECNOLOGIA CON PROTECCION ADICIONAL. (10)	0.00		25,000.00	0.00	25,000.00	
12451025026002012	CHALECO BALISTICO NIVEL III-A CON PLACAS BALISTICAS PARA ESCALAR A NIVEL IV 2	0.00		25,000.00	0.00	25,000.00	
12451025026002013	PANELES BALISTICOS DE ULTIMA TECNOLOGIA CON PROTECCION ADICIONAL. (11)	0.00		25,000.00	0.00	25,000.00	
12451025026002014	CHALECO BALISTICO NIVEL III-A CON PLACAS BALISTICAS PARA ESCALAR A NIVEL IV 2	0.00		25,000.00	0.00	25,000.00	
12451025026002015	PANELES BALISTICOS DE ULTIMA TECNOLOGIA CON PROTECCION ADICIONAL. (12)	0.00		25,000.00	0.00	25,000.00	
12451025026002016	CHALECO BALISTICO NIVEL III-A CON PLACAS BALISTICAS PARA ESCALAR A NIVEL IV 2	0.00		25,000.00	0.00	25,000.00	
12451025026002017	PANELES BALISTICOS DE ULTIMA TECNOLOGIA CON PROTECCION ADICIONAL. (13)	0.00		25,000.00	0.00	25,000.00	
12451025026002018	CHALECO BALISTICO NIVEL III-A CON PLACAS BALISTICAS PARA ESCALAR A NIVEL IV 2	0.00		25,000.00	0.00	25,000.00	
12451025026002019	PANELES BALISTICOS DE ULTIMA TECNOLOGIA CON PROTECCION ADICIONAL. (14)	0.00		25,000.00	0.00	25,000.00	
12451025026002020	CHALECO BALISTICO NIVEL III-A CON PLACAS BALISTICAS PARA ESCALAR A NIVEL IV 2	0.00		25,000.00	0.00	25,000.00	
12451025026002021	PANELES BALISTICOS DE ULTIMA TECNOLOGIA CON PROTECCION ADICIONAL. (15)	0.00		25,000.00	0.00	25,000.00	
12451025026002022	CHALECO BALISTICO NIVEL III-A CON PLACAS BALISTICAS PARA ESCALAR A NIVEL IV 2	0.00		25,000.00	0.00	25,000.00	
12451025026002023	PANELES BALISTICOS DE ULTIMA TECNOLOGIA CON PROTECCION ADICIONAL. (16)	0.00		25,000.00	0.00	25,000.00	
	CHALECO BALISTICO NIVEL III-A CON PLACAS BALISTICAS PARA ESCALAR A NIVEL IV 2	0.00		25,000.00	0.00	25,000.00	
	PANELES BALISTICOS DE ULTIMA TECNOLOGIA CON PROTECCION ADICIONAL. (17)	0.00		25,000.00	0.00	25,000.00	
	CHALECO BALISTICO NIVEL III-A CON PLACAS BALISTICAS PARA ESCALAR A NIVEL IV 2	0.00		25,000.00	0.00	25,000.00	
	PANELES BALISTICOS DE ULTIMA TECNOLOGIA CON PROTECCION ADICIONAL. (18)	0.00		25,000.00	0.00	25,000.00	
	CHALECO BALISTICO NIVEL III-A CON PLACAS BALISTICAS PARA ESCALAR A NIVEL IV 2	0.00		25,000.00	0.00	25,000.00	
	PANELES BALISTICOS DE ULTIMA TECNOLOGIA CON PROTECCION ADICIONAL. (19)	0.00		25,000.00	0.00	25,000.00	
	CHALECO BALISTICO NIVEL III-A CON PLACAS BALISTICAS PARA ESCALAR A NIVEL IV 2	0.00		25,000.00	0.00	25,000.00	
	PANELES BALISTICOS DE ULTIMA TECNOLOGIA CON PROTECCION ADICIONAL. (20)	0.00		25,000.00	0.00	25,000.00	
	CHALECO BALISTICO NIVEL III-A CON PLACAS BALISTICAS PARA ESCALAR A NIVEL IV 2	0.00		25,000.00	0.00	25,000.00	
	PANELES BALISTICOS DE ULTIMA TECNOLOGIA CON PROTECCION ADICIONAL. (21)	0.00		25,000.00	0.00	25,000.00	
	CHALECO BALISTICO NIVEL III-A CON PLACAS BALISTICAS PARA ESCALAR A NIVEL IV 2	0.00		25,000.00	0.00	25,000.00	
	PANELES BALISTICOS DE ULTIMA TECNOLOGIA CON PROTECCION ADICIONAL. (22)	0.00		25,000.00	0.00	25,000.00	
	CHALECO BALISTICO NIVEL III-A CON PLACAS BALISTICAS PARA ESCALAR A NIVEL IV 2	0.00		25,000.00	0.00	25,000.00	
	PANELES BALISTICOS DE ULTIMA TECNOLOGIA CON PROTECCION ADICIONAL. (23)	0.00		25,000.00	0.00	25,000.00	
	CHALECO BALISTICO NIVEL III-A CON PLACAS BALISTICAS PARA ESCALAR A NIVEL IV 2	0.00		25,000.00	0.00	25,000.00	

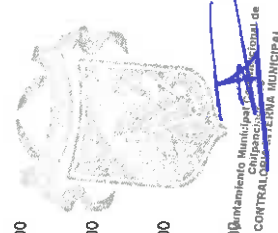
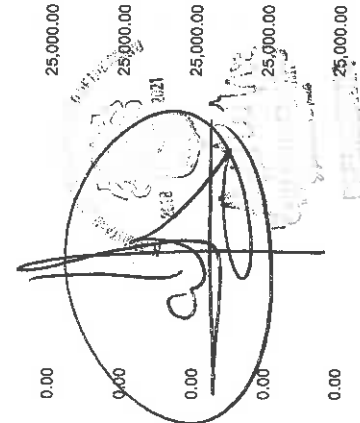



H. AYUNTAMIENTO MUNICIPAL DE CHILPANCINGO, GRO.

SECRETARIA DE FINANZAS Y ADMINISTRACION

CONSOLIDADO



BALANZA DE COMPROBACION DEL 1 DE ENERO AL 31 DE DICIEMBRE DEL 2019

C U E N T A	C O N C E P T O	SALDOS INICIALES		M O V I M I E N T O S		SALDOS ACUMULADOS	
		AL 1 DE ENERO DE 2019		ENERO - DICIEMBRE 2019		AL 31 DE DICIEMBRE DE 2019	
		DEBE	HABER	DEBE	HABER	DEBE	HABER
12451025026002024	CON PROTECCION ADICIONAL. (23) CHALECO BALISTICO NIVEL III-A CON PLACAS PANELES BALISTICOS PARA ESCALAR A NIVEL IV 2 CON PROTECCION ADICIONAL. (24) CHALECO BALISTICO NIVEL III-A CON PLACAS PANELES BALISTICOS PARA ESCALAR A NIVEL IV 2 CON PROTECCION ADICIONAL. (25) CHALECO BALISTICO NIVEL III-A CON PLACAS PANELES BALISTICOS PARA ESCALAR A NIVEL IV 2 CON PROTECCION ADICIONAL. (26) CHALECO BALISTICO NIVEL III-A CON PLACAS PANELES BALISTICOS PARA ESCALAR A NIVEL IV 2 CON PROTECCION ADICIONAL. (27) CHALECO BALISTICO NIVEL III-A CON PLACAS PANELES BALISTICOS PARA ESCALAR A NIVEL IV 2 CON PROTECCION ADICIONAL. (28) CHALECO BALISTICO NIVEL III-A CON PLACAS PANELES BALISTICOS PARA ESCALAR A NIVEL IV 2 CON PROTECCION ADICIONAL. (29) CHALECO BALISTICO NIVEL III-A CON PLACAS PANELES BALISTICOS PARA ESCALAR A NIVEL IV 2 CON PROTECCION ADICIONAL. (30) CHALECO BALISTICO NIVEL III-A CON PLACAS PANELES BALISTICOS PARA ESCALAR A NIVEL IV 2 CON PROTECCION ADICIONAL. (31) CHALECO BALISTICO NIVEL III-A CON PLACAS PANELES BALISTICOS PARA ESCALAR A NIVEL IV 2 CON PROTECCION ADICIONAL. (32) CHALECO BALISTICO NIVEL III-A CON PLACAS PANELES BALISTICOS PARA ESCALAR A NIVEL IV 2 CON PROTECCION ADICIONAL. (33) CHALECO BALISTICO NIVEL III-A CON PLACAS PANELES BALISTICOS PARA ESCALAR A NIVEL IV 2 CON PROTECCION ADICIONAL. (34) CHALECO BALISTICO NIVEL III-A CON PLACAS PANELES BALISTICOS PARA ESCALAR A NIVEL IV 2 CON PROTECCION ADICIONAL. (35) CHALECO BALISTICO NIVEL III-A CON PLACAS PANELES BALISTICOS PARA ESCALAR A NIVEL IV 2 CON PROTECCION ADICIONAL. (36)	0.00	0.00	25,000.00	0.00	25,000.00	0.00
12451025026002025		0.00	0.00	25,000.00	0.00	25,000.00	0.00
12451025026002026		0.00	0.00	25,000.00	0.00	25,000.00	0.00
12451025026002027		0.00	0.00	25,000.00	0.00	25,000.00	0.00
12451025026002028		0.00	0.00	25,000.00	0.00	25,000.00	0.00
12451025026002029		0.00	0.00	25,000.00	0.00	25,000.00	0.00
12451025026002030		0.00	0.00	25,000.00	0.00	25,000.00	0.00
12451025026002031		0.00	0.00	25,000.00	0.00	25,000.00	0.00
12451025026002032		0.00	0.00	25,000.00	0.00	25,000.00	0.00
12451025026002033		0.00	0.00	25,000.00	0.00	25,000.00	0.00
12451025026002034		0.00	0.00	25,000.00	0.00	25,000.00	0.00
12451025026002035		0.00	0.00	25,000.00	0.00	25,000.00	0.00
12451025026002036		0.00	0.00	25,000.00	0.00	25,000.00	0.00

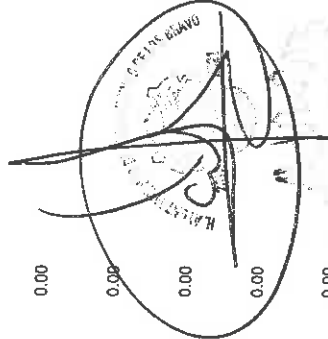

M. Ayuntamiento Chilpancingo, Gro. Concejal Municipal  
CDM P. Paloma Inter Municipal



H. AYUNTAMIENTO MUNICIPAL DE CHILPANCINGO, GRO.

SECRETARIA DE FINANZAS Y ADMINISTRACION

CONSOLIDADO



BALANZA DE COMPROBACION DEL 1 DE ENERO AL 31 DE DICIEMBRE DEL 2019

C U E N T A	C O N C E P T O	SALDOS INICIALES		M O V I M I E N T O S		SALDOS ACUMULADOS	
		AL 1 DE ENERO DE 2019		ENERO - DICIEMBRE 2019		AL 31 DE DICIEMBRE DE 2019	
		DEBE	HABER	DEBE	HABER	DEBE	HABER
1 2 4 5 1 0 2 5 0 2 6 0 0 2 0 3 7	CHALECO BALISTICO NIVEL III-A CON PLACAS BALISTICAS PARA ESCALAR A NIVEL IV 2	0.00		25,000.00	0.00	25,000.00	
1 2 4 5 1 0 2 5 0 2 6 0 0 2 0 3 8	PANELES BALISTICOS DE ULTIMA TECNOLOGIA CON PROTECCION ADICIONAL (37)	0.00		25,000.00	0.00	25,000.00	
1 2 4 5 1 0 2 5 0 2 6 0 0 2 0 3 9	CHALECO BALISTICO NIVEL III-A CON PLACAS BALISTICAS PARA ESCALAR A NIVEL IV 2	0.00		25,000.00	0.00	25,000.00	
1 2 4 5 1 0 2 5 0 2 6 0 0 2 0 4 0	PANELES BALISTICOS DE ULTIMA TECNOLOGIA CON PROTECCION ADICIONAL (38)	0.00		25,000.00	0.00	25,000.00	
1 2 4 5 1 0 2 5 0 2 6 0 0 2 0 4 1	CHALECO BALISTICO NIVEL III-A CON PLACAS BALISTICAS PARA ESCALAR A NIVEL IV 2	0.00		25,000.00	0.00	25,000.00	
1 2 4 5 1 0 2 5 0 2 6 0 0 2 0 4 2	PANELES BALISTICOS DE ULTIMA TECNOLOGIA CON PROTECCION ADICIONAL (40)	0.00		25,000.00	0.00	25,000.00	
1 2 4 5 1 0 2 5 0 2 6 0 0 2 0 4 3	CHALECO BALISTICO NIVEL III-A CON PLACAS BALISTICAS PARA ESCALAR A NIVEL IV 2	0.00		25,000.00	0.00	25,000.00	
1 2 4 5 1 0 2 5 0 2 6 0 0 2 0 4 4	PANELES BALISTICOS DE ULTIMA TECNOLOGIA CON PROTECCION ADICIONAL (42)	0.00		25,000.00	0.00	25,000.00	
1 2 4 5 1 0 2 5 0 2 6 0 0 2 0 4 5	CHALECO BALISTICO NIVEL III-A CON PLACAS BALISTICAS PARA ESCALAR A NIVEL IV 2	0.00		25,000.00	0.00	25,000.00	
1 2 4 5 1 0 2 5 0 2 6 0 0 2 0 4 6	PANELES BALISTICOS DE ULTIMA TECNOLOGIA CON PROTECCION ADICIONAL (43)	0.00		25,000.00	0.00	25,000.00	
1 2 4 5 1 0 2 5 0 2 6 0 0 2 0 4 7	CHALECO BALISTICO NIVEL III-A CON PLACAS BALISTICAS PARA ESCALAR A NIVEL IV 2	0.00		25,000.00	0.00	25,000.00	
1 2 4 5 1 0 2 5 0 2 6 0 0 2 0 4 8	PANELES BALISTICOS DE ULTIMA TECNOLOGIA CON PROTECCION ADICIONAL (44)	0.00		25,000.00	0.00	25,000.00	
1 2 4 5 1 0 2 5 0 2 6 0 0 2 0 4 9	CHALECO BALISTICO NIVEL III-A CON PLACAS BALISTICAS PARA ESCALAR A NIVEL IV 2	0.00		25,000.00	0.00	25,000.00	
1 2 4 5 1 0 2 5 0 2 6 0 0 2 0 5 0	PANELES BALISTICOS DE ULTIMA TECNOLOGIA CON PROTECCION ADICIONAL (46)	0.00		25,000.00	0.00	25,000.00	
	CHALECO BALISTICO NIVEL III-A CON PLACAS BALISTICAS PARA ESCALAR A NIVEL IV 2	0.00		25,000.00	0.00	25,000.00	
	PANELES BALISTICOS DE ULTIMA TECNOLOGIA CON PROTECCION ADICIONAL (47)	0.00		25,000.00	0.00	25,000.00	
	CHALECO BALISTICO NIVEL III-A CON PLACAS BALISTICAS PARA ESCALAR A NIVEL IV 2	0.00		25,000.00	0.00	25,000.00	
	PANELES BALISTICOS DE ULTIMA TECNOLOGIA CON PROTECCION ADICIONAL (48)	0.00		25,000.00	0.00	25,000.00	
	CHALECO BALISTICO NIVEL III-A CON PLACAS BALISTICAS PARA ESCALAR A NIVEL IV 2	0.00		25,000.00	0.00	25,000.00	
	PANELES BALISTICOS DE ULTIMA TECNOLOGIA CON PROTECCION ADICIONAL (49)	0.00		25,000.00	0.00	25,000.00	
	CHALECO BALISTICO NIVEL III-A CON PLACAS	0.00		25,000.00	0.00	25,000.00	

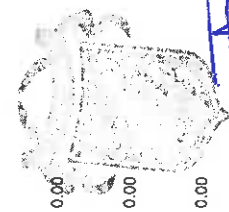
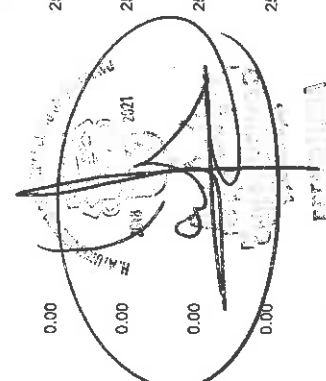

El Ayuntamiento Municipal de Chilpancingo, Gro. a cargo de la Secretaria de Finanzas y Administracion



H. AYUNTAMIENTO MUNICIPAL DE CHILPANCINGO, GRO.

SECRETARIA DE FINANZAS Y ADMINISTRACION

CONSOLIDADO



BALANZA DE COMPROBACIÓN DEL 1 DE ENERO AL 31 DE DICIEMBRE DEL 2019

C U E N T A	C O N C E P T O	SALDOS INICIALES		MOVIMIENTOS		SALDOS ACUMULADOS	
		AL 1 DE ENERO DE 2019		ENERO - DICIEMBRE 2019		AL 31 DE DICIEMBRE DE 2019	
		DEBE	HABER	DEBE	HABER	DEBE	HABER
1248	BALISTICAS PARA ESCALAR A NIVEL IV 2	10,716,604.78		679,240.00		11,395,844.78	
12481	PANELES BALISTICOS DE ULTIMA TECNOLOGIA CON PROTECCION ADICIONAL. (50)	1,593,421.46		0.00		1,593,421.46	
12461001	MAQUINARIA, OTROS EQUIPOS Y HERRAMIENTAS	1,571,201.46		0.00		1,571,201.46	
12461001004	MAQUINARIA Y EQUIPO AGROPECUARIO	1,571,201.46		0.00		1,571,201.46	
12461003	GASTO CORRIENTE	1,571,201.46		0.00		1,571,201.46	
12461003004	ADMON 2008-2012	22,220.00		0.00		22,220.00	
12461003004001	MAQUINARIA Y EQUIPO AGROPECUARIO	22,220.00		0.00		22,220.00	
12463	FONDO DE APORT P/IFORT DE LOS MPIO	22,220.00		0.00		22,220.00	
12463001	ADMON 2009 - 2012	1,073,481.34		0.00		1,073,481.34	
12463001004	MAQUINARIA Y EQUIPO AGROPECUARIO	34,923.57		0.00		34,923.57	
12463002	GASTO CORRIENTE	34,923.57		0.00		34,923.57	
12463002005	ADMON 2009-2012	34,923.57		0.00		34,923.57	
12463002005001	MAQUINARIA Y EQUIPO DE CONSTRUCCION	95,230.00		0.00		95,230.00	
12463002005001001	FONDO DE APORT P/INFRA SOC MPAL	95,230.00		0.00		95,230.00	
12463003	ADMON 2012-2015	95,230.00		0.00		95,230.00	
12463003005	MAQUINARIA Y EQUIPO DE CONSTRUCCION	95,230.00		0.00		95,230.00	
12463003005001	FONDO DE APORT P/IFORT DE LOS MPIO	943,327.77		0.00		943,327.77	
12463003005001001	ADMON 2012-2015	943,327.77		0.00		943,327.77	
12464	MAQUINARIA Y EQUIPO DE CONSTRUCCION	943,327.77		0.00		943,327.77	
12464001	SISTEMAS DE AIRE ACONDICIONADO, CALEFACCION Y DE REFRIGERACION INDUSTRIAL Y COMERCIAL	257,767.29		0.00		257,767.29	
12464001004	GASTO CORRIENTE	38,074.98		0.00		38,074.98	
12464001004001	ADMON 2009-2012	38,074.98		0.00		38,074.98	
12464003	SISTEMA DE AIRE ACONDICIONADO, CALEFACCION Y DE REFRIGERACION	38,074.98		0.00		38,074.98	
12464003005	FONDO DE APORT P/IFORT DE LOS MPIO	2,499.00		0.00		2,499.00	
12464003005001	ADMON 2012-2015	2,499.00		0.00		2,499.00	
12464021	SISTEMAS DE AIRE ACONDICIONADO, CALEFACCION Y DE REFRIGERACION INDUSTRIAL Y COMERCIAL	2,499.00		0.00		2,499.00	
12464021001	GASTO CORRIENTE	14,193.31		0.00		14,193.31	
12464021001001	EJERCICIO 2016	14,193.31		0.00		14,193.31	
12464021001001001	SISTEMAS DE AIRE ACONDICIONADO, CALEFACCION Y DE REFRIGERACION INDUSTRIAL Y COMERCIAL	14,193.31		0.00		14,193.31	

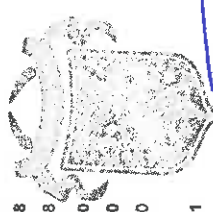
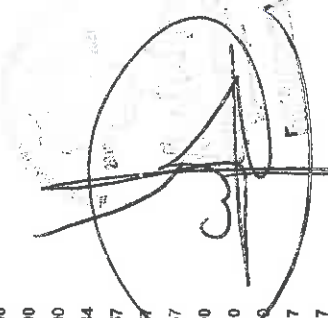

Secretaria de Finanzas y Administración  
Ayuntamiento Municipal de Chilpancingo, Gro.  
CENTRALORIA ADMINISTRATIVA MUNICIPAL



H. AYUNTAMIENTO MUNICIPAL DE CHILPANCINGO, GRO.

SECRETARIA DE FINANZAS Y ADMINISTRACION

CONSOLIDADO



BALANZA DE COMPROBACION DEL 1 DE ENERO AL 31 DE DICIEMBRE DEL 2019

C U E N T A	C O N C E P T O	SALDOS INICIALES		M O V I M I E N T O S		SALDOS ACUMULADOS	
		AL 1 DE ENERO DE 2019		ENERO - DICIEMBRE 2019		AL 31 DE DICIEMBRE DE 2019	
		DEBE	HABER	DEBE	HABER	DEBE	HABER
12464022	FONDO PARA LA INFRAESTRUCTURA SOCIAL DE LOS MUNICIPIOS (FAISM)	203,000.00		0.00		203,000.00	
12464022022	EJERCICIO 2017	203,000.00		0.00		203,000.00	
12464022001	SISTEMAS DE AIRE ACONDICIONADO	203,000.00		0.00		203,000.00	
12464022001001	EQUIPO DE AIRE ACONDICIONADO TIPO HIGH WALL 2 TNO SOLO FRIO MARCA MIRAGE MODELO X2	20,300.00		0.00		20,300.00	
12464022001002	EQUIPO DE AIRE ACONDICIONADO TIPO HIGH WALL 2 TNO SOLO FRIO MARCA MIRAGE MODELO X2	20,300.00		0.00		20,300.00	
12464022001003	EQUIPO DE AIRE ACONDICIONADO TIPO HIGH WALL 2 TNO SOLO FRIO MARCA MIRAGE MODELO X2	20,300.00		0.00		20,300.00	
12464022001004	EQUIPO DE AIRE ACONDICIONADO TIPO HIGH WALL 2 TNO SOLO FRIO MARCA MIRAGE MODELO X2	20,300.00		0.00		20,300.00	
12464022001005	EQUIPO DE AIRE ACONDICIONADO TIPO HIGH WALL 2 TNO SOLO FRIO MARCA MIRAGE MODELO X2	20,300.00		0.00		20,300.00	
12464022001006	EQUIPO DE AIRE ACONDICIONADO TIPO HIGH WALL 2 TNO SOLO FRIO MARCA MIRAGE MODELO X2	20,300.00		0.00		20,300.00	
12464022001007	EQUIPO DE AIRE ACONDICIONADO TIPO HIGH WALL 2 TNO SOLO FRIO MARCA MIRAGE MODELO X2	20,300.00		0.00		20,300.00	
12464022001008	EQUIPO DE AIRE ACONDICIONADO TIPO HIGH WALL 2 TNO SOLO FRIO MARCA MIRAGE MODELO X2	20,300.00		0.00		20,300.00	
12464022001009	EQUIPO DE AIRE ACONDICIONADO TIPO HIGH WALL 2 TNO SOLO FRIO MARCA MIRAGE MODELO X2	20,300.00		0.00		20,300.00	
12464022001010	EQUIPO DE AIRE ACONDICIONADO TIPO HIGH WALL 2 TNO SOLO FRIO MARCA MIRAGE MODELO X2	20,300.00		0.00		20,300.00	
12465	EQUIPO DE COMUNICACION Y TELECOMUNICACION	5,046,743.13		595,000.00		5,641,743.13	
12465001	GASTO CORRIENTE	466,586.14		0.00		466,586.14	
12465001004	ADMON 2009-2012	417,910.64		0.00		417,910.64	
12465001004001	EQUIPO DE COMUNICACION Y TELECOMUNICACIONES	417,910.64		0.00		417,910.64	
12465001008	ADMON 2016-2021	48,675.50		0.00		48,675.50	
12465001008001	EQUIPO DE COMUNICACION Y TELECOMUNICACIONES	48,675.50		0.00		48,675.50	
12465001008001001	7 RADIO PORTATIL DIGITAL MARCA KENWOOD NX340 450-520MHZ MODO DIGITAL O ANALOGICO TRONCALIZABLE DIGITAL, INCLUYE BATERIA ANTENA CARGADOR Y CLIP CON No DE SERIE B8612761, B8612762, B8612763, B8612764, B8612765, B7612769, B8612770	48,675.50		0.00		48,675.50	
12465002	FONDO DE APORT PIMFRA SOC MPAL	5,650.00		0.00		5,650.00	

SECRETARIA DE FINANZAS Y ADMINISTRACION  
 H. AYUNTAMIENTO MUNICIPAL DE CHILPANCINGO, GRO.  
 CONTRALORIA INTERNA MUNICIPAL  
 2019







H. AYUNTAMIENTO MUNICIPAL DE CHILPANCINGO, GRO.

SECRETARIA DE FINANZAS Y ADMINISTRACION

CONSOLIDADO



BALANZA DE COMPROBACION DEL 1 DE ENERO AL 31 DE DICIEMBRE DEL 2019

C U E N T A	C O N C E P T O	SALDOS INICIALES		M O V I M I E N T O S		SALDOS ACUMULADOS	
		AL 1 DE ENERO DE 2019		ENERO - DICIEMBRE 2019		AL 31 DE DICIEMBRE DE 2019	
		DEBE	HABER	DEBE	HABER	DEBE	HABER
12465025022002	EQUIPOS Y APARATOS DE COMUNICACIONES	234,366.40		0.00		234,366.40	
12465025022001	(TERMINAL DIGITAL PORTATIL (RADIO) TETRAPOL	29,295.80		0.00		29,295.80	
	TPM700, TRANSMISOR 10W, SENSIBILIDAD						
	ESTATICADINAMICA MEJOR QUE-119 DBW-111						
	DNM.						
12465025022002	TERMINAL DIGITAL PORTATIL (RADIO) TETRAPOL	29,295.80		0.00		29,295.80	
	TPM700, TRANSMISOR 10W, SENSIBILIDAD						
	ESTATICADINAMICA MEJOR QUE-119 DBW-111						
	DNM.						
12465025022003	TERMINAL DIGITAL PORTATIL (RADIO) TETRAPOL	29,295.80		0.00		29,295.80	
	TPM700, TRANSMISOR 10W, SENSIBILIDAD						
	ESTATICADINAMICA MEJOR QUE-119 DBW-111						
	DNM.						
12465025022004	TERMINAL DIGITAL PORTATIL (RADIO) TETRAPOL	29,295.80		0.00		29,295.80	
	TPM700, TRANSMISOR 10W, SENSIBILIDAD						
	ESTATICADINAMICA MEJOR QUE-119 DBW-111						
	DNM.						
12465025022005	TERMINAL DIGITAL PORTATIL (RADIO) TETRAPOL	29,295.80		0.00		29,295.80	
	TPM700, TRANSMISOR 10W, SENSIBILIDAD						
	ESTATICADINAMICA MEJOR QUE-119 DBW-111						
	DNM.						
12465025022006	TERMINAL DIGITAL PORTATIL (RADIO) TETRAPOL	29,295.80		0.00		29,295.80	
	TPM700, TRANSMISOR 10W, SENSIBILIDAD						
	ESTATICADINAMICA MEJOR QUE-119 DBW-111						
	DNM.						
12465025022002	TERMINAL DIGITAL PORTATIL (RADIO) TETRAPOL	29,295.80		0.00		29,295.80	
	TPM700, TRANSMISOR 10W, SENSIBILIDAD						
	ESTATICADINAMICA MEJOR QUE-119 DBW-111						
	DNM.						
12465025022002	TERMINAL DIGITAL PORTATIL (RADIO) TETRAPOL	29,295.80		0.00		29,295.80	
	TPM700, TRANSMISOR 10W, SENSIBILIDAD						
	ESTATICADINAMICA MEJOR QUE-119 DBW-111						
	DNM.						
12465025022002	TERMINAL DIGITAL PORTATIL (RADIO) TETRAPOL	29,295.80		0.00		29,295.80	
	TPM700, TRANSMISOR 10W, SENSIBILIDAD						
	ESTATICADINAMICA MEJOR QUE-119 DBW-111						
	DNM.						
12465025024001	EJERCICIO 2018	600,000.00		0.00		600,000.00	
12465025024001	EQUIPOS Y APARATOS DE COMUNICACIONES	600,000.00		0.00		600,000.00	
	(TERMINAL DIGITAL MOVIL (RADIO) TETRAPOL,						
	BANDAS DE FRECUENCIA 380-430 MHZ Y						
	TRANSMISOR 10W (1)						
	TERMINAL DIGITAL MOVIL (RADIO) TETRAPOL,						
	BANDAS DE FRECUENCIA 380-430 MHZ Y						
	TRANSMISOR 10W (2)						
	TERMINAL DIGITAL MOVIL (RADIO) TETRAPOL,						
	BANDAS DE FRECUENCIA 380-430 MHZ Y						
	TRANSMISOR 10W (3)						
	TERMINAL DIGITAL MOVIL (RADIO) TETRAPOL,						
	BANDAS DE FRECUENCIA 380-430 MHZ Y						
	TRANSMISOR 10W (4)						
	TERMINAL DIGITAL MOVIL (RADIO) TETRAPOL,						
	BANDAS DE FRECUENCIA 380-430 MHZ Y						
	TRANSMISOR 10W (5)						
12465025024002	TERMINAL DIGITAL MOVIL (RADIO) TETRAPOL,	75,000.00		0.00		75,000.00	
	BANDAS DE FRECUENCIA 380-430 MHZ Y						
	TRANSMISOR 10W (1)						
12465025024001	TERMINAL DIGITAL MOVIL (RADIO) TETRAPOL,	75,000.00		0.00		75,000.00	
	BANDAS DE FRECUENCIA 380-430 MHZ Y						
	TRANSMISOR 10W (2)						
12465025024001	TERMINAL DIGITAL MOVIL (RADIO) TETRAPOL,	75,000.00		0.00		75,000.00	
	BANDAS DE FRECUENCIA 380-430 MHZ Y						
	TRANSMISOR 10W (3)						
12465025024001	TERMINAL DIGITAL MOVIL (RADIO) TETRAPOL,	75,000.00		0.00		75,000.00	
	BANDAS DE FRECUENCIA 380-430 MHZ Y						
	TRANSMISOR 10W (4)						
12465025024001	TERMINAL DIGITAL MOVIL (RADIO) TETRAPOL,	75,000.00		0.00		75,000.00	
	BANDAS DE FRECUENCIA 380-430 MHZ Y						
	TRANSMISOR 10W (5)						
12465025024001	TERMINAL DIGITAL MOVIL (RADIO) TETRAPOL,	75,000.00		0.00		75,000.00	
	BANDAS DE FRECUENCIA 380-430 MHZ Y						
	TRANSMISOR 10W (5)						
Corram/ Balanza		75,000.00		0.00		75,000.00	

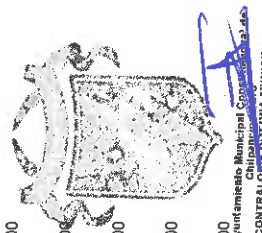
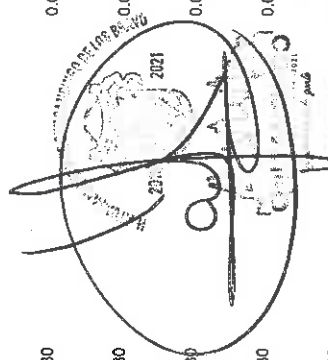



H. AYUNTAMIENTO MUNICIPAL DE CHILPANCINGO, GRO.

SECRETARIA DE FINANZAS Y ADMINISTRACION

CONSOLIDADO



BALANZA DE COMPROBACION DEL 1 DE ENERO AL 31 DE DICIEMBRE DEL 2019

C U E N T A	C O N C E P T O	SALDOS INICIALES		M O V I M I E N T O S		SALDOS ACUMULADOS	
		AL 1 DE ENERO DE 2019		ENERO - DICIEMBRE 2019		AL 31 DE DICIEMBRE DE 2019	
		DEBE	HABER	DEBE	HABER	DEBE	HABER
12465025024001007	BANDAS DE FRECUENCIA 380-430 MHZ Y TRANSMISOR 10W. (6)	75,000.00		0.00	0.00	75,000.00	
12465025024001008	TERMINAL DIGITAL MOVIL (RADIO) TETRAPOL, BANDAS DE FRECUENCIA 380-430 MHZ Y TRANSMISOR 10W. (7)	75,000.00		0.00	0.00	75,000.00	
12465025026	TERMINAL DIGITAL MOVIL (RADIO) TETRAPOL, BANDAS DE FRECUENCIA 380-430 MHZ Y TRANSMISOR 10W. (8)						
12465025026001	EJERCICIO 2019	0.00		595,000.00	0.00	595,000.00	
12465025026001001	EQUIPOS Y APARATOS DE COMUNICACIONES Y TELECOMUNICACIONES	0.00		595,000.00	0.00	595,000.00	
12465025026001002	TERMINAL DIGITAL MOVIL RADIO (1)	0.00		85,000.00	0.00	85,000.00	
12465025026001003	TERMINAL DIGITAL MOVIL RADIO (2)	0.00		85,000.00	0.00	85,000.00	
12465025026001004	TERMINAL DIGITAL MOVIL RADIO (3)	0.00		85,000.00	0.00	85,000.00	
12465025026001005	TERMINAL DIGITAL MOVIL RADIO (4)	0.00		85,000.00	0.00	85,000.00	
12465025026001006	TERMINAL DIGITAL MOVIL RADIO (5)	0.00		85,000.00	0.00	85,000.00	
12465025026001007	TERMINAL DIGITAL MOVIL RADIO (6)	0.00		85,000.00	0.00	85,000.00	
12466	TERMINAL DIGITAL MOVIL RADIO (7)	0.00		85,000.00	0.00	85,000.00	
12466001	EQUIPOS DE GENERACION ELÉCTRICA, APARATOS Y ACCESORIOS ELÉCTRICOS	28,512.42		0.00	0.00	28,512.42	
12466001004	GASTO CORRIENTE	28,512.42		0.00	0.00	28,512.42	
124660010040001	ADMON 2009-2012	28,512.42		0.00	0.00	28,512.42	
12467	EQUIPOS DE GENERACION ELÉCTRICA, APARATOS Y ACCESORIOS ELÉCTRICOS	28,512.42		0.00	0.00	28,512.42	
12467001	HERRAMIENTAS Y MAQUINAS-HERRAMIENTA	791,788.39		37,260.00	0.00	829,048.39	
12467001005	GASTO CORRIENTE	289,125.10		0.00	0.00	289,125.10	
12467001005001	ADMON 2012 - 2015	289,125.10		0.00	0.00	289,125.10	
12467003	HERRAMIENTAS Y MAQUINAS HERRAMIENTA	289,125.10		0.00	0.00	289,125.10	
12467003005	FONDO DE APORT PIFORT DE LOS NIPOS	18,140.54		0.00	0.00	18,140.54	
12467003005001	ADMON 2012-2015	18,140.54		0.00	0.00	18,140.54	
12467021	HERRAMIENTAS Y MAQUINARIAS HERRAMIENTAS	18,140.54		0.00	0.00	18,140.54	
12467021020	GASTO CORRIENTE	168,014.75		0.00	0.00	168,014.75	
12467021020001	ADMON 2015 - 2018	29,177.05		0.00	0.00	29,177.05	
12467021021	HERRAMIENTAS Y MAQUINAS HERRAMIENTA	29,177.05		0.00	0.00	29,177.05	
12467021021001	EJERCICIO 2016	81,973.02		0.00	0.00	81,973.02	
12467021022	HERRAMIENTAS Y MAQUINAS HERRAMIENTA	81,973.02		0.00	0.00	81,973.02	
12467021022001	EJERCICIO 2017	56,864.68		0.00	0.00	56,864.68	
	HERRAMIENTAS Y MAQUINAS HERRAMIENTA	56,864.68		0.00	0.00	56,864.68	

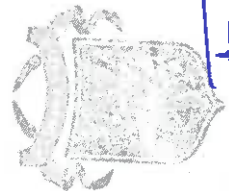
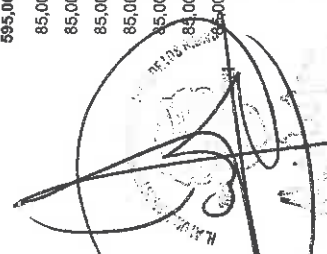

Ar Ayuntamiento Municipal Chilpancingo, Gro. CONTRALORIA INTERNA MUNICIPAL



H. AYUNTAMIENTO MUNICIPAL DE CHILPANCINGO, GRO.

SECRETARIA DE FINANZAS Y ADMINISTRACION

CONSOLIDADO



BALANZA DE COMPROBACIÓN DEL 1 DE ENERO AL 31 DE DICIEMBRE DEL 2019

C U E N T A	C O N C E P T O	SALDOS INICIALES		M O V I M I E N T O S		SALDOS ACUMULADOS	
		AL 1 DE ENERO DE 2019		ENERO - DICIEMBRE 2019		AL 31 DE DICIEMBRE DE 2019	
		DEBE	HABER	DEBE	HABER	DEBE	HABER
12467021022001001	EQUIPO DE RIEGO AGRICOLA 7HP 2X2 UKURA	4,000.00		0.00	0.00	4,000.00	
12467021022001002	CORTADORA PARA CONCRETO KOHLER 14HP	33,640.00		0.00	0.00	33,640.00	
12467021022001003	CON DISCO DE 14 PULGADAS BOMBA Y MOTOR 1HP, 25 GPM, 230V, N° DE SERIE: 16L1493782520.	19,224.68		0.00	0.00	19,224.68	
12467022	FONDO DE APORTE P/INFRA SOC MPAL	170,000.00		0.00	0.00	170,000.00	
12467022021	EJERCICIO 2016	120,000.00		0.00	0.00	120,000.00	
12467022021001	HERRAMIENTAS Y MAQUINAS HERRAMIENTA	120,000.00		0.00	0.00	120,000.00	
12467022022	EJERCICIO 2017	50,000.00		0.00	0.00	50,000.00	
12467022022001	HERRAMIENTAS, MAQUINARIA Y EQUIPO DE INGENIERIA	50,000.00		0.00	0.00	50,000.00	
12467022022001001	PLOTTER DE 24" HP	50,000.00		0.00	0.00	50,000.00	
12467023	FONDO DE APORTE P/FORT DE LOS MPIO	146,508.00		0.00	0.00	146,508.00	
12467023021	EJERCICIO 2016	33,080.00		37,260.00	0.00	183,768.00	
12467023021001	HERRAMIENTAS Y MAQUINAS HERRAMIENTA	33,080.00		0.00	0.00	33,080.00	
12467023022	EJERCICIO 2017	8,700.00		0.00	0.00	8,700.00	
12467023022001	HERRAMIENTAS Y MAQUINAS HERRAMIENTAS	8,700.00		0.00	0.00	8,700.00	
12467023022001001	KOMPRESSOR	8,700.00		0.00	0.00	8,700.00	
12467023024	EJERCICIO 2018	104,748.00		0.00	0.00	104,748.00	
12467023024001	HERRAMIENTAS Y MAQUINAS HERRAMIENTA	104,748.00		0.00	0.00	104,748.00	
12467023024001001	BOQUILLA DE MANGUERA CONTRA INCENDIO DE ENTRADA 1 1/2"	7,308.00		0.00	0.00	7,308.00	
12467023024001002	BOQUILLA DE MANGUERA CONTRA INCENDIO DE ENTRADA 1 1/2"	7,308.00		0.00	0.00	7,308.00	
12467023024001003	BOQUILLA DE MANGUERA CONTRA INCENDIO DE ENTRADA 1 1/2"	7,308.00		0.00	0.00	7,308.00	
12467023024001004	BOQUILLA DE MANGUERA CONTRA INCENDIO DE ENTRADA 1 1/2"	7,308.00		0.00	0.00	7,308.00	
12467023024001005	BOQUILLA DE MANGUERA CONTRA INCENDIO DE ENTRADA 1 1/2"	7,308.00		0.00	0.00	7,308.00	
12467023024001006	MANGUERA PROFESIONAL CONTRA INCENDIO 4 CAPAS DE 1 1/2" 15 M. COPLES DE ALUMINIO	4,547.20		0.00	0.00	4,547.20	
12467023024001007	MANGUERA PROFESIONAL CONTRA INCENDIO 4 CAPAS DE 1 1/2" 15 M. COPLES DE ALUMINIO	4,547.20		0.00	0.00	4,547.20	
12467023024001008	MANGUERA PROFESIONAL CONTRA INCENDIO 4 CAPAS DE 1 1/2" 15 M. COPLES DE ALUMINIO	4,547.20		0.00	0.00	4,547.20	
12467023024001009	MANGUERA PROFESIONAL CONTRA INCENDIO 4 CAPAS DE 1 1/2" 15 M. COPLES DE ALUMINIO	4,547.20		0.00	0.00	4,547.20	
12467023024001010	MANGUERA PROFESIONAL CONTRA INCENDIO 4 CAPAS DE 1 1/2" 15 M. COPLES DE ALUMINIO	4,547.20		0.00	0.00	4,547.20	
12467023024001011	MANGUERA PROFESIONAL CONTRA INCENDIO 4 CAPAS DE 1 1/2" 15 M. COPLES DE ALUMINIO	4,547.20		0.00	0.00	4,547.20	
12467023024001012	MANGUERA PROFESIONAL CONTRA INCENDIO 4 CAPAS DE 1 1/2" 15 M. COPLES DE ALUMINIO	4,547.20		0.00	0.00	4,547.20	
12467023024001013	MANGUERA PROFESIONAL CONTRA INCENDIO 4 CAPAS DE 1 1/2" 15 M. COPLES DE ALUMINIO	4,547.20		0.00	0.00	4,547.20	

Handwritten signature and stamp of the Secretary of Finance and Administration.







H. AYUNTAMIENTO MUNICIPAL DE CHILPANCINGO, GRO.

SECRETARIA DE FINANZAS Y ADMINISTRACION

CONSOLIDADO



BALANZA DE COMPROBACION DEL 1 DE ENERO AL 31 DE DICIEMBRE DEL 2019

C U E N T A	C O N C E P T O	SALDOS INICIALES		MOVIMIENTOS		SALDOS ACUMULADOS	
		AL 1 DE ENERO DE 2019		ENERO - DICIEMBRE 2019		AL 31 DE DICIEMBRE DE 2019	
		DEBE	HABER	DEBE	HABER	DEBE	HABER
12467023024001014	MANGUERA PROFESIONAL CONTRA INCENDIO 4	4,547.20		0.00	0.00	4,547.20	
12467023024001015	CAPAS DE 1 1/2" 15 M. COPLES DE ALUMINIO	4,547.20		0.00	0.00	4,547.20	
12467023024001016	MANGUERA PROFESIONAL CONTRA INCENDIO 4	4,547.20		0.00	0.00	4,547.20	
12467023024001017	MANGUERA PROFESIONAL CONTRA INCENDIO 4	4,547.20		0.00	0.00	4,547.20	
12467023024001018	CAPAS DE 1 1/2" 15 M. COPLES DE ALUMINIO	4,547.20		0.00	0.00	4,547.20	
12467023024001019	MANGUERA PROFESIONAL CONTRA INCENDIO 4	4,547.20		0.00	0.00	4,547.20	
12467023024001020	MANGUERA PROFESIONAL CONTRA INCENDIO 4	4,547.20		0.00	0.00	4,547.20	
12467023026	EJERCICIO 2019	0.00		37,260.00	0.00	37,260.00	
12467023026001	MAQUINARIA Y HERRAMIENTAS	0.00		37,260.00	0.00	37,260.00	
124670230260001	GENERADOR DE ENERGIA CHICO TRUPER	0.00		15,660.00	0.00	15,660.00	
12467023026001002	MOTOSIERRA STIHL 382 CON BARRA Y CADENA	0.00		10,800.00	0.00	10,800.00	
12467023026001003	MOTOSIERRA STIHL 382 CON BARRA Y CADENA	0.00		10,800.00	0.00	10,800.00	
12468	OTROS EQUIPOS	1,017,333.93		0.00	0.00	1,017,333.93	
12468001	GASTO CORRIENTE	1,017,333.93		0.00	0.00	1,017,333.93	
12468001004	ADMON 2009 - 2012	1,017,333.93		0.00	0.00	1,017,333.93	
12468001004001	OTROS EQUIPOS	1,017,333.93		0.00	0.00	1,017,333.93	
12469	OTROS EQUIPOS	907,556.82		46,980.00	0.00	954,536.82	
12469003	FONDO DE APORT P/FORT DE LOS MPIOS	907,556.82		0.00	0.00	907,556.82	
12469003004	ADMON 2009 - 2012	907,556.82		0.00	0.00	907,556.82	
12469003004001	OTROS (ESPECIFICAR)	907,556.82		0.00	0.00	907,556.82	
12469023	SEGURIDAD PUBLICA	0.00		26,680.00	0.00	26,680.00	
12469023026	EJERCICIO 2019	0.00		26,680.00	0.00	26,680.00	
12469023026001	OTROS EQUIPOS	0.00		26,680.00	0.00	26,680.00	
12469023026001001	SEMAFORO DE 3 LUCES DE 30 CM CON	0.00		13,340.00	0.00	13,340.00	
12469023026001002	UNIDADES A BASE DE LEDS (V-A-R)	0.00		13,340.00	0.00	13,340.00	
12469023026001002	SEMAFORO DE 3 LUCES DE 30 CM CON	0.00		13,340.00	0.00	13,340.00	
12469026	UNIDADES A BASE DE LEDS (V-A-R)	0.00		20,300.00	0.00	20,300.00	
12469026001	GASTO CORRIENTE	0.00		20,300.00	0.00	20,300.00	
12469026001026	OTROS EQUIPOS	0.00		20,300.00	0.00	20,300.00	
12469026001026001	EJERCICIO 2019	0.00		20,300.00	0.00	20,300.00	
12469026001026001001	MOTOSIERRA TELESCOPICA DE GASOLINA DE 8	0.00		20,300.00	0.00	20,300.00	
1247	PULGADAS MARCA STIHL	0.00		0.00	0.00	0.00	
12471	COLECCIONES, OBRAS DE ARTE Y OBJETOS VALIOSOS	0.00		0.00	0.00	0.00	
12471	BIENES ARTISTICOS, CULTURALES Y	285,406.06		0.00	0.00	285,406.06	
		285,406.06		0.00	0.00	285,406.06	

2018

*[Firma manuscrita]*

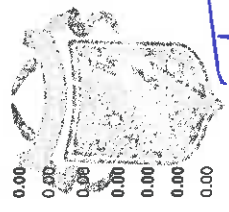

285,406.06

CONTRALORIA MUNICIPAL





H. AYUNTAMIENTO MUNICIPAL DE CHILPANCINGO, GRO.  
SECRETARIA DE FINANZAS Y ADMINISTRACION

CONSOLIDADO



BALANZA DE COMPROBACIÓN DEL 1 DE ENERO AL 31 DE DICIEMBRE DEL 2019

C U E N T A	C O N C E P T O	SALDOS INICIALES		MOVIMIENTOS		SALDOS ACUMULADOS	
		AL 1 DE ENERO DE 2019		ENERO - DICIEMBRE 2019		AL 31 DE DICIEMBRE DE 2019	
		DEBE	HABER	DEBE	HABER	DEBE	HABER
	CIENTÍFICOS						
12471001	GASTO CORRIENTE	135,766.06		0.00	0.00	135,766.06	
12471001005	ADMON 2012 - 2016	135,766.06		0.00	0.00	135,766.06	
12471001005001	BIENES ARTÍSTICOS, CULTURALES Y CIENTÍFICOS	135,766.06		0.00	0.00	135,766.06	
12471021	GASTO CORRIENTE	149,640.00		0.00	0.00	149,640.00	
12471021021	EJERCICIO 2016	149,640.00		0.00	0.00	149,640.00	
12471021021001	BIENES ARTÍSTICOS Y CULTURALES	149,640.00		0.00	0.00	149,640.00	
125	ACTIVOS INTANGIBLES	2,423,610.49		0.00	0.00	2,423,610.49	
1251	SOFTWARE	2,423,610.49		0.00	0.00	2,423,610.49	
12511	SOFTWARE	2,423,610.49		0.00	0.00	2,423,610.49	
12511022	OBRA PÚBLICA	2,423,610.49		0.00	0.00	2,423,610.49	
12511022021	EJERCICIO 2016	2,423,610.49		0.00	0.00	2,423,610.49	
12511022021001	SISTEMA CORAM MODULO AUTORIZACION PRESUPUESTAL, CHEQUES, CONCILIACIONES BANCARIAS E INGRESOS	1,861,643.28		0.00	0.00	1,861,643.28	
12511022021001001	SISTEMA DE LICENCIAS OPEN GPB MICROSOFT	1,583,400.00		0.00	0.00	1,583,400.00	
12511022021002	EJERCICIO 2017	278,243.28		0.00	0.00	278,243.28	
12511022021002001	LICENCIAS INFORMATICAS INTELECTUALES	394,499.30		0.00	0.00	394,499.30	
12511022021002001001	OFFICE 365 PORPLUS, 1 TB DE ALMACENAMIENTO VIA ONEDRIVE PRO. LICENCIA OPEN GOBIERNO	394,499.30		0.00	0.00	394,499.30	
12511022021002001001001	ESPAÑOL 64 BITS GOV OEM WINDOWS SERVER STD 2016 POR CORE (16 CORE)	239,999.50		0.00	0.00	239,999.50	
12511022021002001002	EJERCICIO 2018	116,999.80		0.00	0.00	116,999.80	
12511022021002001002001	LICENCIAS INFORMATICAS INTELECTUALES	37,500.00		0.00	0.00	37,500.00	
12511022021002001002001001	LICENCIAS DEL SISTEMA WINDOWS	167,467.91		0.00	0.00	167,467.91	
127	ACTIVOS DIFERIDOS	0.00		0.00	0.00	0.00	
1271	ESTUDIOS, FORMULACIÓN Y EVALUACIÓN DE PROYECTOS	0.00		2,192,056.55	2,192,056.55	2,192,056.55	0.00
12711	ESTUDIOS, FORMULACIÓN Y EVALUACIÓN DE PROYECTOS	0.00		2,192,056.55	2,192,056.55	2,192,056.55	0.00
12711022	FONDO DE APORTACION PARA LA INFRAESTRUCTURA SOCIAL MUNICIPAL	0.00		2,192,056.55	2,192,056.55	2,192,056.55	0.00
12711022002	OTROS PROYECTOS	0.00		2,192,056.55	2,192,056.55	2,192,056.55	0.00
12711022002026	EJERCICIO 2019	0.00		2,192,056.55	2,192,056.55	2,192,056.55	0.00
12711022002026001	CONTRATO	0.00		2,192,056.55	2,192,056.55	2,192,056.55	0.00
12711022002026001001	APERTURA DE BRECHA SACA COCECHAS, EN LA LOCALIDAD DE COACOTULILLO EN EL MUNICIPIO	0.00		1,108,535.61	1,108,535.61	1,108,535.61	0.00

2016  
2021  
2018

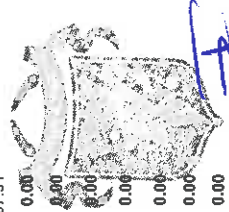

H. Ayuntamiento Municipal de Chilpancingo  
SECRETARIA DE FINANZAS Y ADMINISTRACION  
CONTADORIA INTERNA MUNICIPAL





H. AYUNTAMIENTO MUNICIPAL DE CHILPANCINGO, GRO.

SECRETARIA DE FINANZAS Y ADMINISTRACION

CONSOLIDADO

BALANZA DE COMPROBACIÓN DEL 1 DE ENERO AL 31 DE DICIEMBRE DEL 2019

C U E N T A	C O N C E P T O	SALDOS INICIALES		MOVIMIENTOS		SALDOS ACUMULADOS	
		AL 1 DE ENERO DE 2019		ENERO - DICIEMBRE 2019		AL 31 DE DICIEMBRE DE 2019	
		DEBE	HABER	DEBE	HABER	DEBE	HABER
21111021024021	JOSE VAZQUEZ COLEBRINA		7,885.74	0.00	0.00	0.00	7,885.74
21111021024022	JOSE EMMANUEL OROZCO SANCHEZ		19,845.97	0.00	0.00	0.00	19,845.97
21111021024023	EDGAR OSCIEL SALMERON GONZALEZ		5,373.84	0.00	0.00	0.00	5,373.84
21111021024024	DANTE ULISES RODRIGUEZ BELLO		13,916.93	0.00	0.00	0.00	13,916.93
21111021024025	JOSE DE JESUS TRIGO ALONSO		13,672.51	0.00	0.00	0.00	13,672.51
21111021024027	JAIME CAMP RAMIREZ		31,715.11	0.00	0.00	0.00	31,715.11
21111021024028	JOSE JUAN SALMERON GARCIA		12,110.51	0.00	0.00	0.00	12,110.51
21111021024029	ALBERTO FLORES TORRES		175.00	0.00	0.00	0.00	175.00
21111021024030	JESUS CASTREJON SANTANA		35.00	0.00	0.00	0.00	35.00
21111021024031	OSCAR DAVID ZEFERINO LOPEZ		70.00	0.00	0.00	0.00	70.00
21111021024032	MARTURO SALDAÑA NAVA		376.25	0.00	0.00	0.00	376.25
21111021024033	ESCAR OMAR CASTULO CATALAN		351.00	0.00	0.00	0.00	351.00
21111021024045	JOSE LUIS AGUILAR SANDOVAL		325.00	0.00	0.00	0.00	325.00
21111021024065	ALAN JOSAFAT RAMIREZ MANCILLA		325.00	0.00	0.00	0.00	325.00
21111021024069	FLORENCIO SANCHEZ JIMENEZ		50,609.90	0.00	0.00	0.00	50,609.90
21111021024074	JULIO CERROS FLORES		12.50	0.00	0.00	0.00	12.50
21111021024076	GENARO LUNA GALLARDO		35.00	0.00	0.00	0.00	35.00
21111021024076	MOISES CASTREJON SERRANO		153.75	0.00	0.00	0.00	153.75
21111021024077	GEOVANNY OLASCAGA NAVARRO		20.00	0.00	0.00	0.00	20.00
21111021024078	PRUDENCIO SALDAÑA GATICA		35.00	0.00	0.00	0.00	35.00
21111021024079	ADOLFO CRUZ JIMENEZ		13.33	0.00	0.00	0.00	13.33
21111021024084	MARIA NICODEMIUS REYES PONCE		1,365.74	0.00	0.00	0.00	1,365.74
21111021024082	SERGIO MANUEL FLORES ADAME		1,365.74	0.00	0.00	0.00	1,365.74
21111021024083	JOSE LUIS CERVANTES HERNANDEZ		1,365.74	0.00	0.00	0.00	1,365.74
21111021024084	FLORA SELENE VELAZQUEZ RAMIREZ		1,365.74	0.00	0.00	0.00	1,365.74
21111021024085	RAINER BELLO BEDOLLA		1,365.74	0.00	0.00	0.00	1,365.74
21111021024086	MIRIAM CASTRO HERNANDEZ		1,365.74	0.00	0.00	0.00	1,365.74
21111021024089	TERESA MOCTEZUMA MENDOZA		20.00	0.00	0.00	0.00	20.00
21111021024090	RUFINO REYES ZAMUDIO		157.50	0.00	0.00	0.00	157.50
21111021024084	ROBERTO ENRIQUE CORIA CORDOVA		12.50	0.00	0.00	0.00	12.50
21111021024100	SUELDO RETENIDOS POR PAGAR		2,104,809.24	0.00	0.00	0.00	2,104,809.24
21111021024165	JESUS ALBERTO OVANDO JIMENEZ		35.00	0.00	0.00	0.00	35.00

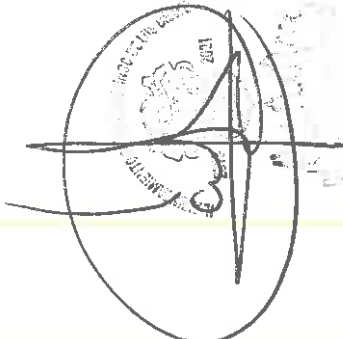

El Ayuntamiento Municipal Constitucional de Chilpancingo, Gro. a través de su Secretario de Finanzas y Administración



H. AYUNTAMIENTO MUNICIPAL DE CHILPANCINGO, GRO.

SECRETARIA DE FINANZAS Y ADMINISTRACION

CONSOLIDADO



BALANZA DE COMPROBACIÓN DEL 1 DE ENERO AL 31 DE DICIEMBRE DEL 2019

C U E N T A	C O N C E P T O	SALDOS INICIALES		MOVIMIENTOS		SALDOS ACUMULADOS	
		AL 1 DE ENERO DE 2019		ENERO - DICIEMBRE 2019		AL 31 DE DICIEMBRE DE 2019	
		DEBE	HABER	DEBE	HABER	DEBE	HABER
21111 021 024 166	NOLBERTO CASTRO CAMARGO		35.00	0.00	0.00	0.00	35.00
21111 021 024 167	JOSE MARTINEZ CORTEZ MALDONADO		45.00	0.00	0.00	0.00	45.00
21111 021 024 168	GREGORIA CALIXTO DIAZ		681.37	0.00	0.00	0.00	681.37
21111 021 024 169	CECILIA JUAREZ CORNELIO		681.37	0.00	0.00	0.00	681.37
21111 021 024 170	MARIA TERESA VELEZ LEYVA		681.37	0.00	0.00	0.00	681.37
21111 021 024 171	MARIA URBANA TECOMULAPA ABARCA		681.37	0.00	0.00	0.00	681.37
21111 021 024 172	PEDRO FELIX FLORES		681.37	0.00	0.00	0.00	681.37
21111 021 024 173	VICTOR MANUEL NOLAZCO GARCIA		681.37	0.00	0.00	0.00	681.37
21111 021 024 174	ALEJANDRO MARTINEZ RODRIGUEZ		1,618.19	0.00	0.00	0.00	1,618.19
21111 021 024 175	EJERCICIO 2018 (NVA. ADMINISTRACION)		387,505.43	8,937,223.07	9,049,579.45	9,049,579.45	499,881.81
21111 021 025 001	SUELDOS PENDIENTES POR PAGAR		361,659.20	0.00	118,326.44	0.00	479,985.64
21111 021 025 002	PENSION ALIMENTICIA		19,017.69	5,970.06	0.00	0.00	13,047.63
21111 021 025 003	ALICIA SOLIS MORENO		1,646.12	0.00	0.00	0.00	1,646.12
21111 021 025 004	ANTONIO GASPAS BELTRAN		0.00	35,074.70	35,074.70	0.00	0.00
21111 021 025 005	AGUINALDO PENDIENTE DE PAGO		5,182.42	5,383,692.29	5,383,692.29	0.00	5,182.42
21111 021 025 006	VARIOS		0.00	3,512,486.02	3,512,486.02	0.00	0.00
21111 021 026 001	EJERCICIO 2019 (NVA. ADMINISTRACION)		0.00	690,900,079.89	691,653,875.94	0.00	753,796.05
21111 021 026 002	LUIS VELEZ NAVA		0.00	2,000.00	2,000.00	0.00	0.00
21111 021 026 003	DIANA AIDA BELLO FLORES		0.00	5,000.00	5,000.00	0.00	0.00
21111 021 026 004	LAZARO ADALBERTO FIGUEROA RAMIREZ		0.00	20,000.00	20,000.00	0.00	0.00
21111 021 026 005	MARIA DE LOURDES ORTIZ BASURTO.		0.00	53,028.00	53,028.00	0.00	0.00
21111 021 026 006	ANTONIO GASPAS BELTRAN.		0.00	901,910.32	901,910.32	0.00	0.00
21111 021 026 007	ANA LILIA LEYVA SOTELO		0.00	924,793.89	924,793.89	0.00	0.00
21111 021 026 008	OSCAR ARMANDO GARIBAY VALDEZ		0.00	910,719.20	910,719.20	0.00	0.00
21111 021 026 009	ADOLFO CALDERON NAVA		0.00	924,793.89	924,793.89	0.00	0.00
21111 021 026 010	GURI CARMEN ZULLUAGA HUERTA		0.00	140,000.00	140,000.00	0.00	0.00
21111 021 026 011	FRANCISCO JAVIER VERGARA MARTINEZ		0.00	110,000.00	110,000.00	0.00	0.00
21111 021 026 012	VICTOR MANUEL ORTEGA CORONA		0.00	858,364.27	858,364.27	0.00	0.00
21111 021 026 013	SABINA RAMIREZ MONDOZA		0.00	924,793.89	924,793.89	0.00	0.00

CONTRALORIA INTERNA MUNICIPAL

H. Ayuntamiento Municipal Chilpancingo de Gro.  
CONTRALORIA INTERNA MUNICIPAL



H. AYUNTAMIENTO MUNICIPAL DE CHILPANCINGO, GRO.

SECRETARIA DE FINANZAS Y ADMINISTRACION

CONSOLIDADO



BALANZA DE COMPROBACION DEL 1 DE ENERO AL 31 DE DICIEMBRE DEL 2019

C U E N T A	C O N C E P T O	SALDOS INICIALES		M O V I M I E N T O S		SALDOS ACUMULADOS	
		AL 1 DE ENERO DE 2019		ENERO - DICIEMBRE 2019		AL 31 DE DICIEMBRE DE 2019	
		DEBE	HABER	DEBE	HABER	DEBE	HABER
21111021026013	JESUS RAUL SALGADO CARACHURE	0.00		910,719.20		910,719.20	0.00
21111021026014	BRENDA JANET RAMIREZ SANTOS	0.00		902,711.46		902,711.46	0.00
21111021026015	MANUEL VARGAS BARRIENTOS	0.00		849,795.02		849,795.02	0.00
21111021026016	BLANCA ALICIA CAMACHO DE LA CRUZ	0.00		935,712.59		935,712.59	0.00
21111021026017	ITANDUVI VILLALVA NAJERA	0.00		899,795.02		899,795.02	0.00
21111021026018	GUADALUPE ALMAZAN MORALES	0.00		878,795.01		878,795.01	0.00
21111021026019	SAMIR DANIEL AVILA BONILLA	0.00		910,719.20		910,719.20	0.00
21111021026020	LINO CASTILLO CANDIA	0.00		941,792.76		941,792.76	0.00
21111021026021	FERNANDO CALIXTO CUEVAS	0.00		130,000.00		130,000.00	0.00
21111021026022	ANTONIO OROZCO GUADARRAMA	0.00		105,000.00		105,000.00	0.00
21111021026023	ANA DILCIA TORRES ROMERO	0.00		180,000.00		180,000.00	0.00
21111021026024	WILIBALDO VALENTE PASTOR	0.00		270,000.00		270,000.00	0.00
21111021026025	LUIS CORTEZ GUEVARA	0.00		135,000.00		135,000.00	0.00
21111021026026	CELFA JUAREZ FIERRO	0.00		5,000.00		5,000.00	0.00
21111021026027	SUELDOS PENDIENTES POR PAGAR	0.00		258,146,088.93		258,734,552.33	588,463.40
21111021026028	PENSION ALIMENTICIA	0.00		4,433,863.28		4,454,017.07	20,153.79
21111021026029	NOE LUIS NAVA PEREZ	0.00		23,557.66		23,557.66	0.00
21111021026030	EFREN ENCARNACION NAVA	0.00		25,000.00		25,000.00	0.00
21111021026031	DIODELINA VEGA MENDOZA	0.00		5,512.06		5,512.06	0.00
21111021026032	EDGAR CAIN PEREZ BURCIAGA	0.00		60,500.00		60,500.00	0.00
21111021026033	MA. DEL ROCIO VEGA BAUTISTA	0.00		5,000.00		5,000.00	0.00
21111021026034	BENJAMIN VAZQUEZ SALAZAR	0.00		2,007.06		2,007.06	0.00
21111021026035	LILIANA REYNOSO SANCHEZ	0.00		2,611.10		2,611.10	0.00
21111021026036	AMAIRANI DIAZ ORTEGA	0.00		2,522.41		2,522.41	0.00
21111021026037	VIANEY CASTORENA TENORIO	0.00		844,419.38		844,419.38	0.00
21111021026038	BONOS PENDIENTES DE PAGO	0.00		10,381,729.56		10,481,504.56	99,775.00
21111021026039	ALICIA SOLIS MORENO	0.00		194,917.70		240,033.96	45,116.26
21111021026040	HUMBERTO ALARCON ALARCON	0.00		20,000.00		20,000.00	0.00
21111021026041	CECILIA NAVARRETE HERNANDEZ	0.00		64,631.44		64,631.44	0.00
21111021026042	EFREN ENCARNACION NAVA	0.00		2,000.00		2,000.00	0.00
21111021026043	EDGAR HERNANDO REYES MARTINEZ	0.00		38,294.30		38,294.30	0.00
21111021026044		0.00					0.00

Handwritten signature and stamp of the Secretary of Finance and Administration, dated 2021.

Official stamp of the Municipality of Chilpancingo, Gro., dated 2019.

Official stamp of the Municipality of Chilpancingo, Gro., dated 2021.

Official stamp of the Municipality of Chilpancingo, Gro., dated 2019.





H. AYUNTAMIENTO MUNICIPAL DE CHILPANCINGO, GRO.

SECRETARIA DE FINANZAS Y ADMINISTRACION

CONSOLIDADO



BALANZA DE COMPROBACION DEL 1 DE ENERO AL 31 DE DICIEMBRE DEL 2019

C U E N T A	C O N C E P T O	SALDOS INICIALES		M O V I M I E N T O S		SALDOS ACUMULADOS	
		AL 1 DE ENERO DE 2019		ENERO - DICIEMBRE 2019		AL 31 DE DICIEMBRE DE 2019	
		DEBE	HABER	DEBE	HABER	DEBE	HABER
21111021026045	ALEJANDRO HERNANDEZ ITURIO	0.00	0.00	11,604.34	11,604.34	11,604.34	0.00
21111021026046	FRANCISCO DE JESUS HERNANDEZ GOMEZ	0.00	0.00	45,000.00	45,000.00	45,000.00	0.00
21111021026047	CARLOS URIEL CARMONA PALACIOS	0.00	0.00	45,000.00	45,000.00	45,000.00	0.00
21111021026048	MIGUEL ANGEL GUERRERO GARCIA	0.00	0.00	5,000.00	5,000.00	5,000.00	0.00
21111021026052	AUDELINA RAMIREZ SANCHEZ	0.00	0.00	20,000.00	20,000.00	20,000.00	0.00
21111021026055	AGUINALDO PENDIENTE DE PAGO	0.00	0.00	40,667,616.48	40,667,616.48	40,667,616.48	287.60
21111021026056	ANDREA CAROLINA ADAME REQUEMEL	0.00	0.00	37,585.56	37,585.56	37,585.56	0.00
21111021026057	EDGAR GONZALEZ JERONIMO	0.00	0.00	5,000.00	5,000.00	5,000.00	0.00
21111021026058	REYNA AVILA ARMENTA	0.00	0.00	5,000.00	5,000.00	5,000.00	0.00
21111021026999	VARIOS	0.00	0.00	361,975,174.91	361,975,174.91	361,975,174.91	0.00
21111023	FONDO DE APORT P/FORT DE LOS NIPIOS	1,354,701.70	1,354,701.70	190,299,379.82	190,299,379.82	190,299,379.82	1,422,316.42
21111023024	EJERCICIO 2018	1,201,026.08	1,201,026.08	38,314.77	38,314.77	1,162,711.31	0.00
21111023024006	YOLANDA SALAS MARTINEZ	3,541.61	3,541.61	0.00	0.00	3,541.61	0.00
21111023024007	LUIS TREJO RODRIGUEZ	20,827.16	20,827.16	0.00	0.00	20,827.16	0.00
21111023024008	VICTOR MANUEL MORALES NICOLAS	3,928.75	3,928.75	0.00	0.00	3,928.75	0.00
21111023024009	SALOMON MIRANDA SALVADOR	14,459.93	14,459.93	0.00	0.00	14,459.93	0.00
21111023024010	LUIS DANIEL BAUTISTA GONZALEZ	18,183.22	18,183.22	0.00	0.00	18,183.22	0.00
21111023024011	JOSE JUAN VALENTE DORANTE	7,083.21	7,083.21	0.00	0.00	7,083.21	0.00
21111023024012	JESUS BELLO MENDIOLA	7,083.21	7,083.21	0.00	0.00	7,083.21	0.00
21111023024013	JORGE LUIS AGUILAR LEYVA	4,249.93	4,249.93	0.00	0.00	4,249.93	0.00
21111023024022	SUELDOS RETENIDOS PENDIENTE DE PAGO	1,119,669.06	1,119,669.06	38,314.77	38,314.77	1,081,354.29	0.00
21111023024026	JESSICA VIRIDIANA ALVARADO TORRES	500.00	500.00	0.00	0.00	500.00	0.00
21111023024026	LUIS MARTIN MARQUINA TERRERO	1,500.00	1,500.00	0.00	0.00	1,500.00	0.00
21111023025	EJERCICIO 2019 (NUEVA ADMINISTRACION)	153,676.62	153,676.62	59,169,784.58	59,169,784.58	59,170,339.99	154,231.03
21111023025001	SUELDOS PENDIENTES POR PAGAR	152,093.23	152,093.23	12,500.00	12,500.00	13,055.41	0.00
21111023025009	AGUINALDO PENDIENTE DE PAGO	1,582.39	1,582.39	4,351.63	4,351.63	4,351.63	0.00
21111023025889	VARIOS	0.00	0.00	59,152,932.95	59,152,932.95	59,152,932.95	0.00
21111023026	EJERCICIO 2019	0.00	0.00	131,091,280.47	131,091,280.47	131,196,654.55	105,374.08
21111023026001	SUELDOS PENDIENTES POR PAGAR	0.00	0.00	72,078,936.37	72,078,936.37	72,180,667.58	0.00
21111023026002	ALICIA SOLIS MORENO	0.00	0.00	5,971,228.11	5,971,228.11	5,971,228.11	0.00
21111023026003	SAMIR DANIEL AVILA BONILLA	0.00	0.00	31,073.56	31,073.56	31,073.56	0.00
21111023026004	LIZZETH ALMAZAN ROSAS	0.00	0.00	14,961.24	14,961.24	14,961.24	0.00

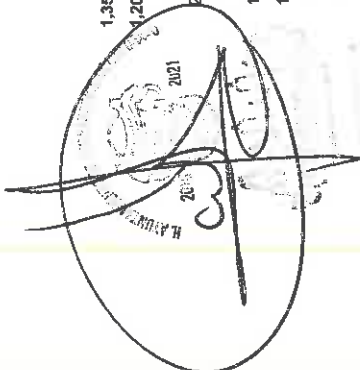
  
 H. AYUNTAMIENTO MUNICIPAL DE CHILPANCINGO, GRO.
   
 SECRETARIA DE FINANZAS Y ADMINISTRACION
   
 CONTRAL GENERAL MUNICIPAL





H. AYUNTAMIENTO MUNICIPAL DE CHILPANCINGO, GRO.  
SECRETARIA DE FINANZAS Y ADMINISTRACION  
CONSOLIDADO



BALANZA DE COMPROBACIÓN DEL 1 DE ENERO AL 31 DE DICIEMBRE DEL 2019

C U E N T A	C O N C E P T O	SALDOS INICIALES		MOVIMIENTOS		SALDOS ACUMULADOS	
		AL 1 DE ENERO DE 2019		ENERO - DICIEMBRE 2019		AL 31 DE DICIEMBRE DE 2019	
		DEBE	HABER	DEBE	HABER	DEBE	HABER
21111023026005	ROSALIO RAMIREZ CASTRO	0.00	0.00	12,000.00	12,000.00	12,000.00	0.00
21111023026006	EDGAR CAIN PEREZ BURCIAGA	0.00	0.00	10,000.00	10,000.00	10,000.00	0.00
21111023026007	ARTURO GONZALEZ CRISTOBAL	0.00	0.00	4,351.63	4,351.63	4,351.63	0.00
21111023026008	ESTEFFANYE DIANA LARA SONORA	0.00	0.00	2,197.96	2,197.96	2,197.96	0.00
21111023026009	JOVITA LOCIA LUISA	0.00	0.00	20,218.80	20,218.80	20,218.80	0.00
21111023026010	FABRICIO BAUTISTA ROMERO	0.00	0.00	55,000.00	55,000.00	55,000.00	0.00
21111023026011	BONOS PENDIENTES POR PAGAR	0.00	0.00	2,049,251.58	2,049,251.58	2,049,251.58	0.00
21111023026012	SABINO GARCIA MORALES	0.00	0.00	3,000.00	3,000.00	3,000.00	0.00
21111023026013	JULIAN PALACIOS NORBERTO	0.00	0.00	3,000.00	3,000.00	3,000.00	0.00
21111023026014	FORTUNATO MILLAN MORALES	0.00	0.00	3,000.00	3,000.00	3,000.00	0.00
21111023026015	JOSE MANUEL MILLAN MORALES	0.00	0.00	3,000.00	3,000.00	3,000.00	0.00
21111023026016	ANGEL JIMENEZ DE LA CRUZ	0.00	0.00	3,000.00	3,000.00	3,000.00	0.00
21111023026017	DIEGO SANCHEZ AVILA	0.00	0.00	3,000.00	3,000.00	3,000.00	0.00
21111023026018	LUCIO JIMENEZ DE LA CRUZ	0.00	0.00	3,000.00	3,000.00	3,000.00	0.00
21111023026019	ALEJANDRO GUZMAN SANCHEZ	0.00	0.00	3,000.00	3,000.00	3,000.00	0.00
21111023026020	MATIAS NAVA CATALAN	0.00	0.00	3,000.00	3,000.00	3,000.00	0.00
21111023026021	REYES GARCIA MARINO	0.00	0.00	3,000.00	3,000.00	3,000.00	0.00
21111023026022	LEONIDES MILLAN CABRERA	0.00	0.00	3,000.00	3,000.00	3,000.00	0.00
21111023026023	JUAN ANTONIO MILLAN MORALES	0.00	0.00	3,000.00	3,000.00	3,000.00	0.00
21111023026024	ROSALINO NORBERTO VENEGAS	0.00	0.00	3,000.00	3,000.00	3,000.00	0.00
21111023026025	OLIVERIO VENEGAS CALLETANO	0.00	0.00	3,000.00	3,000.00	3,000.00	0.00
21111023026026	AGUINALDO PENDIENTE DE PAGO	0.00	0.00	3,000.00	3,000.00	3,000.00	0.00
21111023026027	BALTAZAR DE LA CRUZ SOLACHE	0.00	0.00	8,842,026.78	8,842,026.78	8,845,669.65	3,642.87
21111023026028	HUGO ALFREDO HERNANDEZ ROMERO	0.00	0.00	43,227.83	43,227.83	43,227.83	0.00
21111023026029	VIARIOS	0.00	0.00	37,738.58	37,738.58	37,738.58	0.00
21111023026030	FORTASEG	0.00	0.00	41,877,068.03	41,877,068.03	41,877,068.03	0.00
21111023026031	EJERCICIO 2019	0.00	0.00	5,203,941.80	5,203,941.80	5,203,941.80	0.00
21114	BONO POR MEJORA CONDICIONES LABORALES (FORTASEG-COPARTICIPACION) SEGURIDAD SOCIAL Y SEGUROS POR PAGAR A COP	0.00	0.00	5,203,941.80	5,203,941.80	5,203,941.80	0.00
21114021	GASTO CORRIENTE	70,883,921.03	0.00	13,309,925.37	45,555,340.86	45,555,340.86	103,129,336.52
21114021020	PERIODO 2015-2018	61,406,867.39	0.00	9,189,237.68	37,037,463.18	37,037,463.18	89,315,092.89
2111402102001	FAV 1.8 % PATRONAL	1,608,095.77	0.00	0.00	0.00	0.00	1,608,095.77
		139,657.91	0.00	0.00	0.00	0.00	139,657.91

*[Handwritten signature and stamp]*



H. Ayuntamiento Municipal de Chilpancingo, Gro.  
SECRETARIA DE FINANZAS Y ADMINISTRACION  
CONTRALORIA MUNICIPAL



H. AYUNTAMIENTO MUNICIPAL DE CHILPANCINGO, GRO.

SECRETARIA DE FINANZAS Y ADMINISTRACION

CONSOLIDADO



BALANZA DE COMPROBACIÓN DEL 1 DE ENERO AL 31 DE DICIEMBRE DEL 2019

C U E N T A	C O N C E P T O	SALDOS INICIALES		MOVIMIENTOS		SALDOS ACUMULADOS	
		AL 1 DE ENERO DE 2019		ENERO - DICIEMBRE 2019		AL 31 DE DICIEMBRE DE 2019	
		DEBE	HABER	DEBE	HABER	DEBE	HABER
21114021020003	ISSPEG PATRONAL 12.0%		1,468,437.86		0.00	0.00	1,468,437.86
21114021021	PERIODO 2016		15,381,699.84		0.00	0.00	15,381,699.84
21114021021001	FAV 1.8 % PATRONAL		1,503,734.76		0.00	0.00	1,503,734.76
21114021021003	ISSPEG PATRONAL 12.0%		13,877,965.08		0.00	0.00	13,877,965.08
21114021022	EJERCICIO 2017		14,849,319.83		0.00	0.00	14,849,319.83
21114021022001	FAV 1.8 % PATRONAL		1,271,177.49		0.00	0.00	1,271,177.49
21114021022003	ISSPEG PATRONAL 15.0%		13,578,142.34		0.00	0.00	13,578,142.34
21114021023	EJERCICIO 2017 (OCT-DIC)		1,373,098.40		0.00	0.00	1,373,098.40
21114021023001	FAV 1.8 % PATRONAL		407,334.34		0.00	0.00	407,334.34
21114021023003	ISSPEG PATRONAL 15.0%		965,764.06		0.00	0.00	965,764.06
21114021024	EJERCICIO 2018		19,930,374.60		2,898,217.54	0.00	17,032,157.06
21114021024001	FAV 1.8 % PATRONAL		545,073.42		0.00	0.00	545,073.42
21114021024002	ISSSTE PATRONAL 8.5%		2,898,217.54		2,898,217.54	0.00	5,796,290.96
21114021024003	ISSPEG PATRONAL 15.0%		15,487,083.64		0.00	0.00	15,487,083.64
21114021025	EJERCICIO 2018 (NUEVA ADMINISTRACION)		8,264,278.95		5,148,387.07	0.00	13,412,666.02
21114021025001	FAV 1.8 % PATRONAL		525,487.30		262,400.93	0.00	787,888.23
21114021025002	ISSSTE PATRONAL 8.5%		2,242,868.80		2,173,059.17	0.00	4,415,927.97
21114021025003	ISSPEG PATRONAL 15.0%		5,495,922.85		2,712,926.97	0.00	8,208,849.82
21114021026	EJERCICIO 2019		0.00		1,142,633.07	37,097,463.18	37,097,463.18
21114021026001	FAV 1.8 % PATRONAL		0.00		0.00	2,139,254.55	2,139,254.55
21114021026002	ISSSTE PATRONAL 8.5%		0.00		1,142,633.07	9,742,532.81	10,885,165.88
21114021026003	ISSPEG PATRONAL 15.0%		0.00		0.00	25,215,675.82	25,215,675.82
21114023	FONDO DE APORT P/FORT DE LOS MPIO		9,477,053.64		4,120,687.69	8,457,877.68	22,055,619.01
21114023020	ADMON 2015-2018		234,045.25		0.00	0.00	234,045.25
21114023020001	1.8% FAV PATRONAL		10,064.28		0.00	0.00	10,064.28
21114023020002	6% CUOTAS PATRON ISSPEG		223,980.99		0.00	0.00	223,980.99
21114023021	EJERCICIO 2016		2,472,247.74		0.00	0.00	2,472,247.74
21114023021001	1.8% FAV PATRONAL		72,143.36		0.00	0.00	72,143.36
21114023021002	6% CUOTAS PATRON ISSPEG		2,400,104.38		0.00	0.00	2,400,104.38
21114023022	EJERCICIO 2017		2,726,836.22		205,551.95	205,551.95	2,932,388.17
21114023022001	1.8% FAV PATRONAL		89,282.93		0.00	0.00	89,282.93
21114023022002	6% CUOTAS PATRON ISSPEG		2,637,553.29		205,551.95	205,551.95	2,843,105.24
21114023024	EJERCICIO 2018		2,123,374.65		981,520.71	0.00	3,104,895.36

2019  
 SECRETARIA DE FINANZAS Y ADMINISTRACION  
 CHILPANCINGO, GRO.  
 2019

AYUNTAMIENTO MUNICIPAL CONSOLIDADO  
 CHILPANCINGO, GRO.  
 2019

AYUNTAMIENTO MUNICIPAL CONSOLIDADO  
 CHILPANCINGO, GRO.  
 2019

AYUNTAMIENTO MUNICIPAL CONSOLIDADO  
 CHILPANCINGO, GRO.  
 2019

AYUNTAMIENTO MUNICIPAL CONSOLIDADO  
 CHILPANCINGO, GRO.  
 CONTRALORIA GENERAL MUNICIPAL



H. AYUNTAMIENTO MUNICIPAL DE CHILPANCINGO, GRO.

SECRETARIA DE FINANZAS Y ADMINISTRACION

CONSOLIDADO



BALANZA DE COMPROBACIÓN DEL 1 DE ENERO AL 31 DE DICIEMBRE DEL 2019

C U E N T A	C O N C E P T O	SALDOS INICIALES		M O V I M I E N T O S		SALDOS ACUMULADOS	
		AL 1 DE ENERO DE 2019		ENERO - DICIEMBRE 2019		AL 31 DE DICIEMBRE DE 2019	
		DEBE	HABER	DEBE	HABER	DEBE	HABER
21114023024001	1.8% FAV PATRONAL		42,123.04		0.00		42,123.04
21114023024002	6% CUOTAS PATRON ISSSPEG		1,099,730.90		0.00		1,099,730.90
21114023024003	ISSSTE CUOTAS PATRON		981,520.71		981,520.71		0.00
21114023025	EJERCICIO 2018 IVA ADMINISTRACION		1,920,549.78		1,897,865.83		22,663.95
21114023025001	1.8% FAV PATRONAL		42,571.72		19,907.77		22,663.95
21114023025002	6% CUOTAS PATRON ISSSPEG		1,140,228.44		1,140,228.44		0.00
21114023025003	ISSSTE CUOTAS PATRON		737,749.62		737,749.62		0.00
21114023026	EJERCICIO 2019		0.00		1,035,729.20		8,252,325.73
21114023026001	1.8% FAV PATRONAL		0.00		0.00		172,007.31
21114023026002	6% CUOTAS PATRON ISSSPEG		0.00		655,034.49		4,450,614.26
21114023026003	ISSSTE CUOTAS PATRON		0.00		380,694.71		2,974,669.67
2112	PROVEEDORES POR PAGAR A CORTO PLAZO		0.00		0.00		165,359,970.60
21121	DEUDAS POR ADQUISICION DE BIENES Y CONTRATACION DE SERVICIOS POR PAGAR A CP		9,415,459.02		153,322,609.91		21,452,819.71
21121021	GASTO CORRIENTE		9,415,459.02		153,322,609.91		21,452,819.71
21121021020	EJERCICIO 2015-2018		6,211,025.27		66,203,905.47		10,951,792.73
2112102102004	FRANCISCO JAVIER OSORIO FLORES		3,016.00		0.00		528,413.61
2112102102006	OLIVIA CARBAJAL URIBE		2,200.00		0.00		3,016.00
2112102102009	"ALEX" DE S DE RL MI.		9,964.40		0.00		23,200.00
2112102102024	MANUEL CASTILLO JAIMES		15,000.00		0.00		9,964.40
2112102102029	ROSENDO RENDON LUCAS		26,013.00		0.00		15,000.00
2112102102037	COMERCIALIZADORA TERRAZAS		84,220.64		0.00		26,013.00
2112102102048	EQUIPO DE COPIADO E IMPRESION DE GUERRERO SA DE CV		20,184.00		0.00		84,220.64
2112102102051	SOCORRO OLIVIA HERNANDEZ		7,540.00		0.00		20,184.00
2112102102068	MAGOOT S.A. DE C.V.		19,070.01		0.00		7,540.00
2112102102080	RADIO IDEAS DEL PACIFICO SA DE CV		34,800.00		0.00		19,070.01
2112102102061	MARBELL S.A. DE C.V.		3,410.40		0.00		34,800.00
2112102102064	RUPERTO SILVERIO RAMIREZ		100,004.98		0.00		3,410.40
2112102102065	IMPULSORA GUIMARSA DEL PACIFICO SA DE CV		121,166.40		0.00		100,004.98
2112102102069	AMANDO ESQUIVEL VAZQUEZ		60,823.78		0.00		121,166.40
21121021021	EJERCICIO 2016		1,539,395.94		0.00		60,823.78
							1,539,395.94

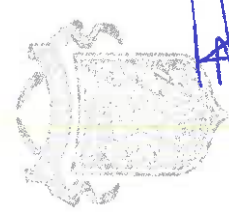
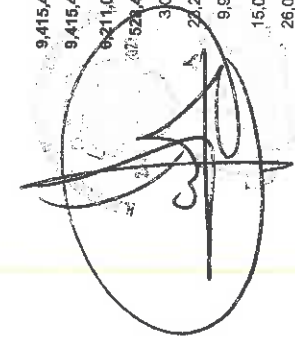

H. Ayuntamiento Municipal Chilpancingo, Gro. Contraloría Interna Municipal



H. AYUNTAMIENTO MUNICIPAL DE CHILPANCINGO, GRO.

SECRETARIA DE FINANZAS Y ADMINISTRACION

CONSOLIDADO



BALANZA DE COMPROBACION DEL 1 DE ENERO AL 31 DE DICIEMBRE DEL 2019

C U E N T A	C O N C E P T O	SALDOS INICIALES		M O V I M I E N T O S		SALDOS ACUMULADOS	
		AL 1 DE ENERO DE 2019		ENERO - DICIEMBRE 2019		AL 31 DE DICIEMBRE DE 2019	
		DEBE	HABER	DEBE	HABER	DEBE	HABER
21121021021007	GUSTAVO SALAZAR ADAME		15,000.00	0.00	0.00	0.00	15,000.00
21121021021028	COMERCIALIZADORA POLIMAS DEL SUR SA DE CV		34,800.00	0.00	0.00	0.00	34,800.00
21121021021031	ANZALDUA CATALAN HERNANDO MAURICIO		49,532.00	0.00	0.00	0.00	49,532.00
21121021021034	MARIO LOYA JUAREZ		17,229.56	0.00	0.00	0.00	17,229.56
21121021021041	BEATRIZ ADRIANA FABIAN ZAMORA		32,727.40	0.00	0.00	0.00	32,727.40
21121021021046	GRUPO RADIOFUSORA CAPITAL SA DE CV		80,000.00	0.00	0.00	0.00	80,000.00
21121021021056	GRUPO GASTRONOMICO TECUAN S.A. DE C.V.		23,484.00	0.00	0.00	0.00	23,484.00
21121021021059	JOSE ROBERTO CARBAJAL BELLO		140,311.44	0.00	0.00	0.00	140,311.44
21121021021060	RADIO IDEAS DEL PACIFICO SA DE CV		34,800.00	0.00	0.00	0.00	34,800.00
21121021021062	CLEMENTE BELLO GARCIA		98,133.70	0.00	0.00	0.00	98,133.70
21121021021065	IMPULSORA GUIMARSA DEL PACIFICO SA DE CV		175,704.01	0.00	0.00	0.00	175,704.01
21121021021072	AXEL FERNANDO TAVARES GARCIA		9,280.00	0.00	0.00	0.00	9,280.00
21121021021073	GRUPO CONSTRUCTOR YIVALE SA DE CV		21,541.78	0.00	0.00	0.00	21,541.78
21121021021074	ALEXIS BENJAMIN JIMENEZ CEDILLO		580.00	0.00	0.00	0.00	580.00
21121021021081	ROGELIO CASTRO ALDAY		74,240.00	0.00	0.00	0.00	74,240.00
21121021021082	OLIVIA NAVA MOSSO		11,600.00	0.00	0.00	0.00	11,600.00
21121021021086	JAIMÉ MARTÍN CHAVEZ MARQUEZ		31,410.48	0.00	0.00	0.00	31,410.48
21121021021087	MARTHA SILVIA QUIROZ TREJO		34,800.00	0.00	0.00	0.00	34,800.00
21121021021093	MARIBEL JULIAN CATALAN		105,491.20	0.00	0.00	0.00	105,491.20
21121021021102	CESAR ALBERTO AVILA MOCTEZUMA		62,540.00	0.00	0.00	0.00	62,540.00
21121021021109	MANUEL HERNANDEZ TRUJILLO		43,669.20	0.00	0.00	0.00	43,669.20
21121021021113	AZAZEL MIZERRAIM GONZALEZ RIOS		33,750.00	0.00	0.00	0.00	33,750.00
21121021021119	TERESA HERNANDEZ DE DIOS		3,930.00	0.00	0.00	0.00	3,930.00
21121021021121	JAIMÉ CISNEROS MEMIJE		4,500.00	0.00	0.00	0.00	4,500.00
21121021021122	OLIVER ROJAS HERNANDEZ		13,554.84	0.00	0.00	0.00	13,554.84
21121021021124	JOSE ANGEL ZAMORA LORENZO		3,796.70	0.00	0.00	0.00	3,796.70
21121021021125	SH COMERCIALIZADORA, S.A. DE C.V.		9,746.54	0.00	0.00	0.00	9,746.54
21121021021140	MARIANA GARDUÑO ARCOS		46,400.00	0.00	0.00	0.00	46,400.00
21121021021142	BLANCA ANDREA MORALES MENDEZ		6,000.00	0.00	0.00	0.00	6,000.00
21121021021144	COMERCIALIZADORA LUSAHE, S.A. DE CV		9,755.37	0.00	0.00	0.00	9,755.37
Coram/ Balanza							

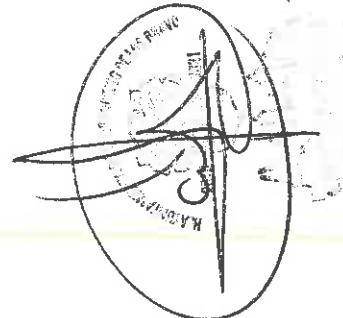

M. Ayuntamiento Municipal Consolidado Chilpancingo Contraloría Interiores Municipal

miércoles 25 marzo 2020

6.08.08 PM





H. AYUNTAMIENTO MUNICIPAL DE CHILPANCINGO, GRO.  
SECRETARIA DE FINANZAS Y ADMINISTRACION  
CONSOLIDADO



BALANZA DE COMPROBACION DEL 1 DE ENERO AL 31 DE DICIEMBRE DEL 2019

C U E N T A	C O N C E P T O	SALDOS INICIALES		M O V I M I E N T O S		SALDOS ACUMULADOS	
		AL 1 DE ENERO DE 2019		ENERO - DICIEMBRE 2019		AL 31 DE DICIEMBRE DE 2019	
		DEBE	HABER	DEBE	HABER	DEBE	HABER
21121021021148	SOCORRO OLIVIA HERNANDEZ		12,500.01		0.00	0.00	12,500.01
21121021021155	VICTOR MANUEL ROMAN MARTINEZ		84,700.00		0.00	0.00	84,700.00
21121021021170	AGUSTIN NAVA ESCOBAR		3,480.00		0.00	0.00	3,480.00
21121021021172	MIGUEL ANGEL JUAREZ MENES		4,240.00		0.00	0.00	4,240.00
21121021021185	ROMAN CHINEY FAJARDO		3,306.00		0.00	0.00	3,306.00
21121021021196	FORMAS PARA NEGOCIOS S.A. DE C.V.		29,919.30		0.00	0.00	29,919.30
21121021021205	CONCEPCION CRUZ GARCIA		3,480.00		0.00	0.00	3,480.00
21121021021208	TELECOMUNICACIONES DEL GOLFO S.A. DE C.V.		65,384.55		0.00	0.00	65,384.55
21121021021210	GRUPO A&T. CELULAR S.R.L. DE C.V.		65,384.55		0.00	0.00	65,384.55
21121021021217	MARINO CABRERA MORENO		24,673.31		0.00	0.00	24,673.31
21121021021223	MA. ELVIA DIMAYUGA GARCIA		10,440.00		0.00	0.00	10,440.00
21121021021226	BETSAIDA MENDEZ ABARCA		3,480.00		0.00	0.00	3,480.00
21121021022	EJERCICIO 2017		2,825.76		0.00	0.00	2,825.76
21121021022049	MARILU ROJANO CIENFUEGOS		2,825.76		0.00	0.00	2,825.76
21121021024	EJERCICIO 2018		2,059,186.25		7,000.00	0.00	2,052,186.25
21121021024005	GUSTAVO SALAZAR ADAME		40,000.00		0.00	0.00	40,000.00
21121021024006	OLIVIA NAVA MOSSO		30,160.00		0.00	0.00	30,160.00
21121021024014	TOMAS JIMENEZ PERALTA		74,057.33		0.00	0.00	74,057.33
21121021024029	ROSENDO RENDON LUCAS		19,488.00		0.00	0.00	19,488.00
21121021024034	OLIVIA CARBAJAL URIBE		11,600.00		0.00	0.00	11,600.00
21121021024052	ILSE IVETTE JUAREZ RODRIGUEZ		295.80		0.00	0.00	295.80
21121021024057	LEOPOLDINA EUGENIA DUENAS RIVERA		7,000.00		7,000.00	0.00	0.00
21121021024062	GUADALUPE SALAS MORALES		8,000.00		0.00	0.00	8,000.00
21121021024070	LIXO PROYECTOS AMBIENTALES, S.A. DE C.V.		146,689.14		0.00	0.00	146,689.14
21121021024073	CONSTRUCTORA E INMOBILIARIA SYMAT, S.A. DE C.V.		385,660.00		0.00	0.00	385,660.00
21121021024083	CARLOS OLIVARES RODRIGUEZ		23,200.00		0.00	0.00	23,200.00
21121021024088	PABLO ANTONIO ASTUDILLO PERALTA		130,000.00		0.00	0.00	130,000.00
21121021024098	SOCORRO EDITH DELOYA MARTINEZ		489,656.30		0.00	0.00	489,656.30
21121021024100	CONSTRUCTORA Y ARRENDADORA DEALLIR GROUP S.A. DE C.V.		485,100.00		0.00	0.00	485,100.00

*(Handwritten signature and date: 2019)*



H. Ayuntamiento Municipal de Chilpancingo, Gro.  
CONTRALORIA INTERNA MUNICIPAL



H. AYUNTAMIENTO MUNICIPAL DE CHILPANCINGO, GRO.

SECRETARIA DE FINANZAS Y ADMINISTRACION

CONSOLIDADO



BALANZA DE COMPROBACION DEL 1 DE ENERO AL 31 DE DICIEMBRE DEL 2019

C U E N T A	C O N C E P T O	SALDOS INICIALES		M O V I M I E N T O S		SALDOS ACUMULADOS	
		AL 1 DE ENERO DE 2019		ENERO - DICIEMBRE 2019		AL 31 DE DICIEMBRE DE 2019	
		DEBE	HABER	DEBE	HABER	DEBE	HABER
21121021024103	AURELIO RIGOBERTO CASTRO HERNANDEZ		24,000.00		0.00		24,000.00
21121021024104	ROSALINDA VALLE NAVA		278.40		0.00		278.40
21121021024116	BALSAS MEDIOS DE COMUNICACION, S.A. DE C.V.		11,600.00		0.00		11,600.00
21121021024120	ADRIANA MIREL NAMBO MORALES		20,508.80		0.00		20,508.80
21121021024197	HECTOR GARCIA ALVAREZ		40,600.00		0.00		40,600.00
21121021024236	XA CONSTRUCCIONES SA DE CV		111,292.48		0.00		111,292.48
21121021025	EJERCICIO 2018 (NVA. ADMINISTRACION)		2,081,203.71		2,681,971.68		638,225.15
21121021025005	COMISION FEDERAL DE ELECTRICIDAD		124,073.00		112,652.00		11,421.00
21121021025008	MARGALIT BAILON MIRANDA		5,418.67		5,418.67		0.00
21121021025007	KAREN YULIENY NAVA MONDRAGON		491,786.34		475,727.71		16,058.63
21121021025008	EDSON MIGUEL SALDIVAR TREJO		13,027.12		13,027.12		0.00
21121021025009	ANTONIO CATALAN GARCIA		17,000.01		17,000.01		0.00
21121021025010	PATRICIA MELGOZA SALLMERON		66,665.97		66,665.97		0.00
21121021025011	MIRIAM DAMIAN GONZALEZ		18,634.77		18,634.15		0.00
21121021025012	VERENICE ALMAZAN APARICIO		76,428.46		76,428.46		0.62
21121021025013	EDUARDO ALMAZAN APARICIO		334,447.08		333,447.08		0.00
21121021025014	CRISTINA CENTENO RAMIREZ		429,857.26		429,857.26		1,000.00
21121021025015	ELIZA OTERO FLORES		63,326.59		63,326.59		0.00
21121021025016	LUIS OCTAVIO EDMUNDO UNZUETA CASTAÑON		23,611.71		23,611.71		0.00
21121021025017	REY URGEOL GARCIA VICARIO		32,039.77		32,039.77		0.00
21121021025018	JESUS ANTONIO ROBLES VALDEZ		3,671.40		3,671.40		0.00
21121021025019	JESUS ANTONIO ROBLES VALDEZ		0.00		2,535.00		2,535.00
21121021025021	TERESA HERNADEZ DE DIOS		120,000.00		120,000.00		0.00
21121021025022	ARTURO VALENTE SALDAÑA		20,000.00		20,000.00		0.00
21121021025023	AUDELINA RAMIREZ SANCHEZ		38,977.49		38,977.49		0.00
21121021025024	ALAN BEJAR NAJERA		5,160.14		5,160.14		0.00
21121021025025	COMERCIALIZADORA GENERAL DE LA MONTANA SA DE CV		173,101.00		173,101.00		0.00
21121021025066	JAVIER FRANCISCO REYES		15,000.00		15,000.00		0.00
21121021025061	JOSE ANTONIO FIERRO PEREZ		8,976.93		0.00		8,976.93
21121021025099	VARIOS		0.00		635,690.15		635,690.15
21121021026	EJERCICIO 2019		0.00		63,514,933.79		63,514,933.79
21121021026002	COMISION FEDERAL DE ELECTRICIDAD		0.00		1,011,638.53		1,011,638.53

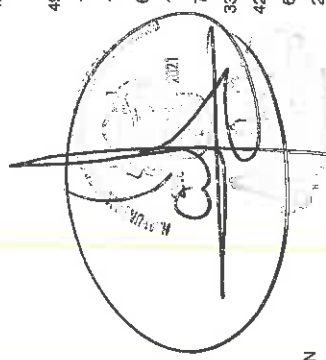

H. Ayuntamiento Municipal Constitucional de Chilpancingo, Gro. 6.08.08 PM

H. AYUNTAMIENTO MUNICIPAL DE CHILPANCINGO, GRO.

SECRETARIA DE FINANZAS Y ADMINISTRACION

CONSOLIDADO



BALANZA DE COMPROBACION DEL 1 DE ENERO AL 31 DE DICIEMBRE DEL 2019

C U E N T A	C O N C E P T O	SALDOS INICIALES		M O V I M I E N T O S				SALDOS ACUMULADOS	
		AL 1 DE ENERO DE 2019		ENERO - DICIEMBRE 2019		AL 31 DE DICIEMBRE DE 2019			
		DEBE	HABER	DEBE	HABER	DEBE	HABER	DEBE	HABER
21121021026003	SERVICIO DE ADMINISTRACION TRIBUTARIA	0.00	0.00	2,085.00	2,085.00	2,085.00	2,085.00	0.00	0.00
21121021026004	COMERCIALIZADORA GENERAL DE LA MONTANA S.A. DE C.V.	0.00	0.00	262,403.60	782,586.12	262,403.60	782,586.12	520,182.52	0.00
21121021026005	MIGUEL ANGEL ALARCON LEON.	0.00	0.00	4,122.64	4,122.64	4,122.64	4,122.64	0.00	0.00
21121021026006	JOSE LUIS ANZURES DURAN	0.00	0.00	145,103.94	145,103.94	145,103.94	145,103.94	0.00	0.00
21121021026007	YURIRIA TANET BAHENA ALVAREZ	0.00	0.00	40,600.00	40,600.00	40,600.00	40,600.00	0.00	0.00
21121021026008	JUAN FRANCISCO SIGUENZA SERRANO	0.00	0.00	3,303,227.61	3,303,227.61	3,303,227.61	3,303,227.61	0.00	0.00
21121021026008	EDGARDO ASTUDILLO MORALES	0.00	0.00	13,133,258.14	13,583,414.22	13,133,258.14	13,583,414.22	450,156.08	0.00
21121021026010	LUCIA GONZALEZ DE LA CRUZ	0.00	0.00	417,100.00	417,100.00	417,100.00	417,100.00	0.00	0.00
21121021026011	ENRIQUE CASTREJON ADAME	0.00	0.00	176,900.00	176,900.00	176,900.00	176,900.00	0.00	0.00
21121021026012	GUADALUPE SALAS MORALES	0.00	0.00	80,000.00	80,000.00	80,000.00	80,000.00	0.00	0.00
21121021026013	CABLEMAS TELECOMUNICACIONES S.A. DE C.V.	0.00	0.00	44,854.99	44,854.99	44,854.99	44,854.99	3,615.00	0.00
21121021026014	IVAN RODRIGUEZ NAVARRETE	0.00	0.00	84,582.75	84,582.75	84,582.75	84,582.75	0.00	0.00
21121021026015	YESENIA FIGUEROA CARRANZA	0.00	0.00	436,254.86	436,254.86	436,254.86	436,254.86	0.00	0.00
21121021026016	FABIAN RIVERA ZUÑIGA	0.00	0.00	27,148.70	27,148.70	27,148.70	27,148.70	0.00	0.00
21121021026017	TERESA HERNANDEZ DE DIOS	0.00	0.00	1,356,442.20	1,356,442.20	1,356,442.20	1,356,442.20	240,000.00	0.00
21121021026018	EDITORIAL EVE, S.A. DE C.V.	0.00	0.00	315,000.00	315,000.00	315,000.00	315,000.00	0.00	0.00
21121021026019	EDITORIAL EVE, S.A. DE C.V.	0.00	0.00	150,000.09	150,000.09	150,000.09	150,000.09	0.00	0.00
21121021026020	CARLOS OLIVARES RODRIGUEZ	0.00	0.00	232,000.00	232,000.00	232,000.00	232,000.00	0.00	0.00
21121021026021	MULTIMEDICS DE GUERRERO, S.A. DE C.V.	0.00	0.00	638,000.00	638,000.00	638,000.00	638,000.00	58,000.00	0.00
21121021026022	CONDUCTOR GARCIA ALVAREZ	0.00	0.00	300,000.00	300,000.00	300,000.00	300,000.00	60,000.00	0.00
21121021026023	GUSTAVO SALAZAR ADAME	0.00	0.00	150,000.00	150,000.00	150,000.00	150,000.00	0.00	0.00
21121021026024	VERTICE DIARIO DE CHILPANCINGO S.A. DE C.V.	0.00	0.00	556,800.00	556,800.00	556,800.00	556,800.00	0.00	0.00
21121021026025	DIGITAL CON SENTIDO SOCIAL 106.3	0.00	0.00	120,000.08	120,000.08	120,000.08	120,000.08	0.00	0.00
21121021026026	MEXICO RADIO, S.A. DE C.V.	0.00	0.00	45,000.03	45,000.03	45,000.03	45,000.03	0.00	0.00
21121021026027	JAVIER FRANCISCO REYES	0.00	0.00	150,000.00	150,000.00	150,000.00	150,000.00	0.00	0.00
21121021026028	CABLEMAS TELECOMUNICACIONES S.A. DE C.V.	0.00	0.00	1,685.00	1,685.00	1,685.00	1,685.00	0.00	0.00
21121021026029	COMISION NACIONAL DEL AGUA	0.00	0.00	2,085.00	2,085.00	2,085.00	2,085.00	0.00	0.00
21121021026030	MARIA PALACIOS SALAZAR	0.00	0.00	5,800.00	5,800.00	5,800.00	5,800.00	0.00	0.00
21121021026031	OLIVIA NAVA MOSSO	0.00	0.00	15,000.00	15,000.00	15,000.00	15,000.00	0.00	0.00
21121021026032	ENRIQUE ARREOLA OCHOA	0.00	0.00	5,000.01	5,000.01	5,000.01	5,000.01	0.00	0.00

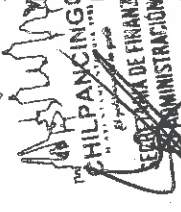
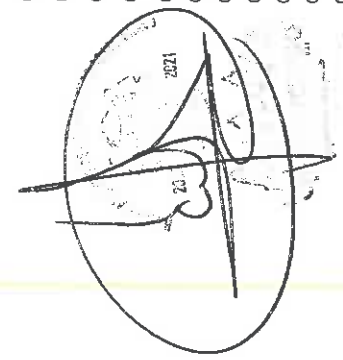



H. AYUNTAMIENTO MUNICIPAL DE CHILPANCINGO, GRO.

SECRETARIA DE FINANZAS Y ADMINISTRACION

CONSOLIDADO



BALANZA DE COMPROBACION DEL 1 DE ENERO AL 31 DE DICIEMBRE DEL 2019

C U E N T A	C O N C E P T O	SALDOS INICIALES		M O V I M I E N T O S		SALDOS ACUMULADOS	
		AL 1 DE ENERO DE 2019		ENERO - DICIEMBRE 2019		AL 31 DE DICIEMBRE DE 2019	
		DEBE	HABER	DEBE	HABER	DEBE	HABER
21121021026033	JORGE LOZANO BELLO	0.00	0.00	10,000.00	10,000.00	10,000.00	0.00
21121021026034	AURELIO RIGOBERTO CASTRO HERNANDEZ	0.00	0.00	88,416.00	114,168.00	114,168.00	25,752.00
21121021026035	CANAL XXI S.A. DE C.V.	0.00	0.00	261,000.00	290,000.00	290,000.00	29,000.00
21121021026036	JAIME ISRAEL IRRA ZAMORA	0.00	0.00	15,000.00	15,000.00	15,000.00	0.00
21121021026037	NESTOR ORTEGA ALMEIDA MORALES	0.00	0.00	58,000.00	58,000.00	58,000.00	0.00
21121021026038	MEXICO RADIO, S.A. DE C.V.	0.00	0.00	105,000.07	135,000.09	135,000.09	30,000.02
21121021026039	CAPITAL RADIO, S.A. DE C.V.	0.00	0.00	300,000.00	360,000.00	360,000.00	60,000.00
21121021026040	VICTOR GUERRERO SALGADO	0.00	0.00	41,605.00	41,605.00	41,605.00	0.00
21121021026041	OSCAR ROBERTO GARCE TAPIA	0.00	0.00	7,598.00	7,598.00	7,598.00	0.00
21121021026042	CHINQUEQUE FILMS A.C.	0.00	0.00	63,800.00	63,800.00	63,800.00	0.00
21121021026043	MARIA MAGDALENA ALVAREZ ZAMORA	0.00	0.00	132,680.01	132,680.01	132,680.01	0.00
21121021026044	ANAIM ASOCIACION NACIONAL DE ALIANZAS UNIDAS A MEXICO AC	0.00	0.00	45,000.00	45,000.00	45,000.00	0.00
21121021026045	ALEJANDRO PEREZ MORA	0.00	0.00	484,944.86	484,944.86	484,944.86	0.00
21121021026046	MARIA DE JESUS CASTRO SALGADO	0.00	0.00	660,587.54	660,587.54	660,587.54	0.00
21121021026047	ISRAEL ESPIRITU MORALES	0.00	0.00	4,603.60	4,603.60	4,603.60	0.00
21121021026048	JAIME RAMIREZ OBANDO	0.00	0.00	110,780.00	110,780.00	110,780.00	0.00
21121021026049	RODOLFO HERNANDEZ ABARCA	0.00	0.00	572,008.93	572,008.93	572,008.93	0.00
21121021026051	SECRETARIA DE FINANZAS Y ADMINISTRACION DEL GOBIERNO DEL ESTADO DE GUERRERO	0.00	0.00	1,457,373.94	1,457,373.94	1,457,373.94	0.00
21121021026052	JAVIER ALVAREZ CORTEZ	0.00	0.00	139,785.87	139,785.87	139,785.87	0.00
21121021026053	YUBYNAMY FIGUEROA GAYTAN	0.00	0.00	234,225.14	234,225.14	234,225.14	0.00
21121021026054	SOCIACION ESTATAL DE PADRES DE FAMILIA DE GUERRERO AC.	0.00	0.00	50,000.00	50,000.00	50,000.00	0.00
21121021026055	VIRGINIA BRITO CASTRO	0.00	0.00	231,701.54	231,701.54	231,701.54	0.00
21121021026056	PINTACOMEX, S.A. DE C.V.	0.00	0.00	202,929.48	202,929.48	202,929.48	0.00
21121021026057	MARY LAURY GALLARDO ARREOLA	0.00	0.00	351,335.94	351,335.94	351,335.94	301,709.91
21121021026058	SOCORRO EDITH DELOYA MARTINEZ	0.00	0.00	276,362.47	276,362.47	276,362.47	189,661.98
21121021026059	LAURA DIEGO TAMPA	0.00	0.00	499,030.00	499,030.00	499,030.00	116,000.00
21121021026060	EFREN BRAVO PERALTA	0.00	0.00	257,518.00	257,518.00	257,518.00	0.00
21121021026061	SUPERLA, S.A. DE C.V.	0.00	0.00	602,162.00	602,162.00	602,162.00	0.00
21121021026062	GRUPO EMPRESARIAL MARGRO SA DE CV	0.00	0.00	4,837.50	4,837.50	4,837.50	0.00
21121021026063	MAYRA ZULEIMA CONTRERAS GONZALEZ	0.00	0.00	206,022.16	206,022.16	206,022.16	0.00

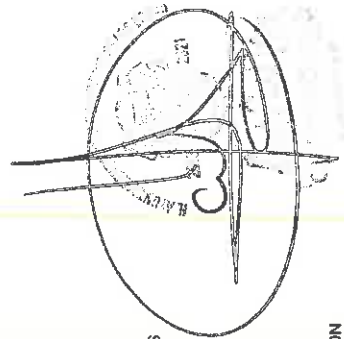

H. Ayuntamiento Municipal de Chilpancingo, Gro.  
CONTRALORIA DE FECHA MUNICIPAL



H. AYUNTAMIENTO MUNICIPAL DE CHILPANCINGO, GRO.

SECRETARIA DE FINANZAS Y ADMINISTRACION

CONSOLIDADO



BALANZA DE COMPROBACION DEL 1 DE ENERO AL 31 DE DICIEMBRE DEL 2019

C U E N T A	C O N C E P T O	SALDOS INICIALES		M O V I M I E N T O S		SALDOS ACUMULADOS	
		AL 1 DE ENERO DE 2019		ENERO - DICIEMBRE 2019		AL 31 DE DICIEMBRE DE 2019	
		DEBE	HABER	DEBE	HABER	DEBE	HABER
21121021026084	HERNANDO MAURICIO ANZALDUA CATALAN	0.00	0.00	20,880.00	20,880.00	20,880.00	0.00
21121021026085	ADOLFO DIAZ RAMIREZ	0.00	0.00	46,052.00	46,052.00	46,052.00	0.00
21121021026086	IRMA SANCHEZ GARCIA	0.00	0.00	65,988.00	65,988.00	65,988.00	0.00
21121021026087	JESUS ANTONIO ROBLES VALDEZ	0.00	0.00	132,129.59	132,129.59	132,129.59	0.00
21121021026088	GRUPO ROSIMAC SA DE CV	0.00	0.00	2,106,948.29	2,106,948.29	2,106,948.29	0.00
21121021026089	MODERNIZACION EN PROYECTOR INTEGRALES DE CONSTRUCCION SA DE CV	0.00	0.00	360,760.00	360,760.00	360,760.00	0.00
21121021026070	MICHELLE FIORELLA ROSAS ESCAMILLA	0.00	0.00	664,448.00	664,448.00	664,448.00	0.00
21121021026071	HECTOR MUÑOZ ORTIZ	0.00	0.00	8,816.00	8,816.00	8,816.00	0.00
21121021026072	MIRIAM DAMIAN GONZALEZ	0.00	0.00	113,244.53	113,244.53	113,244.53	0.00
21121021026073	YADIRA VIRGINIA GALLARDO CUEVAS	0.00	0.00	95,000.00	95,000.00	95,000.00	0.00
21121021026074	CARMEN DENISSE GARCIA GAMA	0.00	0.00	365,184.24	365,184.24	365,184.24	0.00
21121021026075	JUAN MANUEL ALANIS CASTRO	0.00	0.00	87,600.00	87,600.00	87,600.00	0.00
21121021026076	GABRIELA VASQUEZ SANCHEZ	0.00	0.00	67,400.00	67,400.00	67,400.00	0.00
21121021026077	ROSALIO RAMIREZ CASTRO	0.00	0.00	12,000.00	12,000.00	12,000.00	0.00
21121021026078	ERNESTO BELLO LOPEZ	0.00	0.00	32,268.00	32,268.00	32,268.00	0.00
21121021026079	CARLOS RAMIREZ GONZALEZ	0.00	0.00	32,268.00	32,268.00	32,268.00	0.00
21121021026080	JAVIER BELLO TORRES	0.00	0.00	32,268.00	32,268.00	32,268.00	0.00
21121021026081	FERNANDO ROMAN SANCHEZ	0.00	0.00	94,228.00	94,228.00	94,228.00	0.00
21121021026083	JUAN MANUEL LOPEZ VEGA	0.00	0.00	32,268.00	32,268.00	32,268.00	0.00
21121021026084	BENJAMIN GARCIA NAVA	0.00	0.00	32,268.00	32,268.00	32,268.00	0.00
21121021026085	MARCO BRIONES VASQUEZ	0.00	0.00	32,268.00	32,268.00	32,268.00	0.00
21121021026086	NORMA ANGELICA LORENZO AGUILAR	0.00	0.00	32,268.00	32,268.00	32,268.00	0.00
21121021026087	PATRICIA MELGOZA SALMERON	0.00	0.00	5,284.03	5,284.03	33,688.15	28,405.12
21121021026088	LITHO FORMAS, SA DE CV	0.00	0.00	101,919.03	101,919.03	101,919.03	0.00
21121021026089	EDGAR ANTONIO BALBUENA MIRANDA	0.00	0.00	110,780.00	110,780.00	110,780.00	0.00
21121021026091	CREACIONES GUERRERENSES SA DE CV	0.00	0.00	61,298.36	61,298.36	61,298.36	0.00
21121021026092	RODOLFO SANCHEZ AVILA	0.00	0.00	20,564.73	20,564.73	20,564.73	0.00
21121021026093	JOSE LUIS FIERRO CASTRO	0.00	0.00	23,000.00	23,000.00	23,000.00	0.00
21121021026094	ANTONIO CATALAN GARCIA	0.00	0.00	11,000.00	11,000.00	11,000.00	0.00
21121021026095	FRIQUE PATRON RIVERA	0.00	0.00	148,960.00	148,960.00	238,440.12	89,480.12
		0.00	0.00	129,675.75	129,675.75	128,675.75	0.00

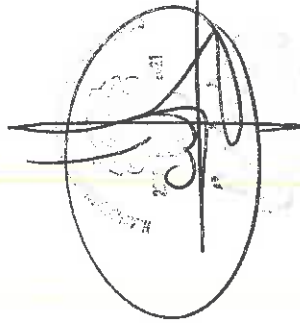

SECRETARIA DE FINANZAS Y ADMINISTRACION

25 de marzo de 2020

5:08:08 PM

Coram/ Balanza

miércoles 25 marzo 2020

H. Ayuntamiento Municipal Constitucional de Chilpancingo Gro. de México





H. AYUNTAMIENTO MUNICIPAL DE CHILPANCINGO, GRO.

SECRETARIA DE FINANZAS Y ADMINISTRACION

CONSOLIDADO

BALANZA DE COMPROBACIÓN DEL 1 DE ENERO AL 31 DE DICIEMBRE DEL 2019

C U E N T A	C O N C E P T O	SALDOS INICIALES		MOVIMIENTOS		SALDOS ACUMULADOS	
		AL 1 DE ENERO DE 2019		ENERO - DICIEMBRE 2019		AL 31 DE DICIEMBRE DE 2019	
		DEBE	HABER	DEBE	HABER	DEBE	HABER
21121021026096	COMERCIALIZADORA POLIMAS DEL SUR SA DE CV	0.00	0.00	109,000.56	146,000.56	109,000.56	37,000.00
21121021026097	HUGO PEREZ RUANO	0.00	0.00	10,296.00	10,296.00	10,296.00	0.00
21121021026098	LUIS ALBERTO LARA LUNA	0.00	0.00	23,590.48	192,927.47	192,927.47	169,336.99
21121021026099	MARGARITA NAVELI VILLEGAS FLORES	0.00	0.00	324,319.32	324,319.32	324,319.32	0.00
21121021026100	COFICO SC CONSULTORIA FISCAL Y CONTABLE	0.00	0.00	2,597,767.80	2,597,767.80	2,597,767.80	0.00
21121021026101	DAVID VALLE RODRIGUEZ	0.00	0.00	1,043,859.12	1,043,859.12	1,043,859.12	0.00
21121021026102	PEDRO JUAREZ GARZON	0.00	0.00	527,324.24	527,324.24	527,324.24	0.00
21121021026103	GERMAN IBARRA BRITO	0.00	0.00	863,531.79	863,531.79	863,531.79	0.00
21121021026104	ALEJANDRO MORALES VERGARA	0.00	0.00	947,009.09	947,009.09	947,009.09	0.00
21121021026105	COMISION DE AGUA POTABLE Y ALCANTARILLADO DE CHILPANCINGO (CAPACH)	0.00	0.00	3,740,000.00	3,740,000.00	3,740,000.00	0.00
21121021026106	EDUARDO ARCOS CASTAÑON	0.00	0.00	4,599.40	4,599.40	4,599.40	0.00
21121021026107	GRUPO NIKNIU, S.A. DE C.V.	0.00	0.00	879,213.64	879,213.64	879,213.64	0.00
21121021026108	JOSE ANTONIO FIERRO PEREZ	0.00	0.00	300,000.00	300,000.00	300,000.00	0.00
21121021026110	LUIS JOSIAS HERNANDEZ GALICIA	0.00	0.00	147,000.00	147,000.00	147,000.00	0.00
21121021026111	ANGELICA CATALAN MALDONADO	0.00	0.00	401,940.00	401,940.00	401,940.00	0.00
21121021026112	LEOPOLDINA EUGENIA DUEÑAS RIVERA	0.00	0.00	84,000.00	84,000.00	84,000.00	0.00
21121021026113	HORACIO MACIEL MEZA	0.00	0.00	8,939.80	8,939.80	8,939.80	0.00
21121021026114	JUAN FRANCISCO MARTINEZ ALONZO	0.00	0.00	8,827.60	8,827.60	8,827.60	0.00
21121021026115	JULIO CESAR CABRERA RAMIREZ	0.00	0.00	1,740.00	1,740.00	1,740.00	0.00
21121021026116	JUAN CARLOS NUÑEZ HERNANDEZ	0.00	0.00	2,128.00	2,128.00	2,128.00	0.00
21121021026117	ALILU SA DE CV	0.00	0.00	7,000.00	7,000.00	7,000.00	0.00
21121021026118	SAMUEL CASTRO CASTRO	0.00	0.00	104,081.00	104,081.00	104,081.00	0.00
21121021026119	EFRAIN RAMOS RAMIREZ	0.00	0.00	3,944.00	3,944.00	3,944.00	0.00
21121021026120	MIRIAM IBARRA RUIZ	0.00	0.00	1,191,820.28	1,191,820.28	1,191,820.28	0.00
21121021026121	DISTRIBUIDORA LIVERPOOL S.A. DE C.V.	0.00	0.00	32,849.25	32,849.25	32,849.25	0.00
21121021026122	AMED SALDIVAR TREJO	0.00	0.00	77,932.31	77,932.31	77,932.31	0.00
21121021026123	CRISTINA CENTENO RAMIREZ	0.00	0.00	35,900.59	35,900.59	35,900.59	0.00
21121021026124	ELIZA OTERO FLORES	0.00	0.00	241,654.12	241,654.12	241,654.12	0.00
21121021026125	GRUPO MULTISERVICIOS GOCAMEX SA DE CV	0.00	0.00	106,806.56	106,806.56	106,806.56	0.00
21121021026126	YANIME NAVA ROMERO	0.00	0.00	118,952.78	118,952.78	118,952.78	0.00
21121021026127	JOSE ARMELEC PIMENTEL RIVERA	0.00	0.00	145,296.45	145,296.45	145,296.45	0.00
21121021026128	KAREN YANENY NAVA MONDRAGON	0.00	0.00	112,348.29	112,348.29	112,348.29	0.00

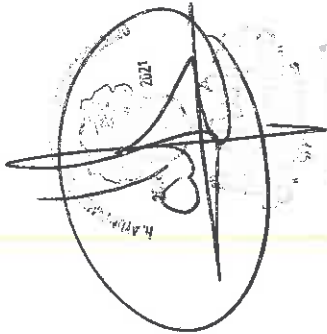



H. AYUNTAMIENTO MUNICIPAL DE CHILPANCINGO, GRO.  
SECRETARIA DE FINANZAS Y ADMINISTRACION  
CONSOLIDADO



BALANZA DE COMPROBACION DEL 1 DE ENERO AL 31 DE DICIEMBRE DEL 2019

C U E N T A	C O N C E P T O	SALDOS INICIALES		MOVIMIENTOS		SALDOS ACUMULADOS	
		AL 1 DE ENERO DE 2019		ENERO - DICIEMBRE 2019		AL 31 DE DICIEMBRE DE 2019	
		DEBE	HABER	DEBE	HABER	DEBE	HABER
21121021026129	LUIS OCTAVIO EDMUNDO UNZUETA CASTAÑON	0.00	0.00	141,581.22	141,581.22	0.00	0.00
21121021026130	EDSON MIGUEL SALDIVAR TREJO	0.00	0.00	307,041.70	307,041.70	0.00	0.00
21121021026132	COMERTRESA, S.A. DE C.V.	0.00	0.00	0.00	25,186.14	25,186.14	25,186.14
21121021026133	PEDRO SOLACHE RODRIGUEZ	0.00	0.00	0.00	10,500.00	10,500.00	10,500.00
21121021026134	REY URGEOL GARCIA VICARIO	0.00	0.00	121,173.82	121,173.82	0.00	0.00
21121021026135	ROSALBA MONTIEL SERVIN	0.00	0.00	0.00	36,540.00	36,540.00	36,540.00
21121021026136	SILVANO ROSAS BENITEZ	0.00	0.00	683,223.86	683,223.86	0.00	0.00
21121021026137	FRAZUL CORP S.A. DE C.V	0.00	0.00	0.00	517,360.00	517,360.00	517,360.00
21121021026138	COMERCIALIZADORA EL MURO AZUL	0.00	0.00	2,535,404.00	3,022,904.00	487,500.00	487,500.00
21121021026139	INFRAESTRUCTURA Y EDIFICACION YOLUEMI SA DE CV	0.00	0.00	30,624.00	30,624.00	0.00	0.00
21121021026140	GUSTAVO BUSTAMANTE MARTINEZ	0.00	0.00	55,680.00	55,680.00	0.00	0.00
21121021026141	EXPO ARME COMERCIALIZADORA, SA DE CV	0.00	0.00	583,962.00	583,962.00	0.00	0.00
21121021026142	SERVICIOS PATRIMONIALES NVM SA DE CV	0.00	0.00	519,750.00	519,750.00	0.00	0.00
21121021026143	PEDRO JUAREZ GARZON	0.00	0.00	234,900.00	234,900.00	0.00	0.00
21121021026145	EUGENIA CAMARGO PATRICIO	0.00	0.00	23,200.00	29,000.00	5,800.00	5,800.00
21121021026146	SERVICIO ASTUDILLO SA DE CV	0.00	0.00	49,273.50	49,273.50	0.00	0.00
21121021026147	GRUPO COMERCIAL BAGUAL SA DE CV	0.00	0.00	16,923.99	16,923.99	0.00	0.00
21121021026148	JOSE ROBERTO GONZALEZ SERRANO	0.00	0.00	232,000.00	812,000.00	580,000.00	580,000.00
21121021026149	GRUPO PLEESA ILUMINACION S.A. DE C.V.	0.00	0.00	40,658.00	40,658.00	0.00	0.00
21121021026150	GODRAV S.A. DE C.V.	0.00	0.00	295,104.00	683,984.00	388,880.00	388,880.00
21121021026151	VIVERO AGROFORESTAL RUBI SPR DE RL DE CV	0.00	0.00	116,931.00	116,931.00	0.00	0.00
21121021026152	COMERCIALIZADORA Y CONSTRUCCIONES CHILAPA, S.A. DE C.V.	0.00	0.00	310,466.65	310,466.65	0.00	0.00
21121021026153	DANIEL EDUARDO CALDERON AREVALO	0.00	0.00	118,900.00	118,900.00	0.00	0.00
21121021026155	ARMANDO SALGADO PEREZ	0.00	0.00	10,904.00	10,904.00	0.00	0.00
21121021026156	FRANCISCO EDELO RAMIREZ TORALVA	0.00	0.00	50,000.00	50,000.00	0.00	0.00
21121021026157	OSCAR DANIEL CASTRO ACEVEDO	0.00	0.00	10,440.00	10,440.00	0.00	0.00
21121021026158	EMILIO IGNACIO ORTIZ URIBE	0.00	0.00	106,720.00	106,720.00	0.00	0.00
21121021026159	EMILIO THALIA NAVA MARINO	0.00	0.00	600.00	600.00	0.00	0.00
21121021026160	AC JACARANDAS S.A. DE C.V.	0.00	0.00	89,678.15	89,678.15	0.00	0.00
21121021026161	GRUPO INDUSTRIAL ELECTRIC GUE SA DE CV	0.00	0.00	0.00	138,152.61	138,152.61	138,152.61

*[Handwritten signature]*





H. AYUNTAMIENTO MUNICIPAL DE CHILPANCINGO, GRO.

SECRETARIA DE FINANZAS Y ADMINISTRACION

CONSOLIDADO



BALANZA DE COMPROBACIÓN DEL 1 DE ENERO AL 31 DE DICIEMBRE DEL 2019

C U E N T A	C O N C E P T O	SALDOS INICIALES		MOVIMIENTOS		SALDOS ACUMULADOS	
		AL 1 DE ENERO DE 2019		ENERO - DICIEMBRE 2019		AL 31 DE DICIEMBRE DE 2019	
		DEBE	HABER	DEBE	HABER	DEBE	HABER
21121021026162	COMERCIAL MITO SA DE CV	0.00	0.00	0.00	156,605.67	156,605.67	0.00
21121021026163	MARILU VILLALVA SOSA	0.00	0.00	0.00	44,474.40	44,474.40	0.00
21121021026164	ARQUIMIDES HERNANDEZ SILVA	0.00	0.00	0.00	20,798.80	20,798.80	0.00
21121021026165	MARISOL ROBLES VELAZQUEZ	0.00	0.00	0.00	23,000.02	23,000.02	0.00
21121021026166	SERVICIOS GUBERNAMENTALES SERVILEX S.A. DE C.V.	0.00	0.00	255,780.19	255,780.19	0.00	0.00
21121021026167	ORALIA SALGADO SALGADO	0.00	0.00	101,500.00	101,500.00	0.00	0.00
21121021026168	ANTONIO ANTAÑO MORENO	0.00	0.00	166,620.00	166,620.00	0.00	0.00
21121021026169	ZAYRA FLORES RIOS	0.00	0.00	21,518.00	21,518.00	0.00	0.00
21121021026170	AMAIRANI ARCOS NAJERA	0.00	0.00	10,440.00	10,440.00	0.00	0.00
21121021026171	ORGANIZACION CONURBA, S.A. DE C.V.	0.00	0.00	500,000.00	500,000.00	1,680,000.00	0.00
21121021026172	CAVACOMER S.A. DE C.V.	0.00	0.00	172,130.93	172,130.93	1,180,000.00	0.00
21121021026173	VICTOR JORDAN ALVAREZ	0.00	0.00	0.00	115,000.00	115,000.00	0.00
21121021026174	MARIA RODRIGUEZ LOPEZ	0.00	0.00	0.00	168,856.28	168,856.28	0.00
21121021026175	JEAZAR DIAZ MARTINEZ	0.00	0.00	0.00	40,000.00	40,000.00	0.00
21121021026176	COMERCIO INTERNACIONAL SANCOA SA DE CV	0.00	0.00	0.00	26,680.00	26,680.00	0.00
21121021026177	GUADALUPE TORRES MARTINEZ	0.00	0.00	0.00	10,878.85	10,878.85	0.00
21121021026178	ALICIA SOLIS MORENO	0.00	0.00	0.00	7,825.00	7,825.00	0.00
21121021026999	VARIOS	0.00	0.00	5,684,962.54	5,684,962.54	0.00	0.00
21121022	FONDO INFRAESTRUCTURA SOCIAL DE LOS MUNICIPIOS FISM EJERCICIO 2017	457,323.90	457,323.90	3,191,213.60	3,191,213.60	457,323.90	457,323.90
21121022022	LEUCADIO ROBERTO VENTURA CASIANO	457,323.90	457,323.90	0.00	0.00	0.00	0.00
21121022022006	SILVANO ROSAS BENITEZ	394,499.30	394,499.30	0.00	0.00	394,499.30	0.00
21121022022008	21 HOMERO RUEDA NERIA	4,324.60	4,324.60	0.00	0.00	4,324.60	0.00
21121022022009	EJERCICIO 2019	58,500.00	58,500.00	0.00	0.00	58,500.00	0.00
21121022026	SEISMOCONTROL SA DE CV	0.00	0.00	3,191,213.60	3,191,213.60	0.00	0.00
21121022026001	YADIRA RAMIREZ RAMIREZ	0.00	0.00	264,897.60	264,897.60	0.00	0.00
21121022026002	COMERCIALIZADORA COSTERA VAMOS SA DE CV	0.00	0.00	875,600.10	875,600.10	0.00	0.00
21121022026003	VACOMEZ SA DE CV	0.00	0.00	1,406,000.00	1,406,000.00	0.00	0.00
21121022026004	VARIOS	0.00	0.00	642,627.90	642,627.90	0.00	0.00
21121022026999	FONDO DE APORT P/FORT DE LOS MPIOS EJERCICIO 2015-2018	0.00	0.00	2,088.00	2,088.00	0.00	0.00
21121023	SERVANDO DE JESUS SALGADO GUZMAN	1,033,951.02	1,033,951.02	58,951,106.19	58,951,106.19	8,508,519.88	0.00
21121023020		230,993.60	230,993.60	0.00	0.00	230,993.60	0.00
21121023020015		230,993.60	230,993.60	0.00	0.00	230,993.60	0.00

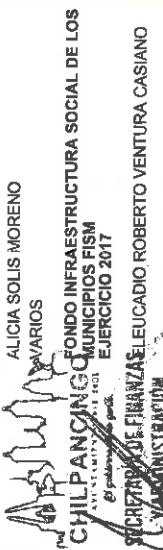
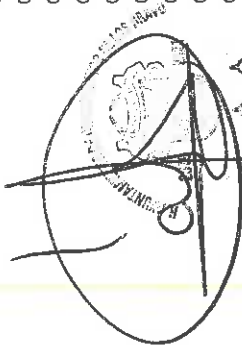

H. Ayuntamiento Municipal de Chilpancingo, Gro. Contraloría Interna



H. AYUNTAMIENTO MUNICIPAL DE CHILPANCINGO, GRO.  
SECRETARIA DE FINANZAS Y ADMINISTRACION

CONSOLIDADO



BALANZA DE COMPROBACIÓN DEL 1 DE ENERO AL 31 DE DICIEMBRE DEL 2019

C U E N T A	C O N C E P T O	SALDOS INICIALES		M O V I M I E N T O S		SALDOS ACUMULADOS	
		AL 1 DE ENERO DE 2019		ENERO - DICIEMBRE 2019		AL 31 DE DICIEMBRE DE 2019	
		DEBE	HABER	DEBE	HABER	DEBE	HABER
	<b>EJERCICIO 2016</b>		519,341.29		0.00		519,341.29
21121023021003	MA. NATIVIDAD VILLEDA GONZALEZ		35,185.50		0.00		35,185.50
21121023021004	ALFREDO MARTINEZ MARIN		7,073.39		0.00		7,073.39
21121023021006	ROSENDO RENDON LUCAS		4,941.60		0.00		4,941.60
21121023021007	JAIMÉ MARTÍN CHAVEZ MARQUEZ		129,427.00		0.00		129,427.00
21121023021011	SERVANDO DE JESUS SALGADO GUZMAN		96,178.12		0.00		96,178.12
21121023021012	JOSE BRISEÑO GODINEZ		2,664.29		0.00		2,664.29
21121023021013	SILVANO ROSAS BENITEZ		95,432.21		0.00		95,432.21
21121023021016	MARIBEL JULIAN CATALAN		56,346.35		0.00		56,346.35
21121023021018	ALBERTO MARTINEZ MARCELO		800.01		0.00		800.01
21121023021020	JOSE ROBERTO CARBAJAL BELLO		9,860.00		0.00		9,860.00
21121023021036	OLIVER ROJAS HERNANDEZ		23,423.84		0.00		23,423.84
21121023021042	MARIBEL TOLEDO FRANCISCO		4,100.60		0.00		4,100.60
21121023021052	ANAID ELIZABETH ZAMBRANO VELAZQUEZ		54,103.38		0.00		54,103.38
21121023021064	RAFAEL RODRIGUEZ MACEDONIO		5.00		0.00		5.00
<b>21121023022</b>	<b>EJERCICIO 2017</b>		18.80		18.80		0.00
21121023022025	MARIA ISABEL SANTAGRUZ RAMIREZ		18.80		18.80		0.00
<b>21121023024</b>	<b>EJERCICIO 2018</b>		1,971.90		0.00		1,971.90
21121023024001	GRUPO GASO GUERRERO S.A DE C.V		1,971.90		0.00		1,971.90
<b>21121023025</b>	<b>EJERCICIO 2018 (NVA. ADMINISTRACION)</b>		281,625.43		720,076.05		438,450.62
21121023025001	MARGALIT BAILON MIRANDA		2,632.95		2,632.95		0.00
21121023025002	REY URGEOL GARCIA VICARIO		65,279.36		65,279.36		0.00
21121023025003	JESUS ANTONIO ROBLES VALDEZ		53,398.28		53,398.28		0.00
21121023025009	KAREN YULIENY NAVA MONDRAGON		19,182.92		19,182.92		0.00
21121023025010	LUIS OCTAVIO EDMUNDO UNZUETA CASTAÑON		53,972.48		53,972.48		0.00
21121023025011	ANEL CONTRERAS ACOSTA		44,560.00		44,560.00		0.00
21121023025012	ELIZA OTERO FLORES		7,382.78		7,382.78		0.00
21121023025013	MARIAM DAMIAN GONZALEZ		29,677.36		29,677.36		0.00
21121023025020	EDGARDO ASTUDILLO MORALES		5,539.30		443,113.23		0.00
21121023025999	MARIOS		0.00		876.69		0.00
<b>21121023026</b>	<b>EJERCICIO 2019</b>		0.00		58,231,011.54		7,756,213.09
21121023026001	CABLEMAS TELECOMUNICACIONES S.A DE S.V		0.00		9,610.01		1,215.00
21121023026002	EDGARDO ASTUDILLO MORALES		0.00		9,022,386.14		385,922.32

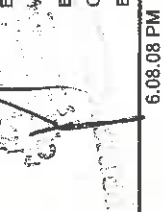
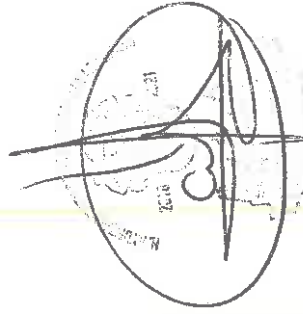

H. Ayuntamiento Municipal de Chilpancingo, Gro.  
C.O.B. (F.R.) - Contador Público de Chequeos



H. AYUNTAMIENTO MUNICIPAL DE CHILPANCINGO, GRO.

SECRETARIA DE FINANZAS Y ADMINISTRACION

CONSOLIDADO



BALANZA DE COMPROBACION DEL 1 DE ENERO AL 31 DE DICIEMBRE DEL 2019

C U E N T A	C O N C E P T O	SALDOS INICIALES		MOVIMIENTOS		SALDOS ACUMULADOS	
		AL 1 DE ENERO DE 2019		ENERO - DICIEMBRE 2019		AL 31 DE DICIEMBRE DE 2019	
		DEBE	HABER	DEBE	HABER	DEBE	HABER
21121023026003	SEGUROS ARGOS S.A DE C.V	0.00	0.00	1,006,965.46	1,006,965.46	0.00	0.00
21121023026004	LUCIA GONZALEZ DE LA CRUZ	0.00	0.00	2,288,831.80	2,288,831.80	0.00	0.00
21121023026005	JESUS ANTONIO ROBLES VALDES	0.00	0.00	672,434.12	672,434.12	0.00	0.00
21121023026006	IDEN SECURE S.A DE C.V	0.00	0.00	356,992.46	356,992.46	0.00	0.00
21121023026007	JESUS BATALLA ADAME	0.00	0.00	22,800.00	22,800.00	0.00	0.00
21121023026008	COMERCIALIZADORA GENERAL DE LA MONTAÑA SA DE CV	0.00	0.00	98,182.40	137,158.40	0.00	38,976.00
21121023026009	COMISION FEDERAL DE ELECTRICIDAD	0.00	0.00	7,179,400.22	7,179,400.22	0.00	0.00
21121023026010	SERIN CONSTRUCCION Y TECNOLOGIA SA DE CV	0.00	0.00	1,798,000.00	1,798,000.00	0.00	0.00
21121023026011	MICHELLE FLORELLA ROSAS ESCAMILLA	0.00	0.00	4,632,469.35	10,386,521.40	0.00	5,854,052.05
21121023026012	SOCORRO EDITH DELOYA MARTINEZ	0.00	0.00	130,503.99	273,717.00	0.00	143,213.01
21121023026013	BELINDA CABANAS CHAVEZ	0.00	0.00	77,800.05	77,800.05	0.00	0.00
21121023026014	JOSE ANGEL ESTRADA PEREZ	0.00	0.00	1,770.00	1,770.00	0.00	0.00
21121023026015	CAVACOMER S A DE C.V	0.00	0.00	1,230,433.32	1,230,433.32	0.00	0.00
21121023026016	LAVENTIC GRUPO SA DE CV	0.00	0.00	7,389,654.50	7,389,654.50	0.00	0.00
21121023026017	TRAFICO Y SEÑALIZACION VIAL SA DE CV	0.00	0.00	227,662.60	227,662.60	0.00	0.00
21121023026018	PROVEEDORA DE INSUMOS Y SERVICIOS S.R.L. DE C.V	0.00	0.00	1,233,288.04	1,233,288.04	0.00	0.00
21121023026019	OLPAXA S.A DE C.V	0.00	0.00	3,596,000.00	3,596,000.00	0.00	0.00
21121023026020	SERVICIO ALSO SA DE CV	0.00	0.00	30,680.10	30,680.10	0.00	0.00
21121023026021	MODERNIZACION EN PROYECTOS INTEGRAL DE CONSTRUCCION SA DE CV	0.00	0.00	1,994,596.80	1,994,596.80	0.00	0.00
21121023026023	MIRIAM DAMIAN GONZALEZ	0.00	0.00	7,272.04	7,272.04	0.00	0.00
21121023026024	PATRICIA MELGOZA SALMERON	0.00	0.00	2,717.18	2,717.18	0.00	0.00
21121023026025	KAREN YULIENY NAVA MONDRAGON	0.00	0.00	90,480.00	90,480.00	0.00	0.00
21121023026026	REY URGEOL GARCIA VICARIO	0.00	0.00	593.76	593.76	0.00	0.00
21121023026027	MARGARITA NAYELI VILLEGAS FLORES	0.00	0.00	42,177.60	42,177.60	0.00	0.00
21121023026028	CARLOS RICARDO SANCHEZ ARANDA	0.00	0.00	10,298.88	10,298.88	0.00	0.00
21121023026029	GRUPO ROSIMAC SA DE CV	0.00	0.00	940,172.55	940,172.55	0.00	0.00
21121023026030	OFICE CENTER SA DE CV	0.00	0.00	1,213,894.00	1,213,894.00	0.00	0.00
21121023026032	SECRETARIA DE FINANZAS Y ADMINISTRACION DEL GOBIERNO DEL ESTADO	0.00	0.00	812,545.06	812,545.06	0.00	0.00
21121023026033	KAREN NAYELI GOMEZ DIAZ	0.00	0.00	2,644,206.55	3,917,756.95	0.00	1,273,552.40
21121023026034	COMERCIALIZADORA EL MURO AZUL	0.00	0.00	116,000.00	116,000.00	0.00	0.00
21121023026035	SARO VERDE SA DE CV	0.00	0.00	527,288.85	527,288.85	0.00	0.00

2019  
2020  
2021

AYUNTAMIENTO MUNICIPAL DE CHILPANCINGO  
SECRETARIA DE FINANZAS Y ADMINISTRACION

AYUNTAMIENTO MUNICIPAL Constitucional de Chilpancingo, Gro.  
CONTRALORIA INTERNA MUNICIPAL





H. AYUNTAMIENTO MUNICIPAL DE CHILPANCINGO, GRO.  
SECRETARIA DE FINANZAS Y ADMINISTRACION  
CONSOLIDADO



BALANZA DE COMPROBACIÓN DEL 1 DE ENERO AL 31 DE DICIEMBRE DEL 2019

C U E N T A	C O N C E P T O	SALDOS INICIALES		MOVIMIENTOS		SALDOS ACUMULADOS	
		AL 1 DE ENERO DE 2019		ENERO - DICIEMBRE 2019		AL 31 DE DICIEMBRE DE 2019	
		DEBE	HABER	DEBE	HABER	DEBE	HABER
21121023026036	JUAN FRANCISCO MARTINEZ ALONZO	0.00	0.00	327,468.08	327,468.08	327,468.08	0.00
21121023026037	EDGAR RODRIGUEZ SANCHEZ	0.00	0.00	423,000.00	423,000.00	423,000.00	0.00
21121023026038	ALDO URIEL RAMIREZ VELAZQUEZ	0.00	0.00	30,300.00	30,300.00	30,300.00	0.00
21121023026039	CARLOS ALBERTO SUCK BELLO	0.00	0.00	5,000.00	5,000.00	5,000.00	0.00
21121023026040	AMED SALDIVAR TREJO	0.00	0.00	7,645.75	7,645.75	7,645.75	0.00
21121023026041	EDSON MIGUEL SALDIVAR TREJO	0.00	0.00	339,649.74	339,649.74	339,649.74	0.00
21121023026042	GRUPO MULTISERVICIOS GOCAMEX SA DE CV	0.00	0.00	17,079.55	17,079.55	17,079.55	0.00
21121023026043	LUIS OCTAVIO EDMUNDO UNZUETA CASTAÑON	0.00	0.00	118,157.60	118,157.60	118,157.60	0.00
21121023026044	NORMA ANGELICA LORENZO AGUILAR	0.00	0.00	0.00	0.00	0.00	0.00
21121023026046	PEDRO SOLACHE RODRIGUEZ	0.00	0.00	0.00	0.00	0.00	0.00
21121023026047	JOSE ABIMELEC PIMENTEL RIVERA	0.00	0.00	0.00	0.00	0.00	0.00
21121023026048	EDGAR GALINDO ORTEGA FELIX	0.00	0.00	47,687.60	47,687.60	47,687.60	0.00
21121023026053	SALVADOR RAMIREZ VELAZQUEZ	0.00	0.00	124,200.01	124,200.01	124,200.01	0.00
21121023026056	JAIIME NAVA ROMERO	0.00	0.00	427,539.99	427,539.99	427,539.99	0.00
21121023026051	PEDRO ORTEGA FELIX	0.00	0.00	6,171.20	6,171.20	6,171.20	0.00
21121023026052	CRALIA SALGADO SALGADO	0.00	0.00	347,000.00	347,000.00	347,000.00	0.00
21121023026053	SERVICIOS PATRIMONIALES JVM SA DE CV	0.00	0.00	565,500.00	565,500.00	565,500.00	0.00
21121023026054	SERVICIO ASTUDILLO SA DE CV	0.00	0.00	252,450.00	252,450.00	252,450.00	0.00
21121023026056	JUAN FRANCISCO SIGUENZA SERRANO	0.00	0.00	3,026.80	3,026.80	3,026.80	0.00
21121023026057	OMAR DAVID JAIMES NAVA	0.00	0.00	30,457.99	30,457.99	30,457.99	0.00
21121023026058	JOSE GERALDO DE BARRIOS	0.00	0.00	1,598.00	1,598.00	1,598.00	0.00
21121023026059	HORACIO MACIEL MEZA	0.00	0.00	13,600.00	13,600.00	13,600.00	0.00
21121023026060	SAMUEL CASTRO CASTRO	0.00	0.00	15,138.00	15,138.00	15,138.00	0.00
21121023026061	ANEL CONTRERAS ACOSTA	0.00	0.00	38,976.00	38,976.00	38,976.00	0.00
21121023026062	CONSTRUCCIONES E INSTALACIONES FIEVER SA DE CV	0.00	0.00	11,300.00	11,300.00	11,300.00	0.00
21121023026063	TELEFONOS DE MEXICO S.A.B DE C.V	0.00	0.00	25,000.00	25,000.00	25,000.00	0.00
21121023026064	AC JACARANDA S.A. DE C.V.	0.00	0.00	21,411.31	21,411.31	21,411.31	0.00
				15,483.40	15,483.40	15,483.40	0.00
				3,132.00	3,132.00	3,132.00	0.00
				1,200.00	1,200.00	1,200.00	0.00

Handwritten signature and official stamp of the Secretary of Finance and Administration.



Ayuntamiento Municipal Constitucional de Chilpancingo, Gro.  
SECRETARIA DE FINANZAS Y ADMINISTRACION



H. AYUNTAMIENTO MUNICIPAL DE CHILPANCINGO, GRO.

SECRETARIA DE FINANZAS Y ADMINISTRACION

CONSOLIDADO



BALANZA DE COMPROBACION DEL 1 DE ENERO AL 31 DE DICIEMBRE DEL 2019

C U E N T A	C O N C E P T O	SALDOS INICIALES		MOVIMIENTOS		SALDOS ACUMULADOS	
		AL 1 DE ENERO DE 2019		ENERO - DICIEMBRE 2019		AL 31 DE DICIEMBRE DE 2019	
		DEBE	HABER	DEBE	HABER	DEBE	HABER
21121023026066	DAVID MAXILIMILIANO CASTILLO VEGA ESPINOZA	0.00	0.00	193,971.00	248,921.31	193,971.00	54,950.31
21121023026067	FELIX LITO AMBROSIO	0.00	0.00	4,500,000.00	4,500,000.00	4,500,000.00	0.00
21121023026999	VARIOS	0.00	0.00	1,014,111.49	1,014,111.49	1,014,111.49	0.00
21121025	FORTASEG	1,713,158.83	1,390,183.20	24,976,384.65	24,798,409.02	24,976,384.65	1,535,183.20
21121025022	EJERCICIO 2017	0.00	0.00	0.00	0.00	0.00	1,390,183.20
21121025022004	CASSIDIAN MEXICO SA DE CV	117,183.20	117,183.20	0.00	0.00	117,183.20	0.00
21121025022005	CONSEJO ESTATAL DE SEGURIDAD PUBLICA	1,273,000.00	1,273,000.00	0.00	0.00	1,273,000.00	0.00
21121025023	EJERCICIO 2017 (ADMON NVA OCT-DIC/17)	145,000.00	145,000.00	0.00	0.00	145,000.00	0.00
21121025023001	S.S.P. ACADEMIA REGIONAL DE SEGURIDAD PUBLICA DEL CENTRO	20,000.00	20,000.00	0.00	0.00	20,000.00	0.00
21121025023002	CONSEJO ESTATAL DE SEGURIDAD PUBLICA	125,000.00	125,000.00	0.00	0.00	125,000.00	0.00
21121025025	EJERCICIO 2018 (NVA ADMON 2018-2021)	177,975.63	177,975.63	177,975.63	0.00	177,975.63	0.00
21121025025006	399 PROJECT DEVELOPMENT SA DE CV	177,975.63	177,975.63	177,975.63	0.00	177,975.63	0.00
21121025025026	EJERCICIO 2019	0.00	0.00	24,798,409.02	24,798,409.02	24,798,409.02	0.00
21121025025002	PROSOTEL DE MEXICO SA DE CV	0.00	0.00	6,166,100.03	6,166,100.03	6,166,100.03	0.00
21121025025003	BITZAES INDUSTRIES SA DE CV	0.00	0.00	518,299.53	518,299.53	518,299.53	0.00
21121025025004	GOBIERNO DEL ESTADO DE DURANGO	0.00	0.00	516,600.00	516,600.00	516,600.00	0.00
21121025025005	NYX CREAMDC SOLUCIONES SA DE CV	0.00	0.00	100,000.00	100,000.00	100,000.00	0.00
21121025025006	BELLO ANGEL Y ASOCIADOS S DE RL DE CV	0.00	0.00	4,754,801.00	4,754,801.00	4,754,801.00	0.00
21121025026007	CORONEL CONSULTORA S.C	0.00	0.00	4,664,695.76	4,664,695.76	4,664,695.76	0.00
21121025026008	BODY ARMOR BSJC SAS DE CV	0.00	0.00	8,072,912.70	8,072,912.70	8,072,912.70	0.00
21121025026009	GRUPO DATEVI SA DE CV	0.00	0.00	5,000.00	5,000.00	5,000.00	0.00
2113	CONTRATISTAS POR OBRAS PÚBLICAS POR PAGAR A CORTO PLAZO	20,413,343.38	20,413,343.38	141,140,751.81	141,140,751.81	158,863,643.63	38,136,235.20
21131	BIENES DE DOMINIO PÚBLICO POR PAGAR A CP	20,413,343.38	20,413,343.38	141,140,751.81	141,140,751.81	158,863,643.63	38,136,235.20
21131022	FONDO DE APOYO PINFRA SOC MPAL	17,210,997.99	17,210,997.99	138,393,374.01	138,393,374.01	155,116,265.83	34,933,889.81
21131022021	EJERCICIO 2016	978,331.16	978,331.16	0.00	0.00	978,331.16	0.00
21131022021014	INGENIERIA Y ARQUITECTURA HERNANDEZ SA DE CV	520,474.13	520,474.13	0.00	0.00	520,474.13	0.00
21131022021020	CONSTRUCCIONES PUENTES Y CAMINOS SHAGA SA DE CV	73,054.42	73,054.42	0.00	0.00	73,054.42	0.00
21131022021031	CONSTRUCTORA MORAYMA SA DE CV	48,334.58	48,334.58	0.00	0.00	48,334.58	0.00
21131022021042	INFRAESTRUCTURA KARANDRE CONSTRUCTORA SA DE CV	247,711.34	247,711.34	0.00	0.00	247,711.34	0.00
21131022021046	DESARROLLO E INGENIERIA DE PROYECTOS CIVAM SA DE CV	88,756.69	88,756.69	0.00	0.00	88,756.69	0.00



H. AYUNTAMIENTO MUNICIPAL DE CHILPANCINGO, GRO.

SECRETARIA DE FINANZAS Y ADMINISTRACION

CONSOLIDADO



BALANZA DE COMPROBACIÓN DEL 1 DE ENERO AL 31 DE DICIEMBRE DEL 2019

C U E N T A	C O N C E P T O	SALDOS INICIALES		MOVIMIENTOS		SALDOS ACUMULADOS	
		AL 1 DE ENERO DE 2019		ENERO - DICIEMBRE 2019		AL 31 DE DICIEMBRE DE 2019	
		DEBE	HABER	DEBE	HABER	DEBE	HABER
2 1 1 3 1 0 2 2 0 2 2	EJERCICIO 2017		15,682,602.18	0.00	0.00	15,682,602.18	
2 1 1 3 1 0 2 2 0 2 1	COMERCIALIZADORA ELECTRICA DE GUERRERO S.A DE C.V		132,240.00	0.00	0.00	132,240.00	
2 1 1 3 1 0 2 2 0 2 3	SELENIC CONSTRUCCIONES SA DE CV		766,940.97	0.00	0.00	766,940.97	
2 1 1 3 1 0 2 2 0 2 8	JOSE DE JESUS OLIVARES XICATL		272,844.83	0.00	0.00	272,844.83	
2 1 1 3 1 0 2 2 0 2 8	CONSTRUCTORA IRJAM SA DE CV		268,573.00	0.00	0.00	268,573.00	
2 1 1 3 1 0 2 2 0 1 0	CONSTRUCTORA MORAYMA SA DE CV		949,770.23	0.00	0.00	949,770.23	
2 1 1 3 1 0 2 2 0 2 0 1 1	GRUPO CONSTRUCTOR YIVALE SA DE CV		270,000.00	0.00	0.00	270,000.00	
2 1 1 3 1 0 2 2 0 2 0 1 3	GAVIONES GEOTEXTILES Y GEOSINTETICOS SA DE CV		49,209.86	0.00	0.00	49,209.86	
2 1 1 3 1 0 2 2 0 2 0 1 7	ENCORT ARQUITECTOS SA DE CV		181,933.21	0.00	0.00	181,933.21	
2 1 1 3 1 0 2 2 0 2 0 1 9	EDIFICADORA CAMINOS DOS M. SA DE CV		398,684.29	0.00	0.00	398,684.29	
2 1 1 3 1 0 2 2 0 2 0 2 0	HIDROSISTEMAS TEMIXCO S DE RL DE CV		993,965.52	0.00	0.00	993,965.52	
2 1 1 3 1 0 2 2 0 2 0 2 1	CRONO DESARROLLO DE INGENIERIA SA DE CV		272,844.83	0.00	0.00	272,844.83	
2 1 1 3 1 0 2 2 0 2 0 2 2	TEXCALLI CONSTRUCCIONES SA DE CV		119,101.76	0.00	0.00	119,101.76	
2 1 1 3 1 0 2 2 0 2 0 2 3	ALVAREZ Y ALVAREZ, ARQUITECT., INGEN. Y URBANISMO SA DE CV		256,364.36	0.00	0.00	256,364.36	
2 1 1 3 1 0 2 2 0 2 0 2 4	CODEMAZATL SA DE CV		616,500.00	0.00	0.00	616,500.00	
2 1 1 3 1 0 2 2 0 2 0 2 5	CODEGRO SA DE CV		611,857.46	0.00	0.00	611,857.46	
2 1 1 3 1 0 2 2 0 2 0 2 7	JOSE REYES ORTIZ		209,495.95	0.00	0.00	209,495.95	
2 1 1 3 1 0 2 2 0 2 0 2 8	CONSORCIO HIDRAULICO Y SANITARIO SA DE CV		1,073,482.76	0.00	0.00	1,073,482.76	
2 1 1 3 1 0 2 2 0 2 0 2 9	CONSTRUCTORA E INMOBILIARIA SIETE SA DE CV		711,803.19	0.00	0.00	711,803.19	
2 1 1 3 1 0 2 2 0 2 0 3 1	EDIFICACIONES Y PROYECTOS ZARAGOZA SA DE CV		3,334,327.58	0.00	0.00	3,334,327.58	
2 1 1 3 1 0 2 2 0 2 0 3 2	CONAGOL SA DE CV		1,125,000.00	0.00	0.00	1,125,000.00	
2 1 1 3 1 0 2 2 0 2 0 3 4	DISEÑO Y CONSTRUCCIONES ENCORT SA DE CV		695,398.88	0.00	0.00	695,398.88	
2 1 1 3 1 0 2 2 0 2 0 3 5	CONSTRUCTORA LUCASA SA DE CV		499,989.54	0.00	0.00	499,989.54	
2 1 1 3 1 0 2 2 0 2 0 4 0	CONSTRUCCIONES Y MANTENIMIENTOS TRUGA DE CV		1,068,168.66	0.00	0.00	1,068,168.66	
2 1 1 3 1 0 2 2 0 2 0 4 1	ALI GERVACIO JIMENEZ		225,000.00	0.00	0.00	225,000.00	

*[Handwritten signature and stamp]*

*[Official stamp and signature]*



H. AYUNTAMIENTO MUNICIPAL DE CHILPANCINGO, GRO.  
SECRETARIA DE FINANZAS Y ADMINISTRACION

CONSOLIDADO



BALANZA DE COMPROBACIÓN DEL 1 DE ENERO AL 31 DE DICIEMBRE DEL 2019

C U E N T A	C O N C E P T O	SALDOS INICIALES		M O V I M I E N T O S		SALDOS ACUMULADOS	
		AL 1 DE ENERO DE 2019		ENERO - DICIEMBRE 2019		AL 31 DE DICIEMBRE DE 2019	
		DEBE	HABER	DEBE	HABER	DEBE	HABER
2113102202043	ERIKA MOSSO VAZQUEZ	578,179.58	0.00	0.00	0.00	578,179.58	0.00
2113102202044	FELIX ALBERTO FUENTES ARCOS	925.72	0.00	0.00	0.00	925.72	0.00
2113102202045	EJERCICIO 2017 (OCT-DIC ADMON NVA)	150,064.65	0.00	0.00	0.00	150,064.65	0.00
2113102202001	JONATHAN CRISTIAN RIOS SOLIS	150,064.65	0.00	0.00	0.00	150,064.65	0.00
2113102202024	EJERCICIO 2018	400,000.00	0.00	693,965.51	693,965.51	400,000.00	400,000.00
2113102202022	GRUPO INDUSTRIAL ELECTRIC GIE SA DE CV	0.00	0.00	693,965.51	693,965.51	0.00	0.00
2113102202040	CONSTRUCTORA HER RAM SA DE CV	400,000.00	0.00	0.00	0.00	400,000.00	0.00
2113102202026	EJERCICIO 2019	0.00	0.00	137,699,408.50	137,699,408.50	0.00	0.00
2113102202002	MODERNIZACION EN PROYECTOS INTEGRALES DE CONSTRUCCION SA DE CV	0.00	0.00	12,401,697.18	12,401,697.18	0.00	0.00
2113102202003	LUCIA GONZALEZ DE LA CRUZ	0.00	0.00	1,083,520.94	1,083,520.94	0.00	0.00
2113102202004	MAQUINARIA Y CONSTRUCCIONES DE LA SIERRA SA DE CV.	0.00	0.00	6,753,536.36	6,753,536.36	0.00	0.00
2113102202005	MARIA GUADALUPE SANTOS RAMIREZ	0.00	0.00	1,914,063.46	1,914,063.46	0.00	0.00
2113102202006	CRESCENCIANO DIAZ MEDINA	0.00	0.00	11,833,191.67	11,833,191.67	0.00	0.00
2113102202007	CARMEN DENISSE GARCIA GAMA	0.00	0.00	1,000,000.00	1,000,000.00	0.00	0.00
2113102202008	ARQUIMIDES OLIVAR REYES	0.00	0.00	360,373.57	360,373.57	0.00	0.00
2113102202009	ENESTOR RODRIGUEZ NAVEZ	0.00	0.00	906,960.95	906,960.95	0.00	0.00
2113102202010	JOSE DAVID CABAÑAS MANZANAREZ	0.00	0.00	1,517,226.35	1,517,226.35	0.00	0.00
2113102202011	EDGAR RODRIGUEZ SANCHEZ	0.00	0.00	1,968,629.84	1,968,629.84	0.00	0.00
2113102202012	SEISMOCONTROL SA DE CV	0.00	0.00	618,094.40	618,094.40	0.00	0.00
2113102202013	COMERCIALIZADORA Y CONSTRUCCIONES RYLYJR SA DE CV	0.00	0.00	582,620.48	582,620.48	0.00	0.00
2113102202014	ADULFA VAZQUEZ ROSALES	0.00	0.00	955,162.34	955,162.34	0.00	0.00
2113102202015	INGENIERIA Y ARQUITECTURA HERNANDEZ SA DE CV	0.00	0.00	104,253.35	104,253.35	0.00	0.00
2113102202016	OFER CONSTRUCCIONES S.A DE C.V	0.00	0.00	1,378,591.47	1,378,591.47	0.00	0.00
2113102202017	MICHELE FIORELLA ROSAS ESCAMILLA	0.00	0.00	2,172,070.52	2,172,070.52	0.00	0.00
2113102202019	ERIKA MOSSO VAZQUEZ	0.00	0.00	5,161,889.53	5,161,889.53	0.00	0.00
2113102202020	EDVARD ALEXIE BELTRAN REYES	0.00	0.00	5,832,754.79	5,832,754.79	0.00	0.00
2113102202022	CARLOS IVAN SALDAÑA SANCHEZ	0.00	0.00	800,000.00	800,000.00	0.00	0.00
2113102202023	ROBEN HERNANDEZ DIRCIO	0.00	0.00	2,493,828.55	2,493,828.55	0.00	0.00
2113102202024	GRUPO CORPCIT SA DE CV	0.00	0.00	4,133,914.14	4,133,914.14	0.00	0.00
2113102202025	CORPORATIVO COMERCIAL FE SA DE CV	0.00	0.00	793,405.01	793,405.01	0.00	0.00

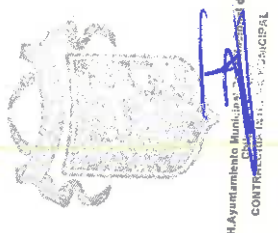
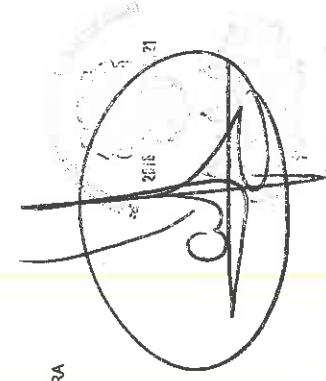



H. AYUNTAMIENTO MUNICIPAL DE CHILPANCINGO, GRO.

SECRETARIA DE FINANZAS Y ADMINISTRACION

CONSOLIDADO



BALANZA DE COMPROBACIÓN DEL 1 DE ENERO AL 31 DE DICIEMBRE DEL 2019

C U E N T A	C O N C E P T O	SALDOS INICIALES		M O V I M I E N T O S		SALDOS ACUMULADOS	
		AL 1 DE ENERO DE 2019		ENERO - DICIEMBRE 2019		AL 31 DE DICIEMBRE DE 2019	
		DEBE	HABER	DEBE	HABER	DEBE	HABER
21131022026026	DESARROLLOS DIPCA SA DE CV	0.00	0.00	2,891,647.68	3,564,560.97	672,913.28	
21131022026028	COMERCIALIZADORA Y CONSTRUCCIONES CHILAPA SA DE CV	0.00	0.00	3,802,286.94	4,564,540.31	762,253.37	
21131022026029	CAMINOS Y PAVIMENTOS DE AXOXUCA SA DE CV	0.00	0.00	1,464,930.06	1,699,101.90	234,171.74	
21131022026030	PROYECTOS Y CONSTRUCCIONES 4NS SA DE CV	0.00	0.00	1,893,151.71	1,893,151.71	0.00	
21131022026031	HORSE POWER BUILDING SA DE CV	0.00	0.00	1,987,521.57	2,071,044.87	83,523.30	
21131022026032	CONSTRUCTORA E INMOBILIARIA DIZBA SA DE CV	0.00	0.00	2,201,184.02	2,201,184.02	0.00	
21131022026033	ZURPA G.A CONSTRUCCIONES SA DE CV	0.00	0.00	2,669,898.12	2,971,578.84	301,680.72	
21131022026034	COREFRA SA DE CV	0.00	0.00	716,756.49	716,756.49	0.00	
21131022026035	COOPERATIVO DE INGENIEROS CIVILES AVICAT SA DE CV	0.00	0.00	1,118,402.05	1,118,402.05	0.00	
21131022026036	STARSKY MEZAN ANZO	0.00	0.00	1,675,459.68	2,172,166.80	496,707.12	
21131022026037	ROKO OBRA CIVIL SA DE CV	0.00	0.00	663,913.94	907,666.53	243,752.59	
21131022026038	CONSTRUCTORA Y OBRAS CIVILES MARTINEZ SA DE CV	0.00	0.00	2,085,081.65	2,812,256.71	727,175.06	
21131022026039	CERCAS Y CONSTRUCCIONES OSORIO SA DE CV	0.00	0.00	833,809.74	833,809.74	0.00	
21131022026040	GRUPO INDUSTRIAL ELECTRIC GIE SA DE CV	0.00	0.00	2,793,406.83	5,607,441.81	2,814,034.98	
21131022026041	DISEÑO Y CONSTRUCCIONES ENCORT SA DE CV	0.00	0.00	737,710.32	737,710.32	0.00	
21131022026042	ALVARADO C Y G CONSTRUYENDO SA DE CV	0.00	0.00	1,813,117.00	2,944,380.87	1,131,263.87	
21131022026043	OFICE CENTER SA DE CV	0.00	0.00	868,487.58	1,049,896.49	181,408.91	
21131022026044	O.P.D COMISION DE INFRAESTRUCTURA CARRETERA Y AEROPORTUARIA DEL ESTADO DE GUERRERO	0.00	0.00	15,000,000.00	15,000,000.00	0.00	
21131022026045	MALLAS GRO S.A. DE C.V.	0.00	0.00	1,210,494.29	1,736,834.70	526,340.41	
21131022026046	CODEGRO S.A. DE C.V.	0.00	0.00	1,337,393.86	1,568,567.44	231,173.58	
21131022026047	AVENLY ALEJANDRA AGUILAR ALMAZAN	0.00	0.00	1,139,684.21	1,376,405.97	236,721.76	
21131022026048	OBRAS DE INFRAESTRUCTURA BAIFER SA DE CV	0.00	0.00	699,916.67	1,595,869.56	895,952.89	
21131022026049	ALILECOM SA DE CV	0.00	0.00	856,987.41	1,080,173.54	123,186.13	
21131022026050	ALUM & GRUPO SA DE CV	0.00	0.00	1,317,780.06	1,317,780.06	0.00	
21131022026051	GRUPO BELLATOR SA DE CV	0.00	0.00	726,809.94	860,693.49	133,883.55	

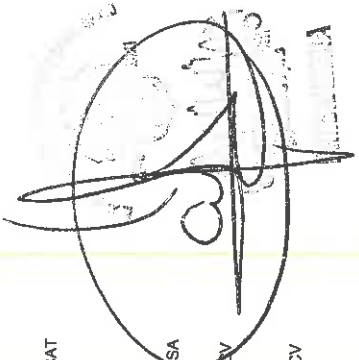

H. Ayuntamiento Municipal de Chilpancingo, Gro. Contraloría Municipal





H. AYUNTAMIENTO MUNICIPAL DE CHILPANCINGO, GRO.  
SECRETARIA DE FINANZAS Y ADMINISTRACION  
CONSOLIDADO



BALANZA DE COMPROBACION DEL 1 DE ENERO AL 31 DE DICIEMBRE DEL 2019

C U E N T A	C O N C E P T O	SALDOS INICIALES		M O V I M I E N T O S		SALDOS ACUMULADOS	
		AL 1 DE ENERO DE 2019		ENERO - DICIEMBRE 2019		AL 31 DE DICIEMBRE DE 2019	
		DEBE	HABER	DEBE	HABER	DEBE	HABER
21131022026052	MIGUEL SALGADO OBISPO	0.00	0.00	1,613,105.25	1,768,099.76	154,994.51	
21131022026053	KAREN NAYELI GOMEZ DIAZ	0.00	0.00	3,227,639.28	3,227,639.28	0.00	
21131022026054	CLIPCON SA DE CV	0.00	0.00	344,658.05	1,146,860.15	804,202.10	
21131022026055	IGA CONSTRUCTORA E INMOBILIARIA, ARRENDADORA Y COMERCIALIZADORA S.A DE C. V.	0.00	0.00	2,245,713.62	3,476,398.89	1,230,685.27	
21131022026056	INNOVA Y TRANSFORMA ALTER S.A DE C.V.	0.00	0.00	3,488,193.23	5,329,581.70	1,841,388.47	
21131022026057	VAZQUEZ ROJAS ARQUITECTOS S.A DE C.V.	0.00	0.00	240,677.28	802,257.59	561,580.31	
21131022026058	CONSULTORIA ESPECIALIZADA EN INFRAESTRUCTURA S.A DE C.V.	0.00	0.00	1,264,937.79	1,264,937.79	0.00	
21131022026059	FN CONSTRUCCION Y SUPERVISION S.A DE C.V.	0.00	0.00	695,262.48	695,262.48	0.00	
21131022026060	ENOC Y ASOCIADOS S.A DE C.V.	0.00	0.00	834,038.42	1,054,793.64	220,755.22	
21131022026061	EDIFICACIONES Y CONSTRUCCIONES PANAMO S. DE C.V.	0.00	0.00	851,862.25	851,862.25	0.00	
21131022026062	CONSORCIO CONSTRUCTIVO E INMOBILIARIA GACMIT S.A DE C.V.	0.00	0.00	595,566.50	699,627.79	104,061.29	
21131022026063	CAT CONSTRUCCIONES SA DE CV	0.00	0.00	518,195.67	599,335.57	81,139.90	
21131022026064	PROYECTOS, SUPERVISION Y CONSTRUCCION GE-10 SA DE CV	0.00	0.00	1,387,411.56	1,609,808.76	222,397.20	
21131022026065	DESARROLLOS DE OBRA CIVIL Y ESTRUCTURAS S.A DE C.V.	0.00	0.00	121,712.11	405,707.02	283,994.91	
21131022026066	SECRETARIA DE FINANZAS Y CONSTRUCCIONES DE GUERRERO S.A DE C.V.	0.00	0.00	943,105.98	943,105.98	0.00	
21131022026067	ESPECIALIDADES ELECTRICAS DE GUERRERO S. A DE C.V.	0.00	0.00	656,073.73	1,053,818.43	397,744.70	
21131022026069	PROYECTOS Y ASESORIAS ROAL S.A DE C.V.	0.00	0.00	538,850.96	678,844.96	139,994.00	
21131022026070	FRANCISCO FERNANDO SANTANA ALVAREZ	0.00	0.00	300,930.11	376,840.51	75,910.40	
21131022026071	GILDARDO SOTO NAVARRETE	0.00	0.00	459,857.70	574,827.15	114,969.45	
21131023	FONDO DE APORTACION PARA EL FORTALECIMIENTO MUNICIPAL EJERCICIO 2019	0.00	0.00	840,396.80	840,396.80	0.00	
21131023026	RECURSOS HUMANOS	0.00	0.00	840,396.80	840,396.80	0.00	
21131023026999		0.00	0.00	840,396.80	840,396.80	0.00	
21131027	FORTALECE	1,813,298.82	1,813,298.82	0.00	0.00	1,813,298.82	

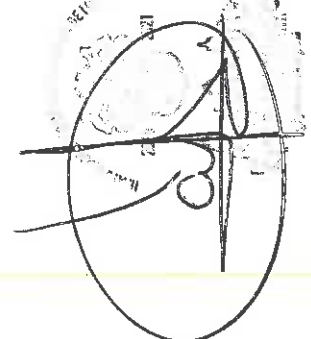

H. Ayuntamiento Municipal Chilpancingo, Gro.  
Secretaría de Finanzas y Administración  
25/03/2020



H. AYUNTAMIENTO MUNICIPAL DE CHILPANCINGO, GRO.  
SECRETARIA DE FINANZAS Y ADMINISTRACION  
CONSOLIDADO



BALANZA DE COMPROBACIÓN DEL 1 DE ENERO AL 31 DE DICIEMBRE DEL 2019

C U E N T A	C O N C E P T O	SALDOS INICIALES		MOVIMIENTOS		SALDOS ACUMULADOS	
		AL 1 DE ENERO DE 2019		ENERO - DICIEMBRE 2019		AL 31 DE DICIEMBRE DE 2019	
		DEBE	HABER	DEBE	HABER	DEBE	HABER
21131027021	EJERCICIO 2016						
21131027021001	JAVIER ABARCA CASTILLO		1,813,298.82	0.00	0.00	1,813,298.82	0.00
21131027021002	CONSTRUCCIONES E INSTALACIONES ARGACOS SA DE CV		1,442,158.05	0.00	0.00	1,442,158.05	0.00
21131030	PROG. FORTALECIM FINANCIERAS P/INVERSION RAMO 23		371,140.77	0.00	0.00	371,140.77	0.00
21131030021	EJERCICIO 2016		1,389,046.57	0.00	0.00	1,389,046.57	0.00
21131030021001	CONSTRUCCIONES Y PAVIMENTOS YOVANA SA DE CV		1,389,046.57	0.00	0.00	1,389,046.57	0.00
21131032	PROGRAMA PRODDER-CONAGUA		0.00	1,906,981.00	0.00	1,906,981.00	0.00
21131032026	EJERCICIO 2019		0.00	1,906,981.00	0.00	1,906,981.00	0.00
21131032026001	OFFICE CENTER S.A DE C.V		0.00	656,981.00	0.00	656,981.00	0.00
21131032026002	CONSORCIO HIDRAULICO Y SANITARIO S.A DE C.V		0.00	1,250,000.00	0.00	1,250,000.00	0.00
2115	TRANSFERENCIAS OTORGADAS POR PAGAR A CORTO PLAZO		0.00	31,858,433.86	0.00	31,858,433.86	0.00
21151	TRANSFERENCIAS INTERNAS Y ASIGNACIONES AL SECTOR PUBLICO		0.00	22,739,898.38	0.00	22,739,898.38	0.00
21156	AYUDAS SOCIALES		0.00	4,828,141.22	0.00	4,828,141.22	0.00
21156001	GASTO CORRIENTE		0.00	4,068,616.22	0.00	4,068,616.22	0.00
21156001026	EJERCICIO 2019		0.00	4,068,616.22	0.00	4,068,616.22	0.00
21156001026999	VIARIOS		0.00	4,068,616.22	0.00	4,068,616.22	0.00
21156007	FORTASEG		0.00	759,525.00	0.00	759,525.00	0.00
21156007026	EJERCICIO 2019		0.00	759,525.00	0.00	759,525.00	0.00
21156007026899	VIARIOS		0.00	759,525.00	0.00	759,525.00	0.00
21157	PENSIONES Y JUBILACIONES		0.00	759,525.00	0.00	759,525.00	0.00
2117	RETENCIONES Y CONTRIBUCIONES POR PAGAR A CORTO PLAZO		0.00	4,291,034.49	0.00	4,291,034.49	0.00
21171	RETENCIONES DE IMPUESTOS POR PAGAR A CP		133,596,992.55	14,778,002.92	68,713,953.90	188,532,943.53	640.23
21171003	FONDO DE APORT P/IFORT DE LOS MPIO		294,186.31	587,505.03	659,636.37	366,317.65	0.00
21171003005	ADMIN. 2012-2015		428.97	0.00	0.00	428.97	0.00
21171003005002	5 AL MILLAR INSPECCION Y VIGILANCIA		428.97	0.00	0.00	428.97	0.00
21171021	GASTO CORRIENTE		164,591.07	104,055.86	156,084.24	216,619.45	0.00
21171021020	EJERCICIO 2015-2018		10,333.35	0.00	0.00	10,333.35	0.00
21171021020002	10% SIARRENDAMIENTO DE INMUEBLES		5,000.01	0.00	0.00	5,000.01	0.00
21171021020003	10% SIARRENDAM C/P		5,333.34	0.00	0.00	5,333.34	0.00
21171021021	EJERCICIO 2016		96,887.88	0.00	0.00	96,887.88	0.00
21171021021001	10% SIHONORARIOS		16,106.99	0.00	0.00	16,106.99	0.00

2018  
2021  
2021

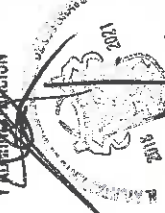
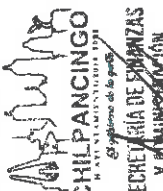

H. Ayuntamiento Municipal Chilpancingo, Gro.  
Secretaría de Finanzas y Administración



H. AYUNTAMIENTO MUNICIPAL DE CHILPANCINGO, GRO.  
SECRETARIA DE FINANZAS Y ADMINISTRACION  
CONSOLIDADO



BALANZA DE COMPROBACIÓN DEL 1 DE ENERO AL 31 DE DICIEMBRE DEL 2019

C U E N T A	C O N C E P T O	SALDOS INICIALES		MOVIMIENTOS		SALDOS ACUMULADOS	
		AL 1 DE ENERO DE 2019		ENERO - DICIEMBRE 2019		AL 31 DE DICIEMBRE DE 2019	
		DEBE	HABER	DEBE	HABER	DEBE	HABER
21171021021002	10% S/ARRENDAMIENTO DE INMUEBLES		31,599.99	0.00	0.00	0.00	31,599.99
21171021021003	IVA RETENIDO P/ARRENDAMIENTO		32,000.07	0.00	0.00	0.00	32,000.07
21171021021004	IVA RETENIDO P/HONORARIOS		17,180.83	0.00	0.00	0.00	17,180.83
21171021022	EJERCICIO 2017		2,280.72	0.00	0.00	0.00	2,280.72
21171021022005	5% AL MILLAR DE INSPECCION Y VIGILANCIA		2,280.72	0.00	0.00	0.00	2,280.72
21171021023	EJERCICIO 2017 (OCT-DIC)		2,130.77	0.00	0.00	0.00	2,130.77
21171021023005	5% AL MILLAR DE INSPECCION Y VIGILANCIA		2,130.77	0.00	0.00	0.00	2,130.77
21171021024	EJERCICIO 2018		930.28	0.00	0.00	0.00	930.28
21171021024005	5% AL MILLAR DE INSPECCION Y VIGILANCIA		930.28	0.00	0.00	0.00	930.28
21171021025	EJERCICIO 2018 NUEVA ADMINISTRACION OCT-DIC.		52,028.07	52,027.86	0.00	0.00	26,014.04
21171021025001	10% S/HONORARIOS		25,174.83	25,174.83	0.00	0.00	12,587.42
21171021025004	IVA RETENIDO P/HONORARIOS		26,853.24	26,853.03	0.00	0.00	13,426.62
21171021026	EJERCICIO 2019		0.00	52,028.00	0.00	0.00	130,070.20
21171021026001	10% S/HONORARIOS		0.00	0.00	0.00	0.00	62,937.10
21171021026003	IVA RETENIDC P/HONORARIOS		0.00	26,854.00	0.00	0.00	67,133.10
21171022	FONDO DE APORTE P/INFRA SOC MPAL		61,049.89	483,449.17	0.00	0.00	483,449.14
21171022024	EJERCICIO 2018		61,049.85	2,866.47	0.00	0.00	2,866.47
21171022024001	I.S.R. RETENIDO (HONORARIOS)		15,734.15	0.00	0.00	0.00	15,734.15
21171022024002	I.V.A. RETENIDO (HONORARIOS)		16,783.10	0.00	0.00	0.00	16,783.10
21171022024003	5% AL MILLAR DE INSPECCION Y VERIFICACION. DE OBRA		8,486.94	818.99	0.00	0.00	2,047.48
21171022024004	2% AL MILLAR DE INSPECCION Y VERIFICACION. DE OBRA		20,065.66	2,047.48	0.00	0.00	818.99
21171022025	EJERCICIO 2018 NUEVA ADMINISTRACION		0.04	0.03	0.03	0.00	0.01
21171022025003	5% AL MILLAR DE INSPECCION Y VERIFICACION. DE OBRA		0.04	0.03	0.03	0.00	0.01
21171022026	EJERCICIO 2019		0.00	480,582.67	0.00	0.00	480,582.67
21171022026003	5% AL MILLAR DE INSPECCION Y VERIFICACION. DE OBRA		0.00	480,582.67	0.00	0.00	480,582.67
21171023	FONDO DE APORTE P/IFORT DE LOS MPIO		68,116.38	0.00	0.00	0.00	5,232.31
21171023021	EJERCICIO 2016		26,477.56	0.00	0.00	0.00	0.00
21171023021001	5% AL MILLAR INSPECCION Y VIGILANCIA		26,477.56	0.00	0.00	0.00	0.00
21171023022	EJERCICIO 2017		19,628.01	0.00	0.00	0.00	0.00
21171023022001	5% AL MILLAR INSPECCION Y VIGILANCIA		19,628.01	0.00	0.00	0.00	0.00
21171023024	EJERCICIO 2018		22,010.81	0.00	0.00	0.00	0.00
21171023024001	5% AL MILLAR INSPECCION Y VIGILANCIA		22,010.81	0.00	0.00	0.00	0.00

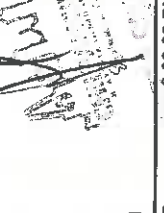
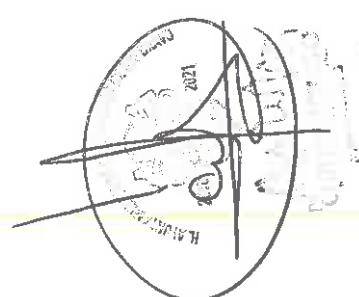

H. Ayuntamiento Municipal Constitucional de Chilpancingo, Gro.  
CONTRALORIA INTERIOR



H. AYUNTAMIENTO MUNICIPAL DE CHILPANCINGO, GRO.  
SECRETARIA DE FINANZAS Y ADMINISTRACION  
CONSOLIDADO



BALANZA DE COMPROBACIÓN DEL 1 DE ENERO AL 31 DE DICIEMBRE DEL 2019

C U E N T A	C O N C E P T O	SALDOS INICIALES		MOVIMIENTOS		SALDOS ACUMULADOS	
		AL 1 DE ENERO DE 2019		ENERO - DICIEMBRE 2019		AL 31 DE DICIEMBRE DE 2019	
		DEBE	HABER	DEBE	HABER	DEBE	HABER
21171 023 026	EJERCICIO 2019		0.00	0.00	0.00	5,232.31	5,232.31
21171 023 026 001	5 AL MILLAR INSPECCION Y VIGILANCIA		0.00	0.00	0.00	5,232.31	5,232.31
21171 030	RAMO 23 PROVISIONES SALARIALES Y ECONOMICAS Y FORTALECIMIENTO FINANCIERO		0.00	0.00	0.00	14,870.68	14,870.68
21171 030 026	EJERCICIO 2019		0.00	0.00	0.00	14,870.68	14,870.68
21171 030 026 001	5% AL MILLAR DE INSP Y VERIF. DE OBRA		0.00	0.00	0.00	14,870.68	14,870.68
21172	RETENCIONES DEL SISTEMA DE SEGURIDAD SOCIAL POR PAGAR A CP		45,106,506.44	6,982,878.52	23,885,811.29	14,870.68	14,870.68
21172 021	GASTO CORRIENTE		38,977,911.31	4,905,443.92	19,546,711.01	14,870.68	14,870.68
21172 021 020	PERIODO 2015-2018		1,161,295.29	0.00	0.00	14,870.68	14,870.68
21172 021 020 002	CUOTAS ISSSPEG		1,161,295.29	0.00	0.00	14,870.68	14,870.68
21172 021 021	EJERCICIO 2016		11,197,694.29	0.00	0.00	14,870.68	14,870.68
21172 021 021 002	CUOTAS ISSSPEG		11,197,694.29	0.00	0.00	14,870.68	14,870.68
21172 021 022	EJERCICIO 2017		9,957,398.84	0.00	0.00	14,870.68	14,870.68
21172 021 022 002	CUOTAS ISSSPEG		9,957,398.84	0.00	0.00	14,870.68	14,870.68
21172 021 023	EJERCICIO 2017 (OCT-DIC)		541,223.24	0.00	0.00	14,870.68	14,870.68
21172 021 024	CUOTAS ISSSPEG		541,223.24	0.00	0.00	14,870.68	14,870.68
21172 021 024 001	EJERCICIO 2018		11,506,483.62	1,206,355.03	31,945.68	14,870.68	14,870.68
21172 021 024 002	CUOTAS ISSSPEG		1,206,355.03	1,206,355.03	0.00	14,870.68	14,870.68
21172 021 025	EJERCICIO 2018 (NUEVA ADMINISTRACION)		10,300,128.59	0.00	0.00	14,870.68	14,870.68
21172 021 025 001	CUOTAS ISSSTE		4,613,816.03	3,216,868.05	22,545.99	14,870.68	14,870.68
21172 021 025 002	CUOTAS ISSSPEG		932,224.67	932,173.73	0.00	14,870.68	14,870.68
21172 021 026	EJERCICIO 2019		3,681,591.36	2,284,695.32	22,545.99	14,870.68	14,870.68
21172 021 026 001	CUOTAS ISSSTE		0.00	482,219.84	19,492,219.34	14,870.68	14,870.68
21172 021 026 002	CUOTAS ISSSPEG		0.00	482,219.84	4,049,268.57	14,870.68	14,870.68
21172 023	FONDO DE APORT PIFORT DE LOS MPIO		0.00	0.00	15,442,950.77	14,870.68	14,870.68
21172 023 020	EJERCICIO 2015-2018		6,128,595.13	2,077,434.60	4,339,100.28	14,870.68	14,870.68
21172 023 020 002	CUOTAS ISSSPEG		186,651.09	0.00	0.00	14,870.68	14,870.68
21172 023 021	EJERCICIO 2016		186,651.09	0.00	0.00	14,870.68	14,870.68
21172 023 021 002	CUOTAS ISSSPEG		1,927,883.04	0.00	0.00	14,870.68	14,870.68
21172 023 022	EJERCICIO 2017		1,913,383.33	0.00	0.00	14,870.68	14,870.68
21172 023 022 002	CUOTAS ISSSPEG		1,913,383.33	0.00	0.00	14,870.68	14,870.68
21172 023 024	EJERCICIO 2018		1,018,132.70	404,328.05	0.00	14,870.68	14,870.68

*[Handwritten signature]*

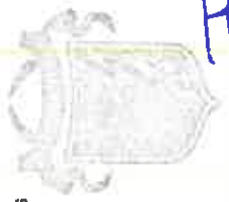
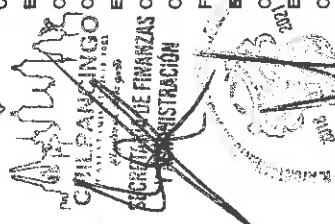

H. Ayuntamiento Municipal Consolidado  
Chilpancingo, Gro. de Jalisco, Jalisco, Jalisco





H. AYUNTAMIENTO MUNICIPAL DE CHILPANCINGO, GRO.

SECRETARIA DE FINANZAS Y ADMINISTRACION

CONSOLIDADO



BALANZA DE COMPROBACIÓN DEL 1 DE ENERO AL 31 DE DICIEMBRE DEL 2019

C U E N T A	C O N C E P T O	SALDOS INICIALES		MOVIMIENTOS		SALDOS ACUMULADOS	
		AL 1 DE ENERO DE 2019		ENERO - DICIEMBRE 2019		AL 31 DE DICIEMBRE DE 2019	
		DEBE	HABER	DEBE	HABER	DEBE	HABER
21172023024001	CUOTAS ISSSTE		404,329.05	404,329.05	0.00	0.00	0.00
21172023024002	CUOTAS ISSSPEG		613,803.65	0.00	0.00	0.00	613,803.65
21172023025	EJERCICIO 2018-2021 (NUEVA ADMINISTRACION)		1,082,544.87	1,089,856.11	0.00	0.00	12,686.86
21172023025001	CUOTAS ISSSTE		310,918.79	310,918.79	0.00	0.00	0.00
21172023025002	CUOTAS ISSSPEG		771,626.18	758,937.32	0.00	0.00	12,688.86
21172023026	EJERCICIO 2019		0.00	603,249.44	4,339,100.28	0.00	3,735,850.84
21172023026001	CUOTAS ISSSTE		0.00	157,449.69	1,226,777.28	0.00	1,069,327.59
21172023026002	CUOTAS ISSSPEG		0.00	445,799.75	3,112,323.00	0.00	2,666,523.25
21173	IMPUESTO Y DERECHOS POR PAGAR A CP		969,410.00	2,150.00	1,668,467.32	0.00	2,635,727.32
21173021	GASTO CORRIENTE		969,410.00	0.00	0.00	0.00	969,410.00
21173021021	EJERCICIO 2016		300,852.00	0.00	0.00	0.00	300,852.00
21173021021001	15% CONTRIBUCION ESTATAL SIMPUESTOS Y DERECHOS MPALES		191,613.00	0.00	0.00	0.00	191,613.00
21173021021002	10% ADMINISTRACION DE REGISTRO CIVIL		45,427.00	0.00	0.00	0.00	45,427.00
21173021021003	15% PRO-EDUCACION Y ASISTENCIA SOCIAL (APLICADOS AL REGISTRO CIVIL)		15,918.00	0.00	0.00	0.00	15,918.00
21173021021004	15% PRO-CAMINOS (APLICADOS AL REGISTRO CIVIL)		16,159.00	0.00	0.00	0.00	16,159.00
21173021021005	15% PRO-TURISMO (APLICADOS AL REGISTRO CIVIL)		15,677.00	0.00	0.00	0.00	15,677.00
21173021021006	15% PRO-RECUPERACION ECOLOGICA (APLICADOS AL REGISTRO CIVIL)		15,918.00	0.00	0.00	0.00	15,918.00
21173021021007	10% SICOBRO DE MULTAS FED NO FISCALES		140.00	0.00	0.00	0.00	140.00
21173021022	EJERCICIO 2017		486,236.00	0.00	0.00	0.00	486,236.00
21173021022001	15% CONTRIBUCION ESTATAL SIMPUESTOS Y DERECHOS MPALES		363,339.00	0.00	0.00	0.00	363,339.00
21173021022002	10% ADMINISTRACION DE REGISTRO CIVIL		53,681.00	0.00	0.00	0.00	53,681.00
21173021022003	15% PRO-EDUCACION Y ASISTENCIA SOCIAL (APLICADOS AL REGISTRO CIVIL)		17,285.00	0.00	0.00	0.00	17,285.00
21173021022004	15% PRO-CAMINOS (APLICADOS AL REGISTRO CIVIL)		17,285.00	0.00	0.00	0.00	17,285.00
21173021022005	15% PRO-TURISMO (APLICADOS AL REGISTRO CIVIL)		17,285.00	0.00	0.00	0.00	17,285.00
21173021022006	15% PRO-RECUPERACION ECOLOGICA (APLICADOS AL REGISTRO CIVIL)		17,285.00	0.00	0.00	0.00	17,285.00
21173021022007	10% SICOBRO DE MULTAS FED NO FISCALES		76.00	0.00	0.00	0.00	76.00
21173021023	EJERCICIO 2017 (OCT-DIC NVA ADMON)		18,986.00	0.00	0.00	0.00	18,986.00
21173021023001	15% CONTRIBUCION ESTATAL SIMPUESTOS Y DERECHOS MPALES		1,927.00	0.00	0.00	0.00	1,927.00
21173021023002	10% ADMINISTRACION DE REGISTRO CIVIL		5,187.00	0.00	0.00	0.00	5,187.00
21173021023003	15% PRO-EDUCACION Y ASISTENCIA SOCIAL (APLICADOS AL REGISTRO CIVIL)		2,963.00	0.00	0.00	0.00	2,963.00

*[Firma manuscrita]*



H. Ayuntamiento Municipal de Chilpancingo, Gro.  
SECRETARIA INTERNA MUNICIPAL

miércoles 25 marzo 2020

6.08.08 PM

Coram/ Balanza





H. AYUNTAMIENTO MUNICIPAL DE CHILPANCINGO, GRO.  
SECRETARIA DE FINANZAS Y ADMINISTRACION  
CONSOLIDADO



BALANZA DE COMPROBACION DEL 1 DE ENERO AL 31 DE DICIEMBRE DEL 2019

C U E N T A	C O N C E P T O	SALDOS INICIALES		MOVIMIENTOS		SALDOS ACUMULADOS	
		AL 1 DE ENERO DE 2019		ENERO - DICIEMBRE 2019		AL 31 DE DICIEMBRE DE 2019	
		DEBE	HABER	DEBE	HABER	DEBE	HABER
21173021023004	15% PRO-CAMINOS ( APLICADOS AL REGISTRO CIVIL )		2,963.00	0.00	0.00	0.00	2,963.00
21173021023005	15% PRO-TURISMO ( APLICADOS AL REGISTRO CIVIL )		2,963.00	0.00	0.00	0.00	2,963.00
21173021023006	15% PRO-RECUPERACION ECOLOGICA ( APLICADOS AL REGISTRO CIVIL )		2,963.00	0.00	0.00	0.00	2,963.00
21173021024	EJERCICIO 2018		11,938.00	0.00	0.00	0.00	11,938.00
21173021024001	DERECHOS MPALES		30,637.00	0.00	0.00	0.00	30,637.00
21173021024002	10% ADMINISTRACION DE REGISTRO CIVIL		-1,283.00	0.00	0.00	0.00	-1,283.00
21173021024003	15% PRO-EDUCACION Y ASISTENCIA SOCIAL ( APLICADOS AL REGISTRO CIVIL )		-4,354.00	0.00	0.00	0.00	-4,354.00
21173021024004	15% PRO-CAMINOS ( APLICADOS AL REGISTRO CIVIL )		-4,354.00	0.00	0.00	0.00	-4,354.00
21173021024005	15% PRO-TURISMO ( APLICADOS AL REGISTRO CIVIL )		-4,354.00	0.00	0.00	0.00	-4,354.00
21173021024006	15% PRO-RECUPERACION ECOLOGICA ( APLICADOS AL REGISTRO CIVIL )		-4,354.00	0.00	0.00	0.00	-4,354.00
21173021025	EJERCICIO 2018 (NVA. ADMINISTRACION)		151,418.00	0.00	0.00	0.00	151,418.00
21173021025001	15% CONTRIBUCION ESTATAL SIMPUUESTOS Y DERECHOS MPALES		85,352.00	0.00	0.00	0.00	85,352.00
21173021025002	10% ADMINISTRACION DE REGISTRO CIVIL		9,706.00	0.00	0.00	0.00	9,706.00
21173021025003	15% PRO-EDUCACION Y ASISTENCIA SOCIAL ( APLICADOS AL REGISTRO CIVIL )		14,090.00	0.00	0.00	0.00	14,090.00
21173021025004	15% PRO-CAMINOS ( APLICADOS AL REGISTRO CIVIL )		14,090.00	0.00	0.00	0.00	14,090.00
21173021025005	15% PRO-TURISMO ( APLICADOS AL REGISTRO CIVIL )		14,090.00	0.00	0.00	0.00	14,090.00
21173021025006	15% PRO-RECUPERACION ECOLOGICA ( APLICADOS AL REGISTRO CIVIL )		14,090.00	0.00	0.00	0.00	14,090.00
21173041	INGRESOS PROPIOS		0.00	2,150.00	1,668,467.32	1,668,467.32	1,668,467.32
21173041026	EJERCICIO 2019		0.00	2,150.00	1,668,467.32	1,668,467.32	1,668,467.32
21173041026001	15% CONTRIBUCION ESTATAL SIMPUUESTOS Y DERECHOS MPALES		0.00	2,150.00	1,336,843.52	1,336,843.52	1,336,843.52
21173041026002	10% ADMINISTRACION DE REGISTRO CIVIL		0.00	0.00	71,411.40	71,411.40	71,411.40
21173041026003	15% PRO-EDUCACION Y ASISTENCIA SOCIAL ( APLICADOS AL REGISTRO CIVIL )		0.00	0.00	65,053.10	65,053.10	65,053.10
21173041026004	15% PRO-CAMINOS ( APLICADOS AL REGISTRO CIVIL )		0.00	0.00	65,053.10	65,053.10	65,053.10
21173041026005	15% PRO-TURISMO ( APLICADOS AL REGISTRO CIVIL )		0.00	0.00	65,053.10	65,053.10	65,053.10
21173041026006	15% PRO-RECUPERACION ECOLOGICA ( APLICADOS AL REGISTRO CIVIL )		0.00	0.00	65,053.10	65,053.10	65,053.10
21177	IMPUESTO SOBRE NOMINAS Y OTROS QUE PERVIENEN DE UNA RELACION LABORAL POR PAGAR A CP		73,036,360.68	3,597,803.60	37,315,175.57	106,753,732.66	106,753,732.66
21177021	GASTO CORRIENTE		63,245,218.87	1,990,179.98	32,839,444.89	94,094,483.76	94,094,483.76
21177021020	EJERCICIO 2015		3,525,192.88	0.00	0.00	3,525,192.88	3,525,192.88
21177021020001	IMPUESTO SOBRE SUELDOS Y SALARIOS (SIR) miércoles 25 marzo 2020		3,525,192.88	0.00	0.00	3,525,192.88	3,525,192.88

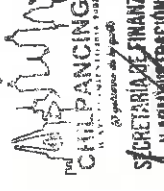
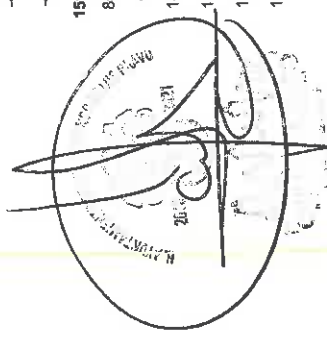



H. AYUNTAMIENTO MUNICIPAL DE CHILPANCINGO, GRO.  
SECRETARIA DE FINANZAS Y ADMINISTRACION  
CONSOLIDADO



BALANZA DE COMPROBACIÓN DEL 1 DE ENERO AL 31 DE DICIEMBRE DEL 2019

C U E N T A	C O N C E P T O	SALDOS INICIALES		MOVIMIENTOS		SALDOS ACUMULADOS	
		AL 1 DE ENERO DE 2019		ENERO - DICIEMBRE 2019		AL 31 DE DICIEMBRE DE 2019	
		DEBE	HABER	DEBE	HABER	DEBE	HABER
21177021021	EJERCICIO 2016		17,100,015.31	0.00	0.00	17,100,015.31	
21177021021001	IMPUESTO SOBRE SUELDOS Y SALARIOS (ISR)		17,100,015.31	0.00	0.00	17,100,015.31	
21177021022	EJERCICIO 2017		15,566,711.81	0.00	0.00	15,566,711.81	
21177021022001	IMPUESTO SOBRE SUELDOS Y SALARIOS (ISR)		15,566,711.81	0.00	0.00	15,566,711.81	
21177021023	PERIODO OCT-DIC 2017		4,180,256.35	0.00	0.00	4,180,256.35	
21177021023001	IMPUESTO SOBRE SUELDOS Y SALARIOS (ISR)		4,180,256.35	0.00	0.00	4,180,256.35	
21177021024	EJERCICIO 2018		15,779,756.80	0.00	0.00	15,779,756.80	
21177021024001	IMPUESTO SOBRE SUELDOS Y SALARIOS (ISR)		15,779,756.80	0.00	0.00	15,779,756.80	
21177021025	EJERCICIO 2018 (NUEVA ADMINISTRACION)		7,093,285.72	0.00	21,837.40	7,115,123.12	
21177021025001	IMPUESTO SOBRE SUELDOS Y SALARIOS (ISR)		7,093,285.72	0.00	21,837.40	7,115,123.12	
21177021026	EJERCICIO 2019		0.00	1,990,179.98	0.00	1,990,179.98	
21177021026001	IMPUESTO SOBRE SUELDOS Y SALARIOS (ISR)		0.00	1,990,179.98	0.00	1,990,179.98	
21177021026002	FONDO DE APORTACIONES PARA LA INFRAESTRUCTURA SOCIAL DE LOS MUNICIPIOS		85,633.60	0.00	0.00	85,633.60	
21177022021	EJERCICIO 2016		31,010.71	0.00	0.00	31,010.71	
21177022021001	5 AL MILLAR DE INSP Y VERIFIC DE OBRA		22,236.07	0.00	0.00	22,236.07	
21177022021002	2 AL MILLAR DE INSP Y VERIFIC DE OBRA		8,774.64	0.00	0.00	8,774.64	
21177022022	EJERCICIO 2017		54,622.89	0.00	0.00	54,622.89	
21177022022001	5 AL MILLAR DE INSP Y VERIFIC DE OBRA		44,195.81	0.00	0.00	44,195.81	
21177022022002	2 AL MILLAR DE INSP Y VERIFIC DE OBRA		10,427.08	0.00	0.00	10,427.08	
21177023020	FONDO DE APORT P/IFORT DE LOS MPIO		9,688,810.67	1,607,623.62	4,475,730.68	12,556,917.73	
2117702302001	EJERCICIO 2015		484,475.07	0.00	0.00	484,475.07	
2117702302001001	IMPUESTOS SOBRE SUELDOS Y SALARIOS (ISR)		484,475.07	0.00	0.00	484,475.07	
21177023021	EJERCICIO 2016		3,959,040.69	0.00	0.00	3,959,040.69	
21177023021001	IMPUESTOS SOBRE SUELDOS Y SALARIOS (ISR)		3,959,040.69	0.00	0.00	3,959,040.69	
21177023022	EJERCICIO 2017		3,124,552.22	0.00	0.00	3,124,552.22	
21177023022001	IMPUESTOS SOBRE SUELDOS Y SALARIOS (ISR)		3,124,552.22	0.00	0.00	3,124,552.22	
21177023024	EJERCICIO 2018		1,490,947.36	0.00	38,314.77	1,529,262.13	
21177023024001	IMPUESTOS SOBRE SUELDOS Y SALARIOS (ISR)		1,490,947.36	0.00	38,314.77	1,529,262.13	
21177023025	EJERCICIO 2018 (NUEVA ADMINISTRACION)		629,795.33	0.00	0.00	629,795.33	
21177023025001	IMPUESTO SOBRE SUELDOS Y SALARIOS (ISR)		629,795.33	0.00	0.00	629,795.33	
21177023026	EJERCICIO 2019		0.00	1,048,778.89	4,437,415.91	3,388,637.02	
21177023026001	IMPUESTO SOBRE SUELDOS Y SALARIOS (ISR)		0.00	1,048,778.89	4,437,415.91	3,388,637.02	

21

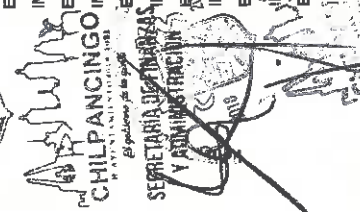



H. AYUNTAMIENTO MUNICIPAL DE CHILPANCINGO, GRO.

SECRETARIA DE FINANZAS Y ADMINISTRACION

CONSOLIDADO



BALANZA DE COMPROBACIÓN DEL 1 DE ENERO AL 31 DE DICIEMBRE DEL 2019

C U E N T A	C O N C E P T O	SALDOS INICIALES		MOVIMIENTOS		SALDOS ACUMULADOS	
		AL 1 DE ENERO DE 2019		ENERO - DICIEMBRE 2019		AL 31 DE DICIEMBRE DE 2019	
		DEBE	HABER	DEBE	HABER	DEBE	HABER
21177 027	FORTALECE		16,697.55	0.00	0.00	0.00	16,697.55
21177 027 021	EJERCICIO 2016		16,697.55	0.00	0.00	0.00	16,697.55
21177 027 021 001	5 AL MILLAR DE IINSP Y VERIF DE OBRA		11,926.82	0.00	0.00	0.00	11,926.82
21177 027 021 002	2 AL MILLAR DE IINSP Y VERIF DE OBRA		4,770.73	0.00	0.00	0.00	4,770.73
21179	OTRAS RETENCIONES Y CONTRIBUCIONES POR PAGAR A CP		14,190,529.11	3,607,665.77	6,184,863.35	16,767,726.69	
21179 001	GASTO CORRIENTE		4,566.06	792.57	0.00	0.00	3,773.49
21179 001 002	EJERCICIO 2009		4,566.06	792.57	0.00	0.00	3,773.49
21179 001 002 002	FAV		1,020.00	0.00	0.00	0.00	1,020.00
21179 001 002 003	PRESTAMO ISSSPEG		792.57	792.57	0.00	0.00	0.00
21179 001 002 004	PRESTAMOS FAV		2,753.49	0.00	0.00	0.00	2,753.49
21179 003	FONDO DE APORT PIFORT DE LOS MPIO		5,354.83	0.00	0.00	0.00	5,354.83
21179 003 004	EJERCICIO 2011		5,354.83	0.00	0.00	0.00	5,354.83
21179 003 004 004	PRESTAMOS FAV		5,354.83	0.00	0.00	0.00	5,354.83
21179 021	GASTO CORRIENTE		5,354.83	0.00	0.00	0.00	5,354.83
21179 021 020	PERIODO 2015-2018		12,132,123.14	2,447,497.49	4,771,981.88	14,456,607.53	
21179 021 020 002	FAV		949,362.00	141,075.07	0.00	0.00	808,286.93
21179 021 020 003	PRESTAMOS ISSSPEG		58,300.00	0.00	0.00	0.00	58,300.00
21179 021 020 004	PRESTAMOS FAV		199,674.25	0.00	0.00	0.00	199,674.25
21179 021 020 006	FONDO PARA PREVISION SOCIAL		224,245.18	0.00	0.00	0.00	224,245.18
21179 021 020 007	FONACOT		22,270.00	0.00	0.00	0.00	22,270.00
21179 021 020 008	CUOTAS VOLUNTARIAS ( FUNCIONARIOS )		69,130.52	0.00	0.00	0.00	69,130.52
21179 021 020 011	CUOTAS SINDICALES		80,033.84	0.00	0.00	0.00	80,033.84
21179 021 021	EJERCICIO 2016		295,708.21	141,075.07	0.00	0.00	154,633.14
21179 021 021 002	FAV		4,268,961.76	0.00	0.00	0.00	4,268,961.76
21179 021 021 003	PRESTAMOS ISSSPEG		243,220.00	0.00	0.00	0.00	243,220.00
21179 021 021 004	PRESTAMOS FAV		712,803.33	0.00	0.00	0.00	712,803.33
21179 021 021 006	FONDO PARA PREVISION SOCIAL		1,090,763.70	0.00	0.00	0.00	1,090,763.70
21179 021 021 007	FONACOT		78,530.00	0.00	0.00	0.00	78,530.00
21179 021 021 008	CUOTAS VOLUNTARIAS ( FUNCIONARIOS )		854,413.12	0.00	0.00	0.00	854,413.12
21179 021 021 011	CUOTAS SINDICALES		389,678.60	0.00	0.00	0.00	389,678.60
21179 021 022	EJERCICIO 2017		889,553.01	0.00	0.00	0.00	889,553.01
21179 021 022 002	FAV		3,830,924.76	0.00	0.00	0.00	3,830,924.76
			181,700.00	0.00	0.00	0.00	181,700.00

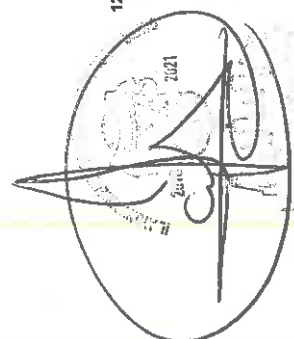

H. Ayuntamiento Chilpancingo, Gro. Secretario de Finanzas y Administración



H. AYUNTAMIENTO MUNICIPAL DE CHILPANCINGO, GRO.  
SECRETARIA DE FINANZAS Y ADMINISTRACION  
CONSOLIDADO



BALANZA DE COMPROBACION DEL 1 DE ENERO AL 31 DE DICIEMBRE DEL 2019

C U E N T A	C O N C E P T O	SALDOS INICIALES		MOVIMIENTOS		SALDOS ACUMULADOS	
		AL 1 DE ENERO DE 2019		ENERO - DICIEMBRE 2019		AL 31 DE DICIEMBRE DE 2019	
		DEBE	HABER	DEBE	HABER	DEBE	HABER
21179 021 022 003	PRESTAMOS ISSSPEG		613,471.73		0.00		613,471.73
21179 021 022 004	PRESTAMOS FAV		805,889.36		0.00		805,889.36
21179 021 022 006	FONDO PARA PREVISION SOCIAL		112,060.00		0.00		112,060.00
21179 021 022 007	FONACOT		427,971.32		0.00		427,971.32
21179 021 022 008	CUOTAS VOLUNTARIAS 1.5%		354,565.78		0.00		354,565.78
21179 021 022 011	CUOTAS SINDICALES		1,109,167.84		0.00		1,109,167.84
21179 021 022 013	REINT. DES.		5,085.58		0.00		5,085.58
21179 021 022 014	DIAS DEST. NAT.		221,013.35		0.00		221,013.35
21179 021 023	EJERCICIO 2017 (OCT-DIC)		398,378.27		0.00		398,378.27
21179 021 023 002	FAV		27,760.00		0.00		27,760.00
21179 021 023 003	PRESTAMOS ISSSPEG		23,628.33		0.00		23,628.33
21179 021 023 004	PRESTAMOS FAV		164,695.15		0.00		164,695.15
21179 021 023 006	FONDO PARA PREVISION SOCIAL		6,940.00		0.00		6,940.00
21179 021 023 007	FONACOT		9,301.98		0.00		9,301.98
21179 021 023 008	CUOTAS VOLUNTARIAS 1.5%		18,525.35		0.00		18,525.35
21179 021 023 011	CUOTAS SINDICALES		147,527.46		0.00		147,527.46
21179 021 024	EJERCICIO 2018		1,878,051.50	134,191.44	0.00		1,743,860.06
21179 021 024 002	FAV		66,202.18		0.00		66,202.18
21179 021 024 003	PRESTAMOS ISSSPEG		177,904.97		0.00		177,904.97
21179 021 024 004	PRESTAMOS FAV		383,008.72		0.00		383,008.72
21179 021 024 006	FONDO PARA PREVISION SOCIAL		12,850.00		0.00		12,850.00
21179 021 024 007	FONACOT		11,120.58		0.00		11,120.58
21179 021 024 011	CUOTAS SINDICALES		1,193,018.79		0.00		1,193,018.79
21179 021 024 013	REINT. DES.		33,946.26		0.00		33,946.26
21179 021 025	EJERCICIO 2018 NVA. ADMINISTRACION		806,444.85	235,888.93	792.57		571,338.49
21179 021 025 002	FAV		82,000.00		0.00		82,000.00
21179 021 025 003	PRESTAMOS ISSSPEG		3,962.85		0.00		3,962.85
21179 021 025 004	PRESTAMOS FAV		113,246.34		0.00		113,246.34
21179 021 025 006	FONDO PARA PREVISION SOCIAL		41,000.00		0.00		41,000.00
21179 021 025 011	CUOTAS SINDICALES		566,235.66		0.00		566,235.66
21179 021 026	EJERCICIO 2018		0.00	1,936,332.05	4,771,189.31		2,834,857.26
21179 021 026 002	FAV		0.00		0.00		0.00
21179 021 026 003	PRESTAMOS ISSSPEG		0.00		0.00		0.00
							1,585.14
							325,420.00
							1,585.14

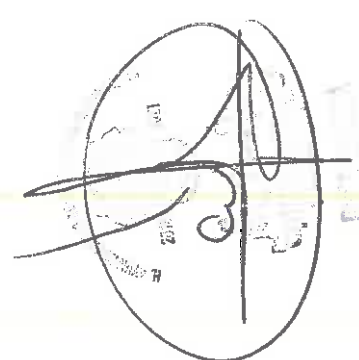

H. Ayuntamiento Municipal Chilpancingo, Gro.  
Comprobatario de  
Cuentas Internas Municipales





H. AYUNTAMIENTO MUNICIPAL DE CHILPANCINGO, GRO.  
SECRETARIA DE FINANZAS Y ADMINISTRACION  
CONSOLIDADO



BALANZA DE COMPROBACIÓN DEL 1 DE ENERO AL 31 DE DICIEMBRE DEL 2019

C U E N T A	C O N C E P T O	SALDOS INICIALES		MOVIMIENTOS		SALDOS ACUMULADOS	
		AL 1 DE ENERO DE 2019		ENERO - DICIEMBRE 2019		AL 31 DE DICIEMBRE DE 2019	
		DEBE	HABER	DEBE	HABER	DEBE	HABER
21179021026004	PRESTAMOS FAV	0.00	0.00	0.00	0.00	451,033.37	451,033.37
21179021026006	FONDO PARA PREVISION SOCIAL	0.00	0.00	0.00	0.00	162,710.00	162,710.00
21179021026011	CUOTAS SINDICALES	0.00	0.00	736,367.55	2,630,476.30	1,894,108.75	1,894,108.75
21179021026015	PRESTAMOS JVM APPRECIA FINANCIERA	0.00	0.00	1,189,964.50	1,199,964.50	0.00	0.00
21179023	FONDO DE APORT P/FORT DE LOS MIPIOS	2,048,485.08	0.00	1,159,375.71	1,412,881.47	2,301,980.84	2,301,980.84
21179023020	EJERCICIO 2015-2018	39,625.86	0.00	0.00	0.00	39,625.86	39,625.86
2117902302002	FONDO DE APORTACION VOLUNTARIA	1,880.00	0.00	0.00	0.00	1,880.00	1,880.00
2117902302003	PRESTAMOS A CORTO Y MEDIANO PLAZO	10,380.99	0.00	0.00	0.00	10,380.99	10,380.99
2117902302004	PRESTAMOS FAV	12,327.70	0.00	0.00	0.00	12,327.70	12,327.70
2117902302006	FONDO PARA PREVISION SOCIAL	940.00	0.00	0.00	0.00	940.00	940.00
2117902302010	CUOTAS SINDICALES	14,097.17	0.00	0.00	0.00	14,097.17	14,097.17
21179023021	EJERCICIO 2016	1,032,634.27	0.00	0.00	0.00	1,032,634.27	1,032,634.27
21179023021002	FONDO DE APORTACION VOLUNTARIA	12,240.00	0.00	0.00	0.00	12,240.00	12,240.00
21179023021003	PRESTAMOS A CORTO Y MEDIANO PLAZO	41,139.65	0.00	0.00	0.00	41,139.65	41,139.65
21179023021004	PRESTAMOS FAV	73,059.37	0.00	0.00	0.00	73,059.37	73,059.37
21179023021006	FONDO PARA PREVISION SOCIAL	470.00	0.00	0.00	0.00	470.00	470.00
21179023021007	FONACOT	794,157.74	0.00	0.00	0.00	794,157.74	794,157.74
21179023021010	CUOTAS SINDICALES	69,747.51	0.00	0.00	0.00	69,747.51	69,747.51
21179023021011	J. MERCANTIL	257.38	0.00	0.00	0.00	257.38	257.38
21179023021013	CUOTAS VOLUNTARIA 1.5%	41,562.62	0.00	0.00	0.00	41,562.62	41,562.62
21179023022	EJERCICIO 2017	725,907.72	0.00	0.00	0.00	725,907.72	725,907.72
21179023022001	DESCUENTOS VARIOS	19,803.60	0.00	0.00	0.00	19,803.60	19,803.60
21179023022002	FONDO DE APORTACION VOLUNTARIA	10,680.00	0.00	0.00	0.00	10,680.00	10,680.00
21179023022003	PRESTAMOS ISSSPEG	115,184.51	0.00	0.00	0.00	115,184.51	115,184.51
21179023022004	PRESTAMOS FAV	75,634.30	0.00	0.00	0.00	75,634.30	75,634.30
21179023022006	FONDO DE PREVISION SOCIAL	7,740.00	0.00	0.00	0.00	7,740.00	7,740.00
21179023022007	FONACOT	311,425.21	0.00	0.00	0.00	311,425.21	311,425.21
21179023022010	CUOTAS SINDICALES	149,132.35	0.00	0.00	0.00	149,132.35	149,132.35
21179023022012	PRESTAMO CAJA XIV	1,090.68	0.00	0.00	0.00	1,090.68	1,090.68
21179023022013	CUOTAS VOLUNTARIA 1.5%	35,217.07	0.00	0.00	0.00	35,217.07	35,217.07
21179023023	EJERCICIO 2017 (OCT-DIC)	17,367.88	0.00	0.00	0.00	17,367.88	17,367.88
21179023023007	FONACOT	3,663.56	0.00	0.00	0.00	3,663.56	3,663.56

*[Handwritten signature]*



SECRETARIA DE FINANZAS Y ADMINISTRACION



M. Ayuntamiento Municipal Constitucional Chilpancingo, Gro.  
CONTRALORIA INTERMEDIA





H. AYUNTAMIENTO MUNICIPAL DE CHILPANCINGO, GRO.  
SECRETARIA DE FINANZAS Y ADMINISTRACION  
CONSOLIDADO



BALANZA DE COMPROBACIÓN DEL 1 DE ENERO AL 31 DE DICIEMBRE DEL 2019

C U E N T A	C O N C E P T O	SALDOS INICIALES		MOVIMIENTOS		SALDOS ACUMULADOS	
		AL 1 DE ENERO DE 2019		ENERO - DICIEMBRE 2019		AL 31 DE DICIEMBRE DE 2019	
		DEBE	HABER	DEBE	HABER	DEBE	HABER
21179023023010	CUOTAS SINDICALES		11,832.39		0.00	0.00	11,832.39
21179023023013	CUOTAS VOLUNTARIA 1.5%		1,871.93		0.00	0.00	1,871.93
21179023024	EJERCICIO 2018		121,525.59	11,898.38			109,627.21
21179023024002	FONDO DE APORTACION VOLUNTARIA		6,287.08	0.00	0.00	0.00	6,287.08
21179023024003	PRESTAMOS ISSSPEG		5,648.76	0.00	0.00	0.00	5,648.76
21179023024004	PRESTAMOS FAV		8,926.26	0.00	0.00	0.00	8,926.26
21179023024006	FONDO DE PREVISION SOCIAL		20,114.66	0.00	0.00	0.00	20,114.66
21179023024007	FONACOT		2,930.99	0.00	0.00	0.00	2,930.99
21179023024010	CUOTAS SINDICALES		77,617.84	11,898.38	0.00	0.00	65,719.46
21179023025	EJERCICIO 2018-2021 (NUEVA ADMINISTRACION)		111,423.76	72,171.01	0.00	0.00	39,252.75
21179023025002	FONDO DE APORTACION VOLUNTARIA		5,160.00	3,060.00	0.00	0.00	2,100.00
21179023025004	PRESTAMOS FAV		13,767.45	8,260.47	0.00	0.00	5,506.98
21179023025006	FONDO DE PREVISION SOCIAL		3,090.00	1,530.00	0.00	0.00	1,560.00
21179023025008	CUOTAS SINDICALES		89,406.31	59,320.54	0.00	0.00	30,085.77
21179023026	EJERCICIO 2019		0.00	1,075,306.32	1,412,881.47		337,575.15
21179023026002	FONDO DE APORTACION VOLUNTARIA		0.00	0.00	0.00	0.00	24,540.00
21179023026004	PRESTAMOS FAV		0.00	0.00	0.00	0.00	67,340.06
21179023026006	FONDO DE PREVISION SOCIAL		0.00	0.00	0.00	0.00	12,270.00
21179023026008	CUOTAS SINDICALES		0.00	261,003.75	494,428.84		233,425.09
21179023026011	PRESTAMOS JMV APRECIA FINANCIERA		0.00	814,302.57	814,302.57		0.00
2119	OTRAS CUENTAS POR PAGAR A CORTO PLAZO		178,619,850.21	105,407,307.76	189,010,716.42		256,213,258.87
21191	FONDOS ROTATORIOS POR COMPROBAR A CP		233,702.80	1,124,019.39	5,685,675.11		4,795,358.52
21191021	GASTO CORRIENTE		88,687.78	915,527.75	947,389.32		120,549.35
21191021020	PERIODO 2015-2018		0.05	0.00	0.00		0.05
2119102102009	MIGUEL ALEJANDRO AÑORVE BAUTISTA		0.05	0.00	0.00		0.05
21191021023	PERIODO OCT-DIC 2017		5,635.87	636.16	0.00		4,999.71
21191021023019	JUICIO MERCANTIL		5,635.87	636.16	0.00		4,999.71
21191021024	EJERCICIO 2018		74,695.02	5,725.44	0.00		68,969.58
21191021024019	JUICIO MERCANTIL		29,119.68	5,725.44	0.00		23,394.24
21191021024031	CRISTINA MORALES NICOLAS		18,137.92	0.00	0.00		18,137.92
21191021024046	DEPOSITOS BANCARIOS POR REGISTRAR		27,437.42	0.00	0.00		27,437.42
21191021025	EJERCICIO 2018 IVA. ADMINISTRACION 2018		8,356.84	1,908.48	0.00		6,448.36

AYUNTAMIENTO MUNICIPAL DE CHILPANCINGO DE LOS BAÑOS  
SECRETARIA DE FINANZAS  
MIGUEL ALEJANDRO AÑORVE BAUTISTA  
MIGUEL ALEJANDRO AÑORVE BAUTISTA  
MIGUEL ALEJANDRO AÑORVE BAUTISTA



H. AYUNTAMIENTO MUNICIPAL DE CHILPANCINGO, GRO.

SECRETARIA DE FINANZAS Y ADMINISTRACION

CONSOLIDADO



BALANZA DE COMPROBACIÓN DEL 1 DE ENERO AL 31 DE DICIEMBRE DEL 2019

C U E N T A	C O N C E P T O	SALDOS INICIALES		M O V I M I E N T O S		SALDOS ACUMULADOS	
		AL 1 DE ENERO DE 2019		ENERO - DICIEMBRE 2019		AL 31 DE DICIEMBRE DE 2019	
		DEBE	HABER	DEBE	HABER	DEBE	HABER
2021	JUICIO MERCANTIL	8,356.84		1,908.48			6,448.36
21191021026019	EJERCICIO 2019	0.00		907,257.67		947,389.32	40,131.65
21191021026001	LUIS CORTÉS ZARAGOZA	0.00		169,528.80		195,411.82	25,883.02
21191021026002	WILIBALDO VALENTE PASTOR	0.00		50,677.91		50,677.91	0.00
21191021026003	DIANA AIDA BELLO FLORES	0.00		95,118.43		95,118.43	0.00
21191021026004	FIDEL NAVA CRUZ	0.00		119,380.17		119,380.17	0.00
21191021026005	GURI CARMEN ZULLUAGA HUERTA	0.00		44,000.00		44,000.00	0.00
21191021026006	ANTONIO OROZCO GUADARRAMA	0.00		1,260.00		1,260.00	0.00
21191021026007	CELFA JUAREZ FIERRO	0.00		32,260.47		32,260.47	0.00
21191021026008	VIANEY CASTORENA TENORIO	0.00		128,705.29		128,705.29	0.00
21191021026009	FRANCISCO JAVIER VERGARA MARTINEZ	0.00		5,000.00		5,000.00	0.00
21191021026010	MARITZA IMEJDA CUENCA VELEZ	0.00		23,173.70		23,173.70	0.00
21191021026011	MA. ELENA JAIMES SILVA	0.00		5,423.23		5,423.23	0.00
21191021026012	JUICIO MERCANTIL	0.00		4,829.09		4,829.09	0.00
21191021026019	MA DEL ROCIO VEGA BAUTISTA	0.00		3,335.07		17,583.70	14,248.63
21191021026020	JESUS RAUL SALGADO CARACHURE	0.00		1,735.00		1,735.00	0.00
21191021026021	ADOLFO CALDERON NAVA	0.00		8,000.00		8,000.00	0.00
21191021026022	MARIA DE LOURDES ORTIZ BASURTO	0.00		8,000.00		8,000.00	0.00
21191021026023	NETZAHUALCOYOTL EUGENIO RENTERIA	0.00		37,975.00		37,975.00	0.00
21191021026024	LUCIANO VILLANUEVA LLUVIAS	0.00		4,988.00		4,988.00	0.00
21191021026025	ADRIANA JOSAHANDY H. LUZ TELLEZ	0.00		7,216.28		7,216.28	0.00
21191021026026	MARBELLA OLIVEROS MUÑOZ	0.00		25,076.37		25,076.37	0.00
21191021026027	MA ELENA GUTIERREZ CRUZ	0.00		1,300.00		1,300.00	0.00
21191021026028	ROBERTO ADRIAN ALARCON LEON	0.00		16,551.97		16,551.97	0.00
21191021026029	CÁRLOTA MOJICA MORGAN	0.00		5,440.00		5,440.00	0.00
21191021026030	VICTOR MANUEL ORTEGA CORONA	0.00		43,001.91		43,001.91	0.00
21191021026031		0.00		2,051.50		2,051.50	0.00

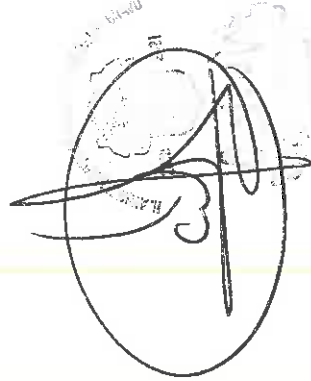

Contraloría Interior Municipal



H. AYUNTAMIENTO MUNICIPAL DE CHILPANCINGO, GRO.  
SECRETARIA DE FINANZAS Y ADMINISTRACION  
CONSOLIDADO



BALANZA DE COMPROBACION DEL 1 DE ENERO AL 31 DE DICIEMBRE DEL 2019

C U E N T A	C O N C E P T O	SALDOS INICIALES		MOVIMIENTOS		SALDOS ACUMULADOS	
		AL 1 DE ENERO DE 2019		ENERO - DICIEMBRE 2019		AL 31 DE DICIEMBRE DE 2019	
		DEBE	HABER	DEBE	HABER	DEBE	HABER
21191021026032	FABRICO BAUTISTA ROMERO	0.00	0.00	2,836.50	2,836.50	2,836.50	0.00
21191021026033	GABRIEL MORLET MACIEL	0.00	0.00	10,154.44	10,154.44	10,154.44	0.00
21191021026034	BULMARO TAFIA SOBERANIS	0.00	0.00	31,294.44	31,294.44	31,294.44	0.00
21191021026035	ZOBEC IBARRA LOPEZ	0.00	0.00	5,691.56	5,691.56	5,691.56	0.00
21191021026036	MA. GUADALUPE ZAMORA MEMIJE	0.00	0.00	3,279.99	3,279.99	3,279.99	0.00
21191021026037	JAVIER BELLO TORRES	0.00	0.00	3,142.68	3,142.68	3,142.68	0.00
21191021026038	ALBA NELI NAVARRETE LORENZO	0.00	0.00	600.00	600.00	600.00	0.00
21191021026039	EFREN ENCARNACION NAVA	0.00	0.00	2,878.22	2,878.22	2,878.22	0.00
21191021026040	MIGUEL ANGEL GUERRERO GARCIA	0.00	0.00	1,157.65	1,157.65	1,157.65	0.00
21191021026041	RAUL RENDON MUÑOZ	0.00	0.00	2,194.00	2,194.00	2,194.00	0.00
21191023	FONDO DE APORT P/FORT DE LOS MPIO	130,955.09	4,595,874.39	66,080.24	4,595,874.39	66,080.24	4,660,749.24
21191023022	EJERCICIO 2017	120,346.28	0.00	0.00	0.00	0.00	120,346.28
21191023022001	ESTEBAN ESPINOSA MONTOYA	1,025.60	0.00	0.00	0.00	0.00	1,025.60
21191023022002	DIFERENCIAS EN CHEQUES	2.98	0.00	0.00	0.00	0.00	2.98
21191023022004	VICTOR HUGO NAVA LOPEZ	119,317.70	0.00	0.00	0.00	0.00	119,317.70
21191023023	EJERCICIO 2017 (OCT-DIC)	2,335.46	0.00	0.00	0.00	0.00	2,335.46
21191023023007	JUICIO MERCANTIL	2,335.46	0.00	0.00	0.00	0.00	2,335.46
21191023024	EJERCICIO 2018	8,273.35	0.00	0.00	0.00	0.00	8,273.35
21191023024001	DIFERENCIAS EN CHEQUES	22.16	0.00	0.00	0.00	0.00	22.16
21191023024006	JUICIO MERCANTIL	3,503.19	0.00	0.00	0.00	0.00	3,503.19
21191023024016	FABIOLA CHACON VARGAS	4,748.00	0.00	0.00	0.00	0.00	4,748.00
21191023026	EJERCICIO 2019	0.00	0.00	66,080.24	4,595,874.39	66,080.24	4,528,794.16
21191023026001	EDGAR CAIN PEREZ BURCIAGA	0.00	0.00	7,000.00	7,000.00	7,000.00	0.00
21191023026002	JUICIO MERCANTIL	0.00	0.00	680.24	9,341.84	680.24	8,661.60
21191023026003	LAZARO ADALBERTO FIGUEROA RAMIREZ	0.00	0.00	14,175.00	14,175.00	14,175.00	0.00
21191023026004	FABRICO BAUTISTA ROMERO	0.00	0.00	26,225.00	26,225.00	26,225.00	0.00
21191023026005	MANSTER EMMANUEL DAMIAN BAUTISTA	0.00	0.00	18,000.00	18,000.00	18,000.00	0.00
21191023026006	SANTANDER CTA 65506534043 FORTAMUN (SEG PUB) 2018	0.00	0.00	0.00	0.00	0.00	0.00
21191023026007	BANAMEX CTA: 7013 8224682 (FORTAMUN)	0.00	0.00	0.00	4,457,187.66	4,457,187.66	4,457,187.66
21191025	FORTASEG FEDERAL	0.00	0.00	0.00	0.00	0.00	63,944.89
21191025026	EJERCICIO 2019	0.00	0.00	142,411.40	142,411.40	142,411.40	0.00
		0.00	0.00	142,411.40	142,411.40	142,411.40	0.00

H. AYUNTAMIENTO MUNICIPAL DE CHILPANCINGO, GRO.  
SECRETARIA DE FINANZAS Y ADMINISTRACION  
CONSOLIDADO

2019  
2021

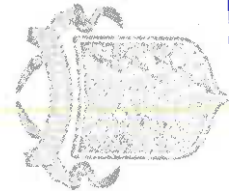

H. Ayuntamiento Municipal Chilpancingo  
CONTRALORIA INTERNA



H. AYUNTAMIENTO MUNICIPAL DE CHILPANCINGO, GRO.  
SECRETARIA DE FINANZAS Y ADMINISTRACION  
CONSOLIDADO



BALANZA DE COMPROBACION DEL 1 DE ENERO AL 31 DE DICIEMBRE DEL 2019

C U E N T A	C O N C E P T O	SALDOS INICIALES		MOVIMIENTOS		SALDOS ACUMULADOS	
		AL 1 DE ENERO DE 2019		ENERO - DICIEMBRE 2019		AL 31 DE DICIEMBRE DE 2019	
		DEBE	HABER	DEBE	HABER	DEBE	HABER
21191025026001	JULIA PABLO AHUEJOTE		0.00	27,000.00	27,000.00	0.00	0.00
21191025026002	RUTH SARAI NAVARRO CANO		0.00	27,000.00	27,000.00	0.00	0.00
21191025026003	NAYELI MINERVA MORENO GALEANA		0.00	27,000.00	27,000.00	0.00	0.00
21191025026004	JUAN MOISES OROPEZA		0.00	27,000.00	27,000.00	0.00	0.00
21191025026005	LIZZETH ALMAZAN ROSAS		0.00	27,000.00	27,000.00	0.00	0.00
21191025026006	GUSTAVO CERVANTES CHAVELA		0.00	7,411.40	7,411.40	0.00	0.00
21191033	PROGRAMA FAFEF		14,059.93	0.00	0.00	0.00	14,059.93
21191033022	EJERCICIO 2017		14,059.93	0.00	0.00	0.00	14,059.93
21191033022001	PROG. FINANCIAM FINANCIAM FINANC P/INVERSION RAMO 23		14,059.93	0.00	0.00	0.00	14,059.93
21199	OTRAS CUENTAS POR PAGAR A CP		172,376,147.41	104,283,288.37	183,325,041.31	0.00	261,417,900.35
21199021	GASTO CORRIENTE		143,063,303.81	61,195,929.60	130,962,819.71	0.00	212,830,193.92
2119902101	EJERCICIO 2016		2,788,256.33	0.00	0.00	0.00	2,788,256.33
2119902101079	ALFREDO CARBAJAL CERON		104,800.00	0.00	0.00	0.00	104,800.00
2119902101086	OFELIA CHAVEZ RODRIGUEZ		104,800.00	0.00	0.00	0.00	104,800.00
2119902101105	MARIA DEL SOCORRO NANDI PASCASIO		104,800.00	0.00	0.00	0.00	104,800.00
2119902101101	MANUEL ALEJANDRO OCAMPO REYES		78,600.00	0.00	0.00	0.00	78,600.00
2119902101106	PROGRAMA DE FORTALECE		982,677.07	0.00	0.00	0.00	982,677.07
2119902101107	PROG FINANCIAM FINANCIAM FINANC P/INVERSION RAMO 23		1,374,630.96	0.00	0.00	0.00	1,374,630.96
2119902101108	PROGRAM DE FAFEF (RELLENO SANITARIO)		37,948.30	0.00	0.00	0.00	37,948.30
21199021022	EJERCICIO 2017		107,333,219.22	0.00	0.00	0.00	107,333,219.22
21199021022001	FORTAMUN (SEGURIDAD PUBLICA)		10,781,024.18	0.00	0.00	0.00	10,781,024.18
21199021022004	F.A.I.S.M. RAMO XXXIII		88,246,162.04	0.00	0.00	0.00	88,246,162.04
21199021022034	MIGUEL CASTRO CASTRO		78,600.00	0.00	0.00	0.00	78,600.00
21199021022047	LIDUBINA ROMERO ALVARADO		78,600.00	0.00	0.00	0.00	78,600.00
21199021022102	FORTASEG		5,898,833.00	0.00	0.00	0.00	5,898,833.00
21199021022110	PROGRAMA DE FORTALECE		2,250,000.00	0.00	0.00	0.00	2,250,000.00
21199021023004	EJERCICIO 2017 (OCT-DIC NVA ADMON)		2,417,994.74	0.00	0.00	0.00	2,417,994.74
21199021023004	FORTAMUN (SEGURIDAD PUBLICA)		2,417,994.74	0.00	0.00	0.00	2,417,994.74
21199021024	EJERCICIO 2018		20,872,545.89	0.00	0.00	0.00	20,872,545.89
21199021024001	FORTAMUN (SEGURIDAD PUBLICA)		5,080,945.91	0.00	0.00	0.00	5,080,945.91
21199021024002	F.A.I.S.M. RAMO XXXIII		12,991,948.80	0.00	0.00	0.00	12,991,948.80
21199021024005	DEPOSITOS POR REGISTRAR		79,817.97	0.00	0.00	0.00	79,817.97
21199021024010	CRUZ ALBERTO MUÑOZ ESPIRITU		78,600.00	0.00	0.00	0.00	78,600.00

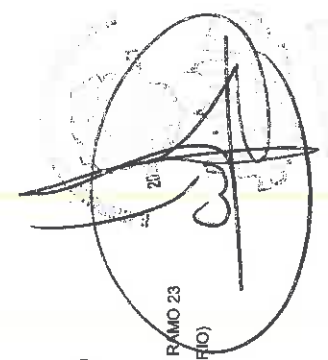



H. AYUNTAMIENTO MUNICIPAL DE CHILPANCINGO, GRO.

SECRETARIA DE FINANZAS Y ADMINISTRACION

CONSOLIDADO



BALANZA DE COMPROBACION DEL 1 DE ENERO AL 31 DE DICIEMBRE DEL 2019

C U E N T A	C O N C E P T O	SALDOS INICIALES		MOVIMIENTOS		SALDOS ACUMULADOS	
		AL 1 DE ENERO DE 2019		ENERO - DICIEMBRE 2019		AL 31 DE DICIEMBRE DE 2019	
		DEBE	HABER	DEBE	HABER	DEBE	HABER
21199021024066	PROGRAMA DE RAMO 23		37.12		0.00	0.00	37.12
21199021024069	SECRETARIA DE FINANZAS Y ADMINISTRACION DEL GOBIERNO DEL ESTADO (2% SOBRE REMUNERACIONES PERSONALES)		2,641,150.65		0.00	0.00	2,641,150.65
21199021024100	PROGRAMA DE FORTALECE		45.24		0.00	0.00	45.24
21199021025025	EJERCICIO 2018 (NVA. ADMINISTRACION)		9,651,287.83		9,616,995.83	0.00	34,292.00
21199021025022	SEGURIDAD PUBLICA		9,365,488.83		9,365,488.83	0.00	0.00
21199021025004	DEPOSITOS BANCARIOS POR IDENTIFICAR		48,799.00		14,507.00	0.00	34,292.00
21199021025007	FORTASEC		237,000.00		237,000.00	0.00	0.00
21199021025026	EJERCICIO 2019		0.00		51,578,933.77	130,962,819.71	79,383,885.94
21199021025001	ALAN GARCIA AGUILAR		0.00		5,000.00	0.00	0.00
21199021025002	SECRETARIA DE FINANZAS Y ADMINISTRACION DEL GOBIERNO DEL ESTADO (2% SOBRE REMUNERACIONES PERSONALES)		0.00		2,137,880.00	0.00	0.00
21199021026004	DEPOSITOS BANCARIOS POR IDENTIFICAR		0.00		0.00	0.00	0.00
21199021026006	INGRESOS PROPIO (PRESTAMO)		0.00		0.00	0.00	0.00
21199021026007	SEGURIDAD PUBLICA (PRESTAMO)		0.00		3,891,417.09	22,675,418.96	18,784,001.87
21199021026008	KAREN ARELI ORTEGA SALGADO		0.00		39,203,473.07	76,036,590.40	36,835,117.33
21199021026009	PROGRAMA PRODDER (PRESTAMO)		0.00		1,333,843.09	2,317,686.18	983,843.09
21199021026010	FAEISM (PRESTAMO)		0.00		159,520.90	159,520.90	0.00
21199021026011	ROMERO OCAÑO PORTILLO		0.00		0.00	5,184,693.36	5,184,693.36
21199021026012	PATRONATO DE LA FERIA DE SAN MATEO, NAVIDAD Y AÑO NUEVO		0.00		20,000.00	20,000.00	0.00
21199021026013	JORGE ALBERTO MARTINEZ DURAN		0.00		4,350,000.00	4,350,000.00	0.00
21199021026014	ALEJANDRO MOJICA NAVA		0.00		80,371.68	80,371.68	0.00
21199021026015	OBRA PUBLICA "FAISM" (PRESTAMOS)		0.00		119,046.58	119,046.58	0.00
21199021026016	JUANA CHABELAS VIDAL		0.00		0.00	17,488,164.85	17,488,164.85
21199021026017	LEOPOLDINA ALCOECER PASTOR		0.00		0.00	6,000.00	6,000.00
21199021026018	GRACIELA VARGAS GARCIA		0.00		6,786.36	33,831.78	27,065.42
21199021026019	VIARIOS		0.00		25,000.00	100,000.00	75,000.00
21199021026020	FONDO DE APORTE PINFRAEST SOC MPAL		0.00		246,615.00	246,615.00	0.00
21199022022	EJERCICIO 2017		19,000,000.00		0.00	0.00	19,000,000.00
21199022022012	COMISION DE AGUA POTABLE, ALCANTARILLADO Y SANEAMIENTO DEL ESTADO DE GUERRERO		19,000,000.00		0.00	0.00	19,000,000.00
21199023021	FONDO DE APORTE PIFORT DE LOS MPIO		7,127,707.13		4,159,828.74	8,333,662.38	11,301,540.77
21199023021021	EJERCICIO 2016		847,212.55		0.00	0.00	847,212.55

Handwritten signature and stamp

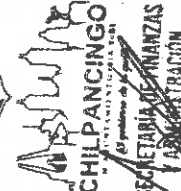
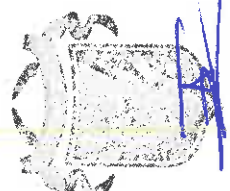





H. AYUNTAMIENTO MUNICIPAL DE CHILPANCINGO, GRO.

SECRETARIA DE FINANZAS Y ADMINISTRACION

CONSOLIDADO



BALANZA DE COMPROBACIÓN DEL 1 DE ENERO AL 31 DE DICIEMBRE DEL 2019

C U E N T A	C O N C E P T O	SALDOS INICIALES		MOVIMIENTOS		SALDOS ACUMULADOS	
		AL 1 DE ENERO DE 2019		ENERO - DICIEMBRE 2019		AL 31 DE DICIEMBRE DE 2019	
		DEBE	HABER	DEBE	HABER	DEBE	HABER
2119023021002	PRESTAMOS A SINDICATO INDEPENDIENTE		1,250.00	0.00	0.00	0.00	1,250.00
2119023021011	PROGRAMA FE FORTALECE		845,962.55	0.00	0.00	0.00	845,962.55
2119023022	EJERCICIO 2017		5,850,000.00	0.00	0.00	0.00	5,850,000.00
2119023022003	F.A.I.S.M. RAMO XXXIII		5,850,000.00	0.00	0.00	0.00	5,850,000.00
2119023024	EJERCICIO 2018		427,939.35	0.00	0.00	0.00	427,939.35
2119023024005	SECRETARIA DE FINANZAS Y ADMON DEL GOB EDO (2% SOBRE REMUNERACIONES PERSONALES)		264,789.96	0.00	0.00	0.00	264,789.96
2119023024007	PROGRAMA F'SM-DF		163,149.39	0.00	0.00	0.00	163,149.39
2119023025	EJERCICIO 2018-2021		2,555.23	0.00	0.00	0.00	2,555.23
2119023025001	PENSION ALIMENTICIA		2,555.23	0.00	0.00	0.00	2,555.23
2119023026	EJERCICIO 2019		0.00	4,159,828.74	4,159,828.74	8,333,662.38	4,173,833.64
2119023026001	PENSION ALIMENTICIA		0.00	2,537,053.14	2,537,053.14	2,552,804.58	15,751.44
2119023026002	COMISION NACIONAL DEL AGUA		0.00	1,603,490.00	1,603,490.00	1,603,490.00	0.00
2119023026003	COMISIONES BANCARIAS		0.00	1,285.60	1,285.60	1,285.60	0.00
2119023026004	INGRESOS PROPIOS		0.00	0.00	0.00	0.00	0.00
2119023026005	DEPOSITOS EN EFECTIVO POR IDENTIFICAR		0.00	12,000.00	12,000.00	12,000.00	0.00
2119023026006	HUMBERTO ALARCON ALARCON		0.00	6,000.00	6,000.00	6,000.00	0.00
2119025	FORTASEG		3,185,136.47	5,574,994.42	5,574,994.42	5,245,370.70	0.00
2119025022	EJERCICIO 2017		2,855,512.72	0.00	0.00	0.00	2,855,512.72
2119025022001	FORTAMUN (SEG. PUB.)		2,855,512.72	0.00	0.00	0.00	2,855,512.72
2119025024	SECRETARIA DE FINANZAS Y ADMINISTRACION		329,623.66	329,623.83	329,623.83	0.17	0.00
2119025024001	GASTO CORRIENTE		329,623.66	329,623.83	329,623.83	0.17	0.00
2119025025	EJERCICIO 2018 (NVA ADMON 2018-2021)		0.09	0.06	0.06	0.00	0.03
2119025025002	DIFERENCIA EN PAGO DE CHEQUES		0.09	0.06	0.06	0.00	0.03
2119025026	EJERCICIO 2019 (NVA ADMON 2018-2021)		0.00	5,245,370.53	5,245,370.53	5,245,370.53	0.00
2119025026001	JUAN ANTONIO TORREBLANCA HINOJOSA		0.00	5,245,370.53	5,245,370.53	5,245,370.53	0.00
2119032	PRODDER-CCNAGUA		0.00	3,353,639.20	3,353,639.20	3,353,639.20	0.00
2119032026	EJERCICIO 2019		0.00	3,353,639.20	3,353,639.20	3,353,639.20	0.00
2119032026001	PARTICIPACIONES FEDERALES PRODDER-CONAGUA		0.00	1,906,947.00	1,906,947.00	1,906,947.00	0.00
2119032026002	PRÓG. GASTO CORRIENTE		0.00	686,692.20	686,692.20	686,692.20	0.00
2119032026003	CAPACH		0.00	760,000.00	760,000.00	760,000.00	0.00
2119040	FAEISM		0.00	0.00	0.00	275,215.63	275,215.63
2119040026	EJERCICIO 2019		0.00	0.00	0.00	275,215.63	275,215.63

  
 SECRETARIA DE FINANZAS Y ADMINISTRACION  
 2019



H. Ayuntamiento Municipal Consolidado  
 Chilpancingo Gro  
 CONTRALORIA INTERNA MUNICIPAL



H. AYUNTAMIENTO MUNICIPAL DE CHILPANCINGO, GRO.  
SECRETARIA DE FINANZAS Y ADMINISTRACION  
CONSOLIDADO



BALANZA DE COMPROBACIÓN DEL 1 DE ENERO AL 31 DE DICIEMBRE DEL 2019

C U E N T A	C O N C E P T O	SALDOS INICIALES		MOVIMIENTOS		SALDOS ACUMULADOS	
		AL 1 DE ENERO DE 2019		ENERO - DICIEMBRE 2019		AL 31 DE DICIEMBRE DE 2019	
		DEBE	HABER	DEBE	HABER	DEBE	HABER
2119040026001	INGRESOS PROPIOS (PRESTAMOS)		0.00	0.00	275,215.63		275,215.63
2119041	INGRESOS PROPIOS		0.00	29,988,896.41	35,154,333.69		5,155,437.28
2119041026	EJERCICIO 2019		0.00	29,988,896.41	35,154,333.69		5,155,437.28
2119041026001	SEGURIDAD PUBLICA (Prestamos)		0.00	1,647,277.18	1,647,277.18		0.00
2119041026002	DEPOSITOS PENDIENTES DE IDENTIFICAR		0.00	2,257,207.18	3,098,635.38		841,428.20
2119041026003	DEPOSITOS PENDIENTES DE IDENTIFICAR CATASTRO		0.00	24,608,421.13	24,608,421.13		0.00
2119041026004	SERVICIOS PATRIMONIALES JVM SA		0.00	1,485,990.92	5,800,000.00		4,314,009.08
212	DOCUMENTOS POR PAGAR A CORTO PLAZO	28,000,000.00		28,500,000.00	10,040,000.00		8,540,000.00
2123	DOCUMENTOS A PAGAR A CORTO PLAZO A INSTITUCIONES FINANCIERAS	28,000,000.00		28,500,000.00	10,040,000.00		8,540,000.00
21231	CRÉDITOS BANCARIOS	28,000,000.00		29,500,000.00	10,040,000.00		8,540,000.00
21231021	GASTO CORRIENTE	28,000,000.00		29,500,000.00	10,040,000.00		8,540,000.00
21231021025	EJERCICIO 2018 NUEVA ADMINSTRACION	28,000,000.00		28,000,000.00	0.00		0.00
21231021025001	SEFINA	28,000,000.00		28,000,000.00	0.00		0.00
21231021026	EJERCICIO 2019		0.00	1,500,000.00	10,040,000.00		8,540,000.00
21231021026001	SEFINA		0.00	1,500,000.00	10,040,000.00		8,540,000.00
3	HACIENDA PÚBLICA/ PATRIMONIO		53,997,184.75	103,160,518.39	96,571,038.37		-60,586,664.77
31	HACIENDA PÚBLICA/PATRIMONIO CONTRIBUIDO		124,780,493.71		0.00		124,780,493.71
311	APORTACIONES		124,780,493.71		0.00		124,780,493.71
3111	APORTACIONES		124,780,493.71		0.00		124,780,493.71
31116	BIENES P/FOMENTO Y DESARROLLO AGROPECUARIO		124,780,493.71		0.00		124,780,493.71
31116023	FONDO DE APORT P/FORT DE LOS MPIO		22,005,607.59		0.00		22,005,607.59
31116023020	ADMON 2009-2012		22,005,607.59		0.00		22,005,607.59
31116023020001	PATRIMONIO DE LAS ADMINISTRACIONES ANTERIORES		22,005,607.59		0.00		22,005,607.59
31119	PATRIMONIO ADMINISTRACIONES ANTERIORES		102,774,886.12		0.00		102,774,886.12
31119021	GASTO CORRIENTE		102,774,886.12		0.00		102,774,886.12
31119021020	ADMON 2009-2012		102,774,886.12		0.00		102,774,886.12
31119021020001	PATRIMONIO ADMINISTRACIONES ANTERIORES		102,774,886.12		0.00		102,774,886.12
32	HACIENDA PÚBLICA /PATRIMONIO GENERADO		-178,777,678.46	103,160,518.39	96,571,038.37		-185,367,158.46
321	RESULTADOS DEL EJERCICIO (AHORRO/ DESAHORRO)		-31,475,269.22	33,481,438.50	64,956,707.72		0.00
3211	RESULTADOS DEL EJERCICIO (AHORRO/ DESAHORRO)		-31,475,269.22	33,481,438.50	64,956,707.72		0.00
32111	RESULTADOS DEL EJERCICIO (AHORRO/ DESAHORRO)		-31,475,269.22	33,481,438.50	64,956,707.72		0.00

2018  
2019







H. AYUNTAMIENTO MUNICIPAL DE CHILPANCINGO, GRO.  
SECRETARIA DE FINANZAS Y ADMINISTRACION  
CONSOLIDADO



BALANZA DE COMPROBACION DEL 1 DE ENERO AL 31 DE DICIEMBRE DEL 2019

C U E N T A	C O N C E P T O	SALDOS INICIALES		M O V I M I E N T O S		SALDOS ACUMULADOS	
		AL 1 DE ENERO DE 2019		ENERO - DICIEMBRE 2019		AL 31 DE DICIEMBRE DE 2019	
		DEBE	HABER	DEBE	HABER	DEBE	HABER
3 2 2 1 1 0 0 3 0 1 0 0 0 1	REA 2017 (ADMON OCT-DIC)		4,669.16		25.01	18.80	4,662.95
3 2 2 1 1 0 0 3 0 1 1	EJERCICIO 2018		0.00		12,738.05	9,482,196.47	9,469,458.42
3 2 2 1 1 0 0 3 0 1 1 0 0 1	EJERCICIO 2018		0.00		12,738.05	9,482,196.47	9,469,458.42
3 2 2 1 1 0 0 8	FERTILIZANTE I.E.D		0.00		0.00	66,654.00	66,654.00
3 2 2 1 1 0 0 8 0 1 1	EJERCICIO 2018		0.00		0.00	66,654.00	66,654.00
3 2 2 1 1 0 0 8 0 1 1 0 0 1	REA EJERCICIO 2018		0.00		0.00	66,654.00	66,654.00
3 2 2 1 1 0 2 1	GASTO CORRIENTE		-221,179,262.98		65,560,736.01	90,010.00	66,654.00
3 2 2 1 1 0 2 1 0 0 8	EJERCICIO 2015		-38,034,646.07		0.00	0.00	-38,034,646.07
3 2 2 1 1 0 2 1 0 0 8 0 0 1	REA 2015		-38,034,646.07		0.00	0.00	-38,034,646.07
3 2 2 1 1 0 2 1 0 0 9	EJERCICIO 2016		-92,818,236.10		0.00	0.00	-92,818,236.10
3 2 2 1 1 0 2 1 0 0 9 0 0 1	REA 2016		-92,818,236.10		0.00	0.00	-92,818,236.10
3 2 2 1 1 0 2 1 0 1 0	EJERCICIO 2017		-90,326,380.81		0.00	0.00	-90,326,380.81
3 2 2 1 1 0 2 1 0 1 0 0 0 2	APORTACION DEL PROGRAMA FORTALECIMIENTO FINANCIERO		1,999,708.00		0.00	0.00	1,999,708.00
3 2 2 1 1 0 2 1 0 1 0 0 3	REA ADMON OCT-DIC 2017 GASTO CORRIENTE		-92,326,088.81		0.00	0.00	-92,326,088.81
3 2 2 1 1 0 2 1 0 1 1	EJERCICIO 2018		0.00		65,560,736.01	90,010.00	-65,470,726.01
3 2 2 1 1 0 2 1 0 1 1 0 0 1	GASTO CORRIENTE		0.00		65,560,736.01	90,010.00	-65,470,726.01
3 2 2 1 1 0 2 5	FORTASEG		0.00		0.00	5,370,212.00	5,370,212.00
3 2 2 1 1 0 2 5 0 1 1	EJERCICIO 2018		0.00		0.00	5,370,212.00	5,370,212.00
3 2 2 1 1 0 2 5 0 1 1 0 0 0 1	REA 2018 (ADMON OCT-DIC)		0.00		0.00	5,370,212.00	5,370,212.00
3 2 2 1 1 0 2 7	FORTALECE		0.00		45.24	1,394.58	1,339.34
3 2 2 1 1 0 2 7 0 1 1	EJERCICIO 2018		0.00		45.24	1,394.58	1,339.34
3 2 2 1 1 0 2 7 0 1 1 0 0 1	REA 2018		0.00		45.24	1,394.58	1,339.34
3 2 2 1 1 0 2 8	ESPACIOS PUBLICOS		0.00		0.00	562.94	562.94
3 2 2 1 1 0 2 8 0 1 1	EJERCICIO 2018		0.00		0.00	562.94	562.94
3 2 2 1 1 0 2 8 0 1 1 0 0 0 1	REA EJERCICIO 2018		0.00		0.00	562.94	562.94
3 2 2 1 1 0 3 0	RAMO 23		143.73		2,200,000.00	2,200,471.18	614.91
3 2 2 1 1 0 3 0 0 1 0	EJERCICIO 2017		143.73		0.00	0.00	143.73
3 2 2 1 1 0 3 0 0 1 0 0 1	REA 2017 (ADMON OCT-DIC)		143.73		0.00	0.00	143.73
3 2 2 1 1 0 3 0 0 2 5	EJERCICIO 2018		0.00		2,200,000.00	2,200,471.18	471.18
3 2 2 1 1 0 3 0 0 2 5 0 0 1	REA 2018 (ADMON ENE-SEPT) PAVIMENTACION DE LA CALLE PROLONGACION CUAUHTEMOC DE LA COLONIA CETIS		0.00		1,200,000.00	1,200,000.00	0.00

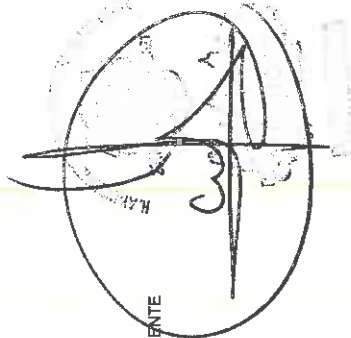



H. AYUNTAMIENTO MUNICIPAL DE CHILPANCINGO, GRO.  
SECRETARIA DE FINANZAS Y ADMINISTRACION  
CONSOLIDADO



BALANZA DE COMPROBACION DEL 1 DE ENERO AL 31 DE DICIEMBRE DEL 2019

C U E N T A	C O N C E P T O	SALDOS INICIALES		MOVIMIENTOS		SALDOS ACUMULADOS	
		AL 1 DE ENERO DE 2019		ENERO - DICIEMBRE 2019		AL 31 DE DICIEMBRE DE 2019	
		DEBE	HABER	DEBE	HABER	DEBE	HABER
3 2 2 1 1 0 3 0 0 2 5 0 0 2	REA 2018 (ADMN ENE-SEPT) "PAVIMENTACION DE LA CALLE EUCALIPTO DE LA COLONIA EL AMATE"	0.00	0.00	1,000,000.00	1,000,000.00	0.00	0.00
3 2 2 1 1 0 3 0 0 2 5 0 0 3	REA					471.18	471.18
3 2 2 1 1 0 3 2	PRODDER					728,225.23	728,225.23
3 2 2 1 1 0 3 2 0 1 1	EJERCICIO 2018					728,225.23	728,225.23
3 2 2 1 1 0 3 2 0 1 1 0 0 1	REA 2018					728,225.23	728,225.23
3 2 2 1 1 0 3 3	FAFEF					0.18	0.18
3 2 2 1 1 0 3 3 0 1 0	EJERCICIO 2017					0.00	0.04
3 2 2 1 1 0 3 3 0 1 0 0 1	REA 2017 (ADMN OCT-DIC)					0.00	0.04
3 2 2 1 1 0 3 3 0 1 1	EJERCICIO 2018					0.00	0.18
3 2 2 1 1 0 3 3 0 1 1 0 0 1	REA 2018					0.00	0.18
3 2 2 2	RESULTADO DE EJERCICIOS ANTERIORES					0.00	0.00
3 2 2 2 2	RESULTADO DE EJERCICIOS ANTERIORES					1,029,771.58	0.00
3 2 2 2 2 0 0 2	FONDO DE APORT P INFRA SOC MPAL					1,029,771.58	0.00
3 2 2 2 2 0 0 2 0 0 7	EJERCICIO 2014					0.00	0.00
3 2 2 2 2 0 0 2 0 0 1	REA 2014					0.00	0.00
3 2 2 2 2 0 0 2 0 0 2	EJERCICIO 2015					0.00	0.00
3 2 2 2 2 0 0 2 0 0 2 0 0 1	REA 2015					0.00	0.00
3 2 2 2 2 0 0 2 0 0 2 0 0 2	FONDO DE APORT P INFRA SOC MPAL					1,029,771.58	0.00
3 2 2 2 2 0 0 2 0 0 2 0 0 3	EJERCICIO 2016					0.00	0.00
3 2 2 2 2 0 0 2 0 0 2 0 0 1	REA 2016					0.00	0.00
3 2 2 2 2 0 0 2 0 0 2 0 0 3	EJERCICIO 2017					0.00	0.00
3 2 2 2 2 0 0 2 0 0 2 0 0 1	REA 2017 (ADMN ENE-OCT 2017)					1,029,771.58	0.00
3 2 2 3	RESULTADO DE EJERCICIOS ANTERIORES					0.00	0.00
3 2 2 3 3	RESULTADO DE EJERCICIOS ANTERIORES					0.00	0.00
3 2 2 3 3 0 2 3	FONDO DE APORT P IFORT DE LOS MIPOS					0.00	0.00
3 2 2 3 3 0 2 3 0 2 0	EJERCICIO 2015					0.00	0.00
3 2 2 3 3 0 2 3 0 2 0 0 1	REA 2015					0.00	0.00
3 2 2 3 3 0 2 3 0 2 1	EJERCICIO 2016					0.00	0.00
3 2 2 3 3 0 2 3 0 2 1 0 0 1	REA 2016					0.00	0.00

*[Handwritten signature and stamp]*

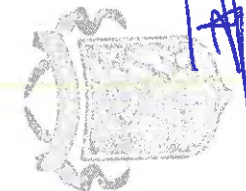







H. AYUNTAMIENTO MUNICIPAL DE CHILPANCINGO, GRO.  
SECRETARIA DE FINANZAS Y ADMINISTRACION  
CONSOLIDADO



BALANZA DE COMPROBACIÓN DEL 1 DE ENERO AL 31 DE DICIEMBRE DEL 2019

C U E N T A	C O N C E P T O	SALDOS INICIALES		MOVIMIENTOS		SALDOS ACUMULADOS	
		AL 1 DE ENERO DE 2019		ENERO - DICIEMBRE 2019		AL 31 DE DICIEMBRE DE 2019	
		DEBE	HABER	DEBE	HABER	DEBE	HABER
	EJERCICIO 2017		1,120,638.26	0.00	0.00	0.00	1,120,638.26
3224403202	REA 2017 (ADMON ENE-OCT 2017)		1,120,638.26	0.00	0.00	0.00	1,120,638.26
41	INGRESOS Y CITROS BENEFICIOS		0.00	58,814,198.07	932,936,447.31		873,122,249.24
411	INGRESOS DE GESTIÓN		0.00	59,814,197.65	167,654,908.17		107,840,711.52
4111	IMPUESTOS		0.00	59,798,841.65	130,732,607.75		70,933,766.10
41111	IMPUESTOS SOBRE LOS INGRESOS		0.00	0.00	5,550.00		5,550.00
411111	IMPUESTOS SOBRE LOS INGRESOS		0.00	0.00	5,550.00		5,550.00
411111001	IMPUESTOS		0.00	0.00	5,550.00		5,550.00
41111001001	IMPUESTOS SOBRE LOS INGRESOS		0.00	0.00	5,550.00		5,550.00
41111001001001	IMPUESTOS SOBRE DIVERSIONES Y ESPECTACULOS PUBLICOS		0.00	0.00	5,550.00		5,550.00
41111001001001001	BAILLES PARTICULARES, NO ESPECULATIVOS CUANDO SE DESARROLLEN EN ALGUN ESPACIO PUBLICO		0.00	0.00	5,550.00		5,550.00
4112	IMPUESTOS SOBRE EL PATRIMONIO		0.00	0.00	72,982,144.93		72,982,144.93
41121	IMPUESTOS SOBRE EL PATRIMONIO		0.00	0.00	72,982,144.93		72,982,144.93
41121001	IMPUESTOS		0.00	0.00	72,982,144.93		72,982,144.93
41121001002	IMPUESTOS SOBRE EL PATRIMONIO		0.00	0.00	72,982,144.93		72,982,144.93
41121001002001	PREDIOS URBANOS Y SUB-URBANOS BALDIOS		0.00	0.00	6,360,161.00		6,360,161.00
41121001002001001	URBANOS BALDIOS		0.00	0.00	6,334,895.00		6,334,895.00
41121001002001002	SUB-URBANOS BALDIOS		0.00	0.00	25,266.00		25,266.00
41121001002003	PREDIOS RUSTICOS BALDIOS		0.00	0.00	444,925.00		444,925.00
41121001002003001	PREDIOS URBANOS, SUB-URBANOS Y RUSTICOS EDIFICADOS		0.00	0.00	444,925.00		444,925.00
41121001002004001	URBANOS EDIF. DESTINADOS A CASA HABITACION		0.00	0.00	49,146,556.37		49,146,556.37
41121001002004002	SUB-URBANOS EDIFICADOS DESTINADOS A CASA HABITACION		0.00	0.00	47,929,983.37		47,929,983.37
41121001002004003	RUSTICOS EDIFICADOS DESTINADOS A CASA HABITACION		0.00	0.00	21,023.00		21,023.00
41121001002006001	PREDIOS EDIFICADOS PROPIEDAD DE MEXICANA DESTINADO EXCLUSIVAMENTE A CASA HABITACION		0.00	0.00	1,195,549.00		1,195,549.00
41121001002006002	PENSIONADOS Y JUBILADOS		0.00	0.00	3,288,931.00		3,288,931.00
41121001002008001	INSEN		0.00	0.00	1,514,276.00		1,514,276.00
41121001002008002	PERSONAS DE CAPACIDADES DIFERENTES		0.00	0.00	1,273,286.00		1,273,286.00
41121001002008003	MADRES Y/O PADRES SOLTEROS JEFES DE FAMILIA		0.00	0.00	25,537.00		25,537.00
41121001002008004			0.00	0.00	475,832.00		475,832.00

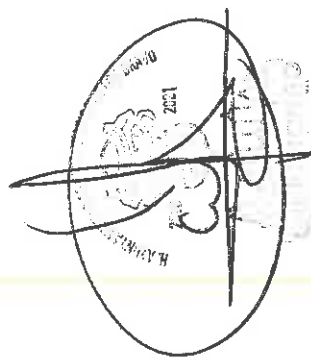

H. Ayuntamiento Municipal de Chilpancingo, Gro.  
Secretaría de Finanzas y Administración



H. AYUNTAMIENTO MUNICIPAL DE CHILPANCINGO, GRO.

SECRETARIA DE FINANZAS Y ADMINISTRACION

CONSOLIDADO



BALANZA DE COMPROBACION DEL 1 DE ENERO AL 31 DE DICIEMBRE DEL 2019

C U E N T A	C O N C E P T O	SALDOS INICIALES		MOVIMIENTOS		SALDOS ACUMULADOS	
		AL 1 DE ENERO DE 2019		ENERO - DICIEMBRE 2019		AL 31 DE DICIEMBRE DE 2019	
		DEBE	HABER	DEBE	HABER	DEBE	HABER
41121001002010	IMPUESTOS SOBRE ADQUISICIONES DE INMUEBLES	0.00	0.00	0.00	0.00	13,741,572.56	13,741,572.56
4112100100201001	SOBRE ADQUISICION DE INMUEBLES	0.00	0.00	0.00	0.00	13,741,572.56	13,741,572.56
4117	ACCESORIOS DE IMPUESTOS	0.00	0.00	0.00	0.00	28,198,492.43	28,198,492.43
41171	ACCESORIOS DE IMPUESTOS	0.00	0.00	0.00	0.00	28,198,492.43	28,198,492.43
41171001	IMPUESTOS	0.00	0.00	0.00	0.00	28,198,492.43	28,198,492.43
41171001007	ACCESORIOS	0.00	0.00	0.00	0.00	28,198,492.43	28,198,492.43
41171001007001	RECARGOS	0.00	0.00	0.00	0.00	28,198,492.43	28,198,492.43
41171001007001001	PREDIAL	0.00	0.00	0.00	0.00	24,054,045.13	24,054,045.13
41171001007002	RECARGOS	0.00	0.00	0.00	0.00	24,054,045.13	24,054,045.13
41171001007002001	RECARGOS (ADQUISICION DE INMUEBLES)	0.00	0.00	0.00	0.00	371,970.00	371,970.00
41171001007003	ACTUALIZACIONES	0.00	0.00	0.00	0.00	371,970.00	371,970.00
41171001007003001	PREDIAL	0.00	0.00	0.00	0.00	3,772,477.30	3,772,477.30
4118	OTROS IMPUESTOS	0.00	0.00	0.00	0.00	3,772,477.30	3,772,477.30
41191	OTROS IMPUESTOS	0.00	0.00	59,798,841.65	59,798,841.65	29,546,420.39	30,252,421.26
41191001	IMPUESTOS	0.00	0.00	59,798,841.65	59,798,841.65	29,546,420.39	30,252,421.26
41191001008	OTROS IMPUESTOS	0.00	0.00	59,798,841.65	59,798,841.65	29,546,420.39	30,252,421.26
41191001008001	APLICADOS A IMPTO PREDIAL Y DERECHOS POR SERVICIOS CATASTRALES	0.00	0.00	59,798,841.65	59,798,841.65	22,254,480.39	37,544,361.26
41191001008001001	15% PRO-EDUCACION Y ASISTENCIA SOCIAL	0.00	0.00	59,798,841.65	59,798,841.65	21,618,372.39	38,179,469.26
41191001008001002	15% PRO-CAMINOS	0.00	0.00	0.00	0.00	10,787,618.59	10,787,618.59
41191001008001003	DESCUENTOS DE IMPUESTO PREDIAL DE NATURALIDAD/DEUDORA	0.00	0.00	0.00	0.00	10,787,618.59	10,787,618.59
41191001008002	APLICADOS A DERECHOS POR SERV DE TRANSIT	0.00	0.00	59,798,841.65	59,798,841.65	44,135.21	59,798,841.65
41191001008002001	15% PRO-EDUCACION Y ASISTENCIA SOCIAL	0.00	0.00	0.00	0.00	635,108.00	635,108.00
41191001008002002	15% PRO-RECUPERACION EQUILIBRIO ECOLOGICO Y FORESTAL	0.00	0.00	0.00	0.00	319,569.00	319,569.00
41191001009	OTROS IMPUESTOS	0.00	0.00	0.00	0.00	315,539.00	315,539.00
41191001009001	REZAGOS	0.00	0.00	0.00	0.00	7,291,940.00	7,291,940.00
41191001009001001	PREDIAL	0.00	0.00	0.00	0.00	7,291,940.00	7,291,940.00
414	DERECHOS	0.00	0.00	0.00	0.00	7,291,940.00	7,291,940.00
4141	DERECHOS POR EL USO, GOCE, APROVECHAMIENTO O EXPLOTACION DE BIENES DE DOMINIO PUBLICO	0.00	0.00	15,356.00	15,356.00	31,064,278.51	31,048,922.51
41411	DERECHOS POR EL USO, GOCE, APROVECHAMIENTO O EXPLOTACION DE BIENES DE DOMINIO PUBLICO	0.00	0.00	15,153.00	15,153.00	5,759,867.53	5,744,714.53
41411001	DERECHOS	0.00	0.00	15,153.00	15,153.00	5,759,867.53	5,744,714.53
41411001001	DERECHOS	0.00	0.00	15,153.00	15,153.00	5,759,867.53	5,744,714.53

2019

2021

SECRETARIA DE FINANZAS Y ADMINISTRACION

CHILPANCINGO

2021



H. Ayuntamiento Municipal Constitucional de Chilpancingo, Gro.  
SECRETARIA DE FINANZAS Y ADMINISTRACION



H. AYUNTAMIENTO MUNICIPAL DE CHILPANCINGO, GRO.  
SECRETARIA DE FINANZAS Y ADMINISTRACION

CONSOLIDADO



BALANZA DE COMPROBACION DEL 1 DE ENERO AL 31 DE DICIEMBRE DEL 2019

C U E N T A	C O N C E P T O	SALDOS INICIALES		M O V I M I E N T O S		SALDOS ACUMULADOS	
		AL 1 DE ENERO DE 2019		ENERO - DICIEMBRE 2019		AL 31 DE DICIEMBRE DE 2019	
		DEBE	HABER	DEBE	HABER	DEBE	HABER
41411004001	DERECHOS POR EL USO, GOCE, APROVECHAMIENTO O EXPLOTACION DE BIENES DE DOMINIO PUBLICO	0.00	0.00	15,153.00	5,759,867.53	15,153.00	5,744,714.53
41411004002	LICENCIAS PARA CONSTRUCCION DE EDIFICIOS O CASAS HABITACION, RESTAURACION O REPARACION, URBANIZACION, FRACCIONAMIENTO, LOTIFICACION, RELOTIFICACION, FUSION Y SUBDIVISION LICENCIAS PIEJECUTAR RUPTURAS EN VIA PUBLICA	0.00	0.00	610.00	1,577,604.34	610.00	1,576,994.34
41411004001002001	POR LA EXPEDICION DE LICENCIAS PRIVADAS	0.00	0.00	0.00	17,216.00	0.00	17,216.00
41411004001002002	CONSTRUCCION DE OBRAS PUBLICAS Y URBANIZACION O FRACCIONAMIENTO	0.00	0.00	0.00	1,108,583.00	0.00	1,108,583.00
41411004001002005	POR LA AUTORIZACION DE FUSION DE PREDIOS	0.00	0.00	0.00	55,307.34	0.00	55,307.34
41411004001002006	LOTIFICACION Y RELOTIFICACION DE PREDIOS	0.00	0.00	0.00	42,171.00	0.00	42,171.00
41411004001002007	LICENCIA PIEJECUCION DE OBRAS DENTRO DEL MUNICIPIO MUNICIPAL	0.00	0.00	610.00	327,153.00	610.00	326,543.00
41411004001002009	FUNDA INSCRIPCION DEL DIRECTOR RESPONSABLE DE OBRA	0.00	0.00	0.00	2,800.00	0.00	2,800.00
41411004001002010	LICENCIAS PARA EL ALINEAMIENTO DE EDIFICIOS O CASAS HABITACION Y DE PREDIOS	0.00	0.00	13,593.00	247,783.00	13,593.00	24,374.00
41411004001003001	FOR ALINEAMIENTO EN ZONA URBANA	0.00	0.00	0.00	247,783.00	0.00	24,374.00
41411004001004004	LICENCIAS P/DEMOLICION DE EDIFICIOS O CASAS HABITACION	0.00	0.00	0.00	5,782.00	0.00	5,782.00
41411004001004001	POR EXPED DE LICENCIAS PARA DEMOLICION DE EDIFICIOS O CASAS HABITACION	0.00	0.00	0.00	5,782.00	0.00	5,782.00
41411004001005005	SERVICIOS GENERALES DEL RASTRO MUNICIPAL	0.00	0.00	0.00	12,084.00	0.00	12,084.00
41411004001005001	SACRIFICIO, DESPRENDIDO DE PIEL O GEPALIME, RASURADO, EXTRACCION Y LAVADO DE VISCERAS	0.00	0.00	0.00	12,084.00	0.00	12,084.00
41411004001006006	SERVICIOS GENERALES EN PANTEONES	0.00	0.00	0.00	2,006,612.19	0.00	2,006,612.19
41411004001006001	INHMUMACIONES POR CUERPO	0.00	0.00	0.00	58,828.10	0.00	58,828.10
41411004001006002	EXHUMACIONES POR CUERPO	0.00	0.00	0.00	3,027.09	0.00	3,027.09
41411004001006003001	DESPUES DE TRANSCURRIDO EL TERMINO DE LEY	0.00	0.00	0.00	369.09	0.00	369.09
41411004001006003002	DE CARACTER PREMATURO CUANDO SE HAYA CUMPLIDO LOS REQUISITOS LEGALES NECESARIOS	0.00	0.00	0.00	2,658.00	0.00	2,658.00
41411004001006003	OSARIO, GUARDA Y CUSTODIA ANUALMENTE	0.00	0.00	0.00	1,181,206.00	0.00	1,181,206.00
41411004001006003001	CUOTA ANUAL POR SERVICIO DE MANTENIMIENTO	0.00	0.00	0.00	1,181,206.00	0.00	1,181,206.00
41411004001006004	TRASLADO DE CADAVERES O RESTOS ARIDOS	0.00	0.00	0.00	763,551.00	0.00	763,551.00
41411004001006004001	DENTRO DEL MUNICIPIO	0.00	0.00	0.00	10,016.00	0.00	10,016.00
41411004001006004002	A OTROS MUNICIPIOS DEL ESTADO	0.00	0.00	0.00	2,160.00	0.00	2,160.00

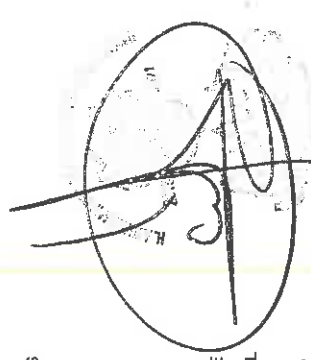

H. Ayuntamiento Municipal Constitucional Chilpancingo, Gro.  
CONTRALORIA MUNICIPAL





H. AYUNTAMIENTO MUNICIPAL DE CHILPANCINGO, GRO.

SECRETARIA DE FINANZAS Y ADMINISTRACION

CONSOLIDADO



BALANZA DE COMPROBACIÓN DEL 1 DE ENERO AL 31 DE DICIEMBRE DEL 2019

C U E N T A	C O N C E P T O	SALDOS INICIALES		MOVIMIENTOS		SALDOS ACUMULADOS	
		AL 1 DE ENERO DE 2019		ENERO - DICIEMBRE 2019		AL 31 DE DICIEMBRE DE 2019	
		DEBE	HABER	DEBE	HABER	DEBE	HABER
41411004001006004003	A OTROS ESTADOS	0.00	0.00	0.00	0.00	216.00	216.00
41411004001006004004	AL EXTRANJERO	0.00	0.00	0.00	0.00	540.00	540.00
41411004001006004005	CERTIFICACION	0.00	0.00	0.00	0.00	16,767.00	16,767.00
41411004001006004006	REESCRITURACION O REGULARIZACION PANTEON NUEVO	0.00	0.00	0.00	0.00	203,519.00	203,519.00
41411004001006004007	CESION DE DERECHOS	0.00	0.00	0.00	0.00	102,725.00	102,725.00
41411004001006004008	REESCRITURACION O REGULARIZACION (JOCIO SUCESORIO PANTEON CENTRAL)	0.00	0.00	0.00	0.00	330,438.00	330,438.00
41411004001006004009	PERPETUIDAD	0.00	0.00	0.00	0.00	49,525.00	49,525.00
41411004001006004010	TEMPORALIDAD	0.00	0.00	0.00	0.00	4,536.00	4,536.00
41411004001006004011	PERPETUIDAD (PANTEON CENTRAL)	0.00	0.00	0.00	0.00	43,109.00	43,109.00
41411004001009	POR EL USO DE LA VIA PUBLICA	0.00	0.00	950.00	950.00	963,155.00	963,155.00
41411004001009001	COMERCIO AMBULANTE	0.00	0.00	950.00	950.00	963,155.00	963,155.00
41411004001010	BAÑOS PUBLICOS	0.00	0.00	0.00	0.00	946,847.00	946,847.00
41411004001010001	BANITARIOS	0.00	0.00	0.00	0.00	946,847.00	946,847.00
4143	DERECHOS POR PRESTACION DE SERVICIOS	0.00	0.00	0.00	0.00	24,078,445.65	24,078,445.65
41431	DERECHOS	0.00	0.00	142.00	142.00	24,078,445.65	24,078,445.65
41431004	DERECHOS POR PRESTACION DE SERVICIOS POR LA EXPEDICION O TRAMITACION DE CONSTANCIAS, CERTIFICACIONES, DUPLICADOS Y COPIAS	0.00	0.00	142.00	142.00	24,078,445.65	24,078,445.65
41431004003	DERECHOS POR PRESTACION DE SERVICIOS POR LA EXPEDICION O TRAMITACION DE CONSTANCIAS, CERTIFICACIONES, DUPLICADOS Y COPIAS	0.00	0.00	142.00	142.00	24,078,445.65	24,078,445.65
41431004003002	DERECHOS POR COPIAS DE PLANOS, AVALUOS Y SERVICIOS CATASTRALES	0.00	0.00	142.00	142.00	187,739.00	187,739.00
41431004003003	CONSTANCIAS	0.00	0.00	142.00	142.00	187,739.00	187,739.00
41431004003003001	CERTIFICACIONES	0.00	0.00	0.00	0.00	6,919,690.10	6,919,690.10
41431004003003002	DUPLICADOS O COPIAS	0.00	0.00	0.00	0.00	2,006,554.47	2,006,554.47
41431004003003003	OTROS SERVICIOS	0.00	0.00	0.00	0.00	3,999,610.08	3,999,610.08
41431004003003004	SERVICIOS DE LIMPIA, ASEO PUBLICO, RECOLECCION, TRASLADO, TRATAMIENTO Y DISPOSICION FINAL DE RESIDUOS A PROPIETARIOS O POSEEDORES DE CASA HABITACION, CONDOMINIOS, DEPARTAMENTOS O SIMILARES	0.00	0.00	0.00	0.00	2,584.54	2,584.54
41431004003004	ESTABLECIMIENTOS COMERCIALES, SERVICIOS DE HOSPEDAJE TEMPORAL, CASAS DE HUESPEDES, APARTAMENTOS AMUEBLADOS, RESTAURANTES, INDUSTRIAS, HOSPITALES,	0.00	0.00	0.00	0.00	910,941.01	910,941.01
41431004003004001	ESTABLECIMIENTOS COMERCIALES, SERVICIOS DE HOSPEDAJE TEMPORAL, CASAS DE HUESPEDES, APARTAMENTOS AMUEBLADOS, RESTAURANTES, INDUSTRIAS, HOSPITALES,	0.00	0.00	0.00	0.00	434,730.00	434,730.00
41431004003004002	ESTABLECIMIENTOS COMERCIALES, SERVICIOS DE HOSPEDAJE TEMPORAL, CASAS DE HUESPEDES, APARTAMENTOS AMUEBLADOS, RESTAURANTES, INDUSTRIAS, HOSPITALES,	0.00	0.00	0.00	0.00	432,230.00	432,230.00
41431004003004002	ESTABLECIMIENTOS COMERCIALES, SERVICIOS DE HOSPEDAJE TEMPORAL, CASAS DE HUESPEDES, APARTAMENTOS AMUEBLADOS, RESTAURANTES, INDUSTRIAS, HOSPITALES,	0.00	0.00	0.00	0.00	2,500.00	2,500.00



H. Ayuntamiento Municipal, Comandante en Jefe de Chilpancingo, Gro. CONTROLADOR INTERNA MUNICIPAL





H. AYUNTAMIENTO MUNICIPAL DE CHILPANCINGO, GRO.  
SECRETARIA DE FINANZAS Y ADMINISTRACION  
CONSOLIDADO



BALANZA DE COMPROBACIÓN DEL 1 DE ENERO AL 31 DE DICIEMBRE DEL 2019

C U E N T A	C O N C E P T O	SALDOS INICIALES		MOVIMIENTOS		SALDOS ACUMULADOS	
		AL 1 DE ENERO DE 2019		ENERO - DICIEMBRE 2019		AL 31 DE DICIEMBRE DE 2019	
		DEBE	HABER	DEBE	HABER	DEBE	HABER
41431004003005	CLINICAS, INSTITUCIONES EDUCATIVAS PARTICULARES Y GIROS DISTINTOS	0.00	0.00	0.00	0.00	2,494,855.00	2,494,855.00
41431004003005001	LICENCIAS PERMISOS DE CIRCULACION Y REPOSICION DE DOCUMENTOS DE TRANSITO	0.00	0.00	0.00	0.00	1,828,780.00	1,828,780.00
41431004003005001001	LICENCIAS P/MANEJAR	0.00	0.00	0.00	0.00	1,085,238.00	1,085,238.00
41431004003005001002	POR EXPEDICION O REPOSICION POR 3 ANIOS	0.00	0.00	0.00	0.00	701,238.00	701,238.00
41431004003005001004	POR EXPEDICION O REPOSICION POR 5 ANIOS	0.00	0.00	0.00	0.00	39,872.00	39,872.00
41431004003005001005	LICENCIA PARA MENORES DE EDAD POR 6 MESES	0.00	0.00	0.00	0.00	1,520.00	1,520.00
41431004003005001007	LICENCIA DE SERVICIO PARTICULAR CON VIGENCIA DE 1 AÑO	0.00	0.00	0.00	0.00	912.00	912.00
41431004003005002	LICENCIAS PARA OPERADORES DE MAQUINAS ESPECIALIZADAS CON VIGENCIA DE UN AÑO	0.00	0.00	0.00	0.00	666,075.00	666,075.00
41431004003005002002	OTROS SERVICIOS	0.00	0.00	0.00	0.00	1,410.00	1,410.00
41431004003005002003	POR REEXPECION DE PERMISO PROVISIONAL POR 30 DIAS PARA CIRCULAR SIN PLACAS	0.00	0.00	0.00	0.00	35,788.00	35,788.00
41431004003005002003	EXPECION DE DUPLICADO DE INFRACCION EXTRAVIADA	0.00	0.00	0.00	0.00	247,494.00	247,494.00
41431004003005002004	POR ARRASTRE DE GRUA DE VIA PUBLICA AL CORRALON	0.00	0.00	0.00	0.00	13,202.00	13,202.00
41431004003005002007	CONSTANCIA DE NO INFRACCION	0.00	0.00	0.00	0.00	9,224.00	9,224.00
41431004003005002008	POR PERMISOS PROVISIONALES TRANSPORTAR CARGA	0.00	0.00	0.00	0.00	232,459.00	232,459.00
41431004003005002009	POR PERMISOS PROVISIONALES TRANSPORTAR CARGA	0.00	0.00	0.00	0.00	126,498.00	126,498.00
41431004003005002010	POR PERMISOS PROVISIONALES TRANSPORTAR CARGA	0.00	0.00	0.00	0.00	9,108,771.20	9,108,771.20
41431004003005002011	POR PERMISOS PROVISIONALES TRANSPORTAR CARGA	0.00	0.00	0.00	0.00	6,154,177.20	6,154,177.20
41431004003005002012	POR PERMISOS PROVISIONALES TRANSPORTAR CARGA	0.00	0.00	0.00	0.00	6,154,177.20	6,154,177.20
41431004003005003	ENAJENACION	0.00	0.00	0.00	0.00	2,920,863.00	2,920,863.00
41431004003005003001	EXPEDICION O REFRENDO INICIAL DE LICENCIAS COMERCIALES EN LOCALES UBICADOS FUERA DEL MERCADO	0.00	0.00	0.00	0.00	2,918,955.00	2,918,955.00
41431004003005003002	POR CUALQUIER MODIFICACION QUE SUFRA LA LICENCIA O EMPADRONAMIENTO DE LOCALES ESTABLECIDOS FUERA DEL MERCADO MUNICIPAL PREVIA AUTORIZACION DEL PRESIDENTE MUNICIPAL	0.00	0.00	0.00	0.00	1,908.00	1,908.00
41431004003005003003	CAMBIO DE DOMICILIO	0.00	0.00	0.00	0.00	33,731.00	33,731.00
41431004003005003004	CAMBIO DE NOMBRE O RAZON SOCIAL	0.00	0.00	0.00	0.00	33,731.00	33,731.00
41431004003005003005	AMPLIACION DE HORARIO ESTABLECIDO A COMERCIOS	0.00	0.00	0.00	0.00	3,096,848.00	3,096,848.00
41431004003005003006	LOCALES FUERA DE MERCADOS	0.00	0.00	0.00	0.00		
41431004003005003007	POR LICENCIAS, PERMISOS O AUTORIZACIONES	0.00	0.00	0.00	0.00		

2019  
2021  
2018



AYUNTAMIENTO DE CHILPANCINGO  
SECRETARIA DE FINANZAS Y ADMINISTRACION  
6.08.08 PM

M. Ayuntamiento Municipal Consolidado Chilpancingo, Gro.  
CONTRALOR MUNICIPAL



H. AYUNTAMIENTO MUNICIPAL DE CHILPANCINGO, GRO.

SECRETARIA DE FINANZAS Y ADMINISTRACION

CONSOLIDADO



BALANZA DE COMPROBACION DEL 1 DE ENERO AL 31 DE DICIEMBRE DEL 2019

C U E N T A	C O N C E P T O	SALDOS INICIALES		MOVIMIENTOS		SALDOS ACUMULADOS	
		AL 1 DE ENERO DE 2019		ENERO - DICIEMBRE 2019		AL 31 DE DICIEMBRE DE 2019	
		DEBE	HABER	DEBE	HABER	DEBE	HABER
41431004003007001	PARA LA COLOCACION DE ANUNCIOS O CARTELES Y LA REALIZACION DE PUBLICIDAD EN LUGARES VISIBLES DESDE LA VIA PUBLICA ANUNCIOS COMERCIALES, MANTAS, LONAS SIN ESTRUCTURA Y CARTELES EN FACHADAS, FACHADAS, MUROS, PAREDES O BARDAS, POR SEMESTRE POR M2	0.00	0.00	0.00	0.00	0.00	9,434.00
41431004003007001	HASTA 2 M2	0.00	0.00	0.00	0.00	0.00	9,434.00
41431004003007003	ANUNCIOS LUMINOSOS, ESPECTACULARES Y ELECTRONICOS POR ANUALIDAD	0.00	0.00	0.00	0.00	0.00	3,086,614.00
41431004003007007	POR PERIFONEO	0.00	0.00	0.00	0.00	0.00	800.00
41431004003007007	AMBULANTE	0.00	0.00	0.00	0.00	0.00	800.00
41431004003008	REGISTRO CIVIL	0.00	0.00	0.00	0.00	0.00	1,241,712.35
41431004003008001	POR ADMINISTRACION DEL REGISTRO CIVIL	0.00	0.00	0.00	0.00	0.00	1,241,712.35
41431004003009	SERVICIOS GENERALES DE PRESTADOS POR LOS CENTROS ANTIRRABICOS MUNICIPALES	0.00	0.00	0.00	0.00	0.00	10,737.00
41431004003009004	ESTERILIZACION DE HEMBRA Y MACHO	0.00	0.00	0.00	0.00	0.00	10,737.00
41431004003010	SERVICIOS MUNICIPALES DE SALUD	0.00	0.00	0.00	0.00	0.00	10,737.00
41431004003010001	DE LA PREVENCION Y CONTROL DE ENFERMEDADES DE TRANSMISION SEXUAL	0.00	0.00	0.00	0.00	0.00	474,576.00
41431004003010002	POR ANALISIS DE LABORATORIOS Y EXPEDICION DE CREDENCIALES	0.00	0.00	0.00	0.00	0.00	144,100.00
41431004003010003	OTROS SERVICIOS MEDICOS	0.00	0.00	0.00	0.00	0.00	124,848.00
41431004003012	REGISTRO Y REFERENDO EN MATERIA PECUARIA	0.00	0.00	0.00	0.00	0.00	205,628.00
41431004003012001	REGISTRO DE FIERRO	0.00	0.00	0.00	0.00	0.00	108,787.00
41431004003012002	REFERENDO DE FIERRO	0.00	0.00	0.00	0.00	0.00	17,668.00
41431004003012006	CERTIFICACION DE DOCUMENTOS	0.00	0.00	0.00	0.00	0.00	90,707.00
4145	Derechos no comprendidos en la Ley de Ingresos Vigente, Causados en Ejercicios Fiscales Anteriores Pendientes de Liquidación o Pago	0.00	0.00	0.00	0.00	0.00	412.00
41451	INGRESOS VIGENTE, CAUSADOS EN LA LEY DE FISCALIA ANTERIORES PENDIENTES DE LIQUIDACION O PAGO	0.00	0.00	0.00	0.00	0.00	700.00
41451001	REZAGOS	0.00	0.00	0.00	0.00	0.00	700.00
41451001007	REFERENDO DE FIERRO	0.00	0.00	0.00	0.00	0.00	700.00
4149	OTROS DERECHOS	0.00	0.00	0.00	0.00	0.00	1,225,265.33
41491	OTROS DERECHOS	0.00	0.00	0.00	0.00	0.00	1,225,265.33
41491004	DERECHOS	0.00	0.00	0.00	0.00	0.00	1,225,265.33
41491004004	OTROS DERECHOS	0.00	0.00	0.00	0.00	0.00	1,225,265.33
41491004004001	DE LA INSTALACION, MANTENIMIENTO Y CONSERVACION DEL ALUMBRADO PUBLICO	0.00	0.00	0.00	0.00	0.00	1,225,265.33
							33.00

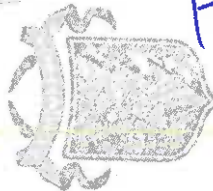
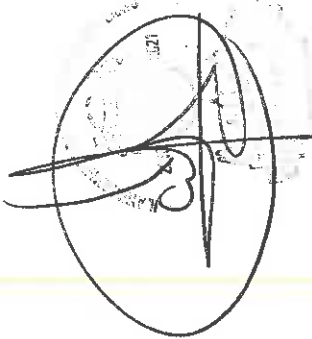
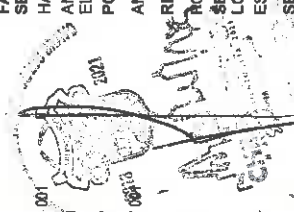

H. Ayuntamiento Municipal Chilpancingo, Gro.  
CONTRALORIA INTERNA MUNICIPAL



H. AYUNTAMIENTO MUNICIPAL DE CHILPANCINGO, GRO.

SECRETARIA DE FINANZAS Y ADMINISTRACION

CONSOLIDADO



BALANZA DE COMPROBACION DEL 1 DE ENERO AL 31 DE DICIEMBRE DEL 2019

C U E N T A	C O N C E P T O	SALDOS INICIALES		MOVIMIENTOS		SALDOS ACUMULADOS	
		AL 1 DE ENERO DE 2019		ENERO - DICIEMBRE 2019		AL 31 DE DICIEMBRE DE 2019	
		DEBE	HABER	DEBE	HABER	DEBE	HABER
41491004004001003	LOCALES COMERCIALES DE PRESTACION DE SERVICIOS RELACIONADOS CON EL TURISMO	0.00	0.00	0.00	33.00	33.00	
41491004004002	PRO-BOMBEROS	0.00	0.00	61.00	440,958.00	440,997.00	
41491004004002001	LICENCIAS PARA CONSTRUCCION DE EDIFICIOS O CASAS HABITACION, RESTAURACION O REPARACION, URBANIZACION	0.00	0.00	61.00	139,327.00	139,266.00	
41491004004002003	FRACCIONAMIENTO, LOTIFICACION, RELOTIFICACION FUSION Y SUBDIVISION	0.00	0.00	0.00	301,631.00	301,631.00	
41491004004002003001	LICENCIAS PERMISOS O AUTORIZACIONES PARA LA COLOCACION DE ANUNCIOS O CARTELES COMERCIALES Y LA REALIZACION DE PUBLICIDAD EN VIA Y LUGARES PUBLICOS	0.00	0.00	0.00	301,631.00	301,631.00	
41491004004002003001	ANUNCIOS FIJOS SIN ESTRUCTURA, (MARQUESINAS, CORTINAS DE PLASTICO (ENROLLABLES), LONAS SIN ESTRUCTURAS Y CARTELES EN FACHADAS, MUROS, PAREDES O BARDAS, POR M2	0.00	0.00	0.00	301,631.00	301,631.00	
41491004004002003001001	HASTA 2 M2	0.00	0.00	0.00	301,631.00	301,631.00	
41491004004004004	PRO-ECOLOGIA	0.00	0.00	0.00	681,637.00	681,637.00	
41491004004004004001	POR VERIFICACION PARA ESTABLECIMIENTO DE UN NUEVO O AMPLIACION DE OBRAS, SERVICIOS, INDUSTRIA Y COMERCIO	0.00	0.00	0.00	39,244.00	39,244.00	
41491004004004002	POR PERMISOS PARA PODA DE ARBOL PUBLICO PRIVADO	0.00	0.00	0.00	61,575.00	61,575.00	
41491004004004003	POR PERMISO POR DERRIBA DE ARBOL PUBLICO PRIVADO, POR CM, DE DIAMETRO	0.00	0.00	0.00	12,403.00	12,403.00	
41491004004004004	AMBIENTE A ESTABLECIMIENTOS MERCANTILES POR AUTORIZACION DE REGISTRO COMO	0.00	0.00	0.00	76,431.00	76,431.00	
41491004004004005	GENERADOS DE EMISIONES CONTAMINANTES A LA ATMOSFERA A ESTABLECIMIENTOS MERCANTILES Y DE SERVICIOS EN FUENTES FIJAS O MOVILES	0.00	0.00	0.00	491,984.00	491,984.00	
41491004004005005	FORMAS DEL REGISTRO CIVIL	0.00	0.00	0.00	102,607.33	102,607.33	
41491004004005005001	FORMAS DEL REGISTRO CIVIL	0.00	0.00	0.00	102,607.33	102,607.33	
41491004005	ACCESORIOS DE DERECHOS	0.00	0.00	0.00	30.00	30.00	
41491004005001	RECARGOS	0.00	0.00	0.00	30.00	30.00	
41491004005001005	AGUA POTABLE, ALCANTARILLADO Y SANEAMIENTO	0.00	0.00	0.00	30.00	30.00	
415	Productos	0.00	0.00	0.00	1,191,156.70	1,191,156.70	
4159	Generan Ingresos Corrientes	0.00	0.00	0.00	1,191,156.70	1,191,156.70	
41591	Generan Ingresos Corrientes	0.00	0.00	0.00	1,191,156.70	1,191,156.70	
41591005	PRODUCTOS	0.00	0.00	0.00	1,191,156.70	1,191,156.70	
41591005001	PRODUCTOS DE TIPO CORRIENTE EXCEPTO LOS CAUSADOS EN EJERCICIOS ANTERIORES	0.00	0.00	0.00	1,191,156.70	1,191,156.70	
41591005001001	ARRENDAMIENTO	0.00	0.00	0.00	137,393.00	137,393.00	

2019

SECRETARIA DE FINANZAS Y ADMINISTRACION

CHILPANCINGO



H. Ayuntamiento Municipal Constituido por el Poder Judicial de Chilpancingo, Gro.  
CONTRALORIA INTERNA



H. AYUNTAMIENTO MUNICIPAL DE CHILPANCINGO, GRO.  
SECRETARIA DE FINANZAS Y ADMINISTRACION  
CONSOLIDADO



BALANZA DE COMPROBACION DEL 1 DE ENERO AL 31 DE DICIEMBRE DEL 2019

C U E N T A	C O N C E P T O	SALDOS INICIALES		MOVIMIENTOS		SALDOS ACUMULADOS	
		AL 1 DE ENERO DE 2019		ENERO - DICIEMBRE 2019		AL 31 DE DICIEMBRE DE 2019	
		DEBE	HABER	DEBE	HABER	DEBE	HABER
41591005001001001	MERCADO CENTRAL	0.00	950.00	0.00	0.00	950.00	950.00
41591005001001002	MERCADO DE ZONA	0.00	93,603.00	0.00	0.00	93,603.00	93,603.00
41591005001001011	ESTACIONAMIENTOS POR HORA O FRACCION POR LOTES EN PROPIEDAD O ARRENDAMIENTO EN LOS CEMENTERIOS MUNICIPALES POR LA CONSTRUCCION DE FOSAS	0.00	42,840.00	0.00	0.00	42,840.00	42,840.00
41591005001002001	FOSA EN PRCP POR M2	0.00	5,257.00	0.00	0.00	5,257.00	5,257.00
41591005001003003	OCCUPACION O APROVECHAMIENTO DE VIA PUBLICA	0.00	5,257.00	0.00	0.00	5,257.00	5,257.00
41591005001003013	PARQUIMETROS	0.00	2,980.00	0.00	0.00	2,980.00	2,980.00
41591005001005001	CORRALON MUNICIPAL	0.00	2,980.00	0.00	0.00	2,980.00	2,980.00
41591005001005001001	POR LOS SERVICIOS DE ARRASTRE DE BIENES MUEBLES AL CORRALON DEL MUNICIPIO	0.00	398,599.00	0.00	0.00	398,599.00	398,599.00
41591005001005001002	MOTOCICLETAS	0.00	375,721.00	0.00	0.00	375,721.00	375,721.00
41591005001005001003	AUTOMOVILES	0.00	47,507.00	0.00	0.00	47,507.00	47,507.00
41591005001005001003	CAMIONETAS	0.00	253,495.00	0.00	0.00	253,495.00	253,495.00
41591005001005002	POR EL DEPOSITO DE BIENES MUEBLES AL CORRALON DEL MUNICIPIO	0.00	74,719.00	0.00	0.00	74,719.00	74,719.00
41591005001005002001	MOTOCICLETAS	0.00	22,878.00	0.00	0.00	22,878.00	22,878.00
41591005001005002002	AUTOMOVILES	0.00	2,289.00	0.00	0.00	2,289.00	2,289.00
41591005001005002003	CAMIONETAS	0.00	5,833.00	0.00	0.00	5,833.00	5,833.00
41591005001005002004	CAMIONES	0.00	3,780.00	0.00	0.00	3,780.00	3,780.00
41591005001015005	PRODUCTOS DIVERSOS	0.00	10,976.00	0.00	0.00	10,976.00	10,976.00
41591005001015005001	VENTA DE LEYES Y REGLAMENTOS	0.00	235,912.13	0.00	0.00	235,912.13	235,912.13
41591005001015005002	VENTA DE FORMAS IMPRESAS POR JUEGOS	0.00	183,256.00	0.00	0.00	183,256.00	183,256.00
41591005001016001	PRODUCTOS FINANCIEROS	0.00	52,656.13	0.00	0.00	52,656.13	52,656.13
41591005001016001001	GASTO CORRIENTE	0.00	411,015.57	0.00	0.00	411,015.57	411,015.57
41591005001016001002	INTERESES POR PRODUCTOS FINANCIEROS	0.00	4,196.58	0.00	0.00	4,196.58	4,196.58
41591005001016002001	FONDO DE APORTE P/INFRA SOC MPAL	0.00	4,196.58	0.00	0.00	4,196.58	4,196.58
41591005001016002002	INTERESES POR PRODUCTOS FINANCIEROS DE EJERCICIOS ANTERIORES	0.00	406,176.94	0.00	0.00	406,176.94	406,176.94
41591005001016003001	FONDO DE APORTE P/PORT DE LOS MPIO	0.00	404,331.60	0.00	0.00	404,331.60	404,331.60
41591005001016003001	INTERESES POR PRODUCTOS FINANCIEROS ANOS ANTERIORES	0.00	1,845.34	0.00	0.00	1,845.34	1,845.34
416	Aprovechamientos	0.00	642.05	0.00	0.00	642.05	642.05
4162	MULTAS	0.00	642.05	0.00	0.00	642.05	642.05
41621	MULTAS	0.00	4,666,866.21	0.00	0.00	4,666,866.21	4,666,866.21
		0.00	3,733,127.71	0.00	0.00	3,733,127.71	3,733,127.71
		0.00	3,733,127.71	0.00	0.00	3,733,127.71	3,733,127.71

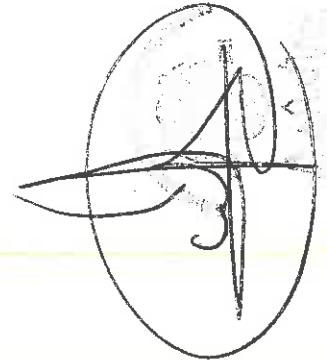

H. Ayuntamiento Municipal de Chilpancingo  
SECRETARIA DE FINANZAS Y ADMINISTRACION  
CONTRALORIA INTERNA MUNICIPAL





H. AYUNTAMIENTO MUNICIPAL DE CHILPANCINGO, GRO.

SECRETARIA DE FINANZAS Y ADMINISTRACION

CONSOLIDADO



BALANZA DE COMPROBACIÓN DEL 1 DE ENERO AL 31 DE DICIEMBRE DEL 2019

C U E N T A	C O N C E P T O	SALDOS INICIALES		MOVIMIENTOS		SALDOS ACUMULADOS	
		AL 1 DE ENERO DE 2019		ENERO - DICIEMBRE 2019		AL 31 DE DICIEMBRE DE 2019	
		DEBE	HABER	DEBE	HABER	DEBE	HABER
41621006	APROVECHAMIENTOS	0.00	0.00	0.00	3,733,127.71	3,733,127.71	3,733,127.71
41621006001	APROVECHAMIENTOS DE TIPO CORRIENTE	0.00	0.00	0.00	3,733,127.71	3,733,127.71	3,733,127.71
41621006001001	MULTAS FISCALES	0.00	0.00	0.00	278,241.71	278,241.71	278,241.71
41621006001001001	FALTAS DE CUMPLIMIENTO DE OBLIGACIONES FISCALES	0.00	0.00	0.00	278,241.71	278,241.71	278,241.71
41621006001002	MULTAS ADMINISTRATIVAS	0.00	0.00	0.00	372,630.00	372,630.00	372,630.00
41621006001002001	LOS QUE TRANSGREDAN EL BANDO DE POLICIA Y BUEN GOBIERNO Y EN SUS REGLAMENTOS MUNICIPALES	0.00	0.00	0.00	372,630.00	372,630.00	372,630.00
41621006001003	MULTAS DE TRANSITO LOCAL	0.00	0.00	0.00	3,016,373.00	3,016,373.00	3,016,373.00
41621006001003001	PARTICULARES	0.00	0.00	0.00	2,436,385.00	2,436,385.00	2,436,385.00
41621006001003002	SERVICIO PUBLICO	0.00	0.00	0.00	579,988.00	579,988.00	579,988.00
41621006001005	MULTAS POR CONCEPTO DE PROTECCION AL MEDIO AMBIENTE (ECOLOGIA)	0.00	0.00	0.00	65,883.00	65,883.00	65,883.00
41621006001005001	DE LAS MULTAS DE ECOLOGIA	0.00	0.00	0.00	65,883.00	65,883.00	65,883.00
4163	INDEMNIZACIONES	0.00	0.00	0.00	308,623.00	308,623.00	308,623.00
41631	INDEMNIZACIONES	0.00	0.00	0.00	308,623.00	308,623.00	308,623.00
41631006	APROVECHAMIENTOS	0.00	0.00	0.00	308,623.00	308,623.00	308,623.00
41631006001	APROVECHAMIENTOS DE TIPO CORRIENTE	0.00	0.00	0.00	308,623.00	308,623.00	308,623.00
41631006001013	GASTOS DE NOTIFICACION Y EJECUCION POR DILIGENCIAS QUE SE PRACTIQUEN CONFORME AL CODIGO FISCAL MUNICIPAL	0.00	0.00	0.00	308,623.00	308,623.00	308,623.00
41631006001013001	OTROS APROVECHAMIENTOS	0.00	0.00	0.00	308,623.00	308,623.00	308,623.00
4169	OTROS APROVECHAMIENTOS	0.00	0.00	0.00	625,115.50	625,115.50	625,115.50
41691	APROVECHAMIENTOS	0.00	0.00	0.00	625,115.50	625,115.50	625,115.50
41691006	APROVECHAMIENTOS DE TIPO CORRIENTE	0.00	0.00	0.00	625,115.50	625,115.50	625,115.50
41691006001	DONATIVOS Y LEGADOS	0.00	0.00	0.00	619,213.50	619,213.50	619,213.50
41691006001006	DE PARTICULARES	0.00	0.00	0.00	619,213.50	619,213.50	619,213.50
41691006001006001	DE PARTICULARES	0.00	0.00	0.00	619,213.50	619,213.50	619,213.50
41691006009	EJERCICIOS ANTERIORES	0.00	0.00	0.00	5,902.00	5,902.00	5,902.00
41691006009001	APROVECHAMIENTOS CAUSADOS EN EJERCICIOS ANTERIORES	0.00	0.00	0.00	5,902.00	5,902.00	5,902.00
41691006009001001	DONATIVOS Y LEGADOS	0.00	0.00	0.00	5,902.00	5,902.00	5,902.00
42	PARTICIPACIONES, APORTACIONES, TRANSFERENCIAS, ASIGNACIONES, SUBSIDIOS Y OTRAS AYUDAS	0.00	0.00	0.42	765,281,538.14	765,281,537.72	765,281,537.72
421	Incentivos Derivados de la Colaboración Fiscal y FONDOS Distintos de Aportaciones	0.00	0.00	0.42	765,281,538.14	765,281,537.72	765,281,537.72

SECRETARIA DE FINANZAS Y ADMINISTRACION  
 2019

AYUNTAMIENTO MUNICIPAL DE CHILPANCINGO  
 SECRETARIA DE FINANZAS Y ADMINISTRACION  
 2019



H. AYUNTAMIENTO MUNICIPAL DE CHILPANCINGO, GRO.

SECRETARIA DE FINANZAS Y ADMINISTRACION

CONSOLIDADO



BALANZA DE COMPROBACIÓN DEL 1 DE ENERO AL 31 DE DICIEMBRE DEL 2019

C U E N T A	C O N C E P T O	SALDOS INICIALES		MOVIMIENTOS		SALDOS ACUMULADOS	
		AL 1 DE ENERO DE 2019		ENERO - DICIEMBRE 2019		AL 31 DE DICIEMBRE DE 2019	
		DEBE	HABER	DEBE	HABER	DEBE	HABER
4211	PARTICIPACIONES	0.00		0.00		339,225,221.10	
42111	PARTICIPACIONES	0.00		0.00		339,225,221.10	
42111008	PARTICIPACIONES Y APORTACIONES	0.00		0.00		339,225,221.10	
42111008001	PARTICIPACIONES	0.00		0.00		339,225,221.10	
42111008001001	LAS PROV DEL FONDO GRAL DE PARTICIPACION	0.00		0.00		226,470,520.00	
42111008001001001	FONDO COMUN	0.00		0.00		142,872,587.28	
42111008001001002	FONDO DE FOMENTO MUNICIPAL	0.00		0.00		44,287,100.15	
42111008001001003	FONDO PARA LA INFRAESTRUCTURA A MUNICIPIOS	0.00		0.00		11,054,127.75	
42111008001001004	FONDO DE APORTACIONES ESTATALES PARA LA INFRAESTRUCTURA SOCIAL MUNICIPAL	0.00		0.00		15,967,509.08	
42111008001001005	FONDO DE ESTABILIZACION EN LA ENT. FEDERATIVAS (FEIEF)	0.00		0.00		10,811,505.85	
42111008001001008	PARTICIPACIONES FEDERALES A MUNICIPIOS 2018 (RENDIMIENTOS)	0.00		0.00		1,477,689.89	
42111008001002	DESCUENTO A LAS PARTICIPACIONES	0.00		0.00		41,666,954.62	
42111008001002001	SECRETARIA DE FINANZAS (DESC. ISSSTE)	0.00		0.00		12,576,634.80	
42111008001002002	FONDO DE AHORRO PARA CONTINGENCIAS	0.00		0.00		20,658,057.22	
42111008001002003	FONDO DE SOLIDARIDAD	0.00		0.00		1,661,825.00	
42111008001002004	ESTAMO P/CONTINGENCIAS FINANCIERAS	0.00		0.00		1,500,000.00	
42111008001002014	INGRS POR CUENTA DE CAPACH	0.00		0.00		5,270,437.60	
42111008001003	OTROS INGRESOS EXTRAORDINARIOS	0.00		0.00		71,087,746.48	
42111008001003006	APORT. GOBIERNO DEL ESTADO PARA CAPACH	0.00		0.00		7,000,000.00	
42111008001003008	APORT. GOBIERNO DEL ESTADO PARA EL PATRONATO DE LA FERIA DE SAN MATEO, NAVIDAD Y AÑO NUEVO	0.00		0.00		4,000,000.00	
42111008001003015	APORTACION EXTRAORDINARIA 2% SOBRE REMUNERACION AL TRAB. PERSONAL	0.00		0.00		4,713,229.10	
42111008001003016	APOYO FINANCIERO EXTRAORDINARIO PARA CONTINGENCIAS DE FIN DE AÑO	0.00		0.00		20,071,221.49	
42111008001003017	REVOLUCION ISR	0.00		0.00		7,992,487.00	
42111008001003018	DEVOLUCION ISR (CAPACH)	0.00		0.00		10,655,563.00	
42111008001003019	APOYO FINANCIERO PARA CONTINGENCIAS ECONOMICAS	0.00		0.00		14,928,778.51	
42111008001003020	RECAUDACION DE ISR CAPACH.	0.00		0.00		977,228.30	
42111008001003021	APOYO FINANCIERO PARA CONTINGENCIAS ECONOMICAS (CAPACH)	0.00		0.00		749,239.08	
4212	APORTACIONES	0.00		0.00		396,582,209.39	
42121	APORTACIONES	0.00		0.00		396,582,209.39	
42121008	PARTICIPACIONES Y APORTACIONES	0.00		0.00		396,582,209.39	

Handwritten signature and stamp of the Secretary of Finance and Administration.



H. Ayuntamiento Municipal Constitucional de Chilpancingo, Gro. CONTRALORIA INTERNA MUNICIPAL



H. AYUNTAMIENTO MUNICIPAL DE CHILPANCINGO, GRO.  
SECRETARIA DE FINANZAS Y ADMINISTRACION  
CONSOLIDADO



BALANZA DE COMPROBACION DEL 1 DE ENERO AL 31 DE DICIEMBRE DEL 2019

C U E N T A	C O N C E P T O	SALDOS INICIALES		MOVIMIENTOS				SALDOS ACUMULADOS	
		AL 1 DE ENERO DE 2019		ENERO - DICIEMBRE 2019		AL 31 DE DICIEMBRE DE 2019			
		DEBE	HABER	DEBE	HABER	DEBE	HABER	DEBE	HABER
42121008002	APORTACIONES		0.00	0.00	0.00	386,582,209.39		386,582,209.39	
42121008002001	FONDO DE APORTE P/INFRA SOC MPAL		0.00	0.00	0.00	210,132,906.39		210,132,906.39	
42121008002001001	APORTACIONES P/INFRA SOC MPAL		0.00	0.00	0.00	210,132,906.39		210,132,906.39	
42121008002002	FONDO DE APORTE P/FORT DE LOS MPIO		0.00	0.00	0.00	186,449,303.00		186,449,303.00	
42121008002002001	APORTACIONES P/FORT DE LOS MPIO		0.00	0.00	0.00	186,449,303.00		186,449,303.00	
42121008002002005	RENDIMIENTO POR PRESTAMOS ENTRE PROGRAMAS		0.00	0.00	0.00	17,974.00		17,974.00	
4213	CONVENIOS		0.00	0.00	0.00	29,474,107.65		29,474,107.65	
42131	CONVENIOS		0.00	0.00	0.00	29,474,107.65		29,474,107.65	
42131008	PARTICIPACIONES Y APORTACIONES		0.00	0.00	0.00	29,474,107.65		29,474,107.65	
42131008003	CONVENIOS		0.00	0.00	0.00	29,474,107.65		29,474,107.65	
42131008003002	PROVENIENTES DEL GOBIERNO FEDERAL		0.00	0.00	0.00	29,474,107.65		29,474,107.65	
42131008003002001	FORTASEG		0.00	0.00	0.00	29,474,107.65		29,474,107.65	
42131008003002001004	APORTACION FORTASEG		0.00	0.00	0.00	26,365,585.82		26,365,585.82	
42131008003002001005	RENDIMIENTOS FORTASEG		0.00	0.00	0.00	26,259,709.00		26,259,709.00	
42131008003002007	CONTINGENCIAS ECONOMICAS RAMO 23		0.00	0.00	0.00	105,876.82		105,876.82	
42131008003002007003	RENDIMIENTOS PROGRAMA REGIONALES 6		0.00	0.00	0.00	101.73		101.73	
42131008003002007003003	EJERCICIOS ANTERIORES		0.00	0.00	0.00	101.73		101.73	
42131008003002007003003003	PROGRAMA FORTALECE		0.00	0.00	0.00	0.10		0.10	
42131008003002007003003003003	RENDIMIENTOS DE LA OBRA REMODELACION DE LA ASENIDA JUAN N. ALVAREZ TRAMO DEL PARGUE UNIDOS POR GUERRERO A LA CALLE LOS BRAVO		0.00	0.00	0.00	0.10		0.10	
42131008003002007003003003003003	PROGRAMA PRODDER-CONAGUA		0.00	0.00	0.00	3,108,420.00		3,108,420.00	
5	APORTACION PROGRAMA PRODDER		0.00	0.00	0.00	3,108,386.00		3,108,386.00	
51	RENDIMIENTOS PROGRAMA PRODDER		0.00	0.00	0.00	34.00		34.00	
511	GASTOS Y OTRAS PERDIDAS		0.00	0.00	0.00	961,750,477.88		961,750,477.88	
5111	GASTOS DE FUNCIONAMIENTO		0.00	0.00	0.00	706,817,080.91		706,817,080.91	
51111	SERVICIOS PERSONALES		0.00	0.00	0.00	543,440,037.50		543,440,037.50	
511111	REMUNERACIONES AL PERSONAL PERMANENTE		0.00	0.00	0.00	201,504,647.65		201,504,647.65	
5111111	SUELDOS BASE AL PERSONAL PERMANENTE		0.00	0.00	0.00	201,504,647.65		201,504,647.65	
51111111	GASTO CORRIENTE		0.00	0.00	0.00	163,634,711.85		163,634,711.85	
51111111001	SUELDOS BASE		0.00	0.00	0.00	163,634,711.85		163,634,711.85	
51111111001001	SEGURIDAD PUBLICA		0.00	0.00	0.00	37,869,935.80		37,869,935.80	
51111111001001001			0.00	0.00	0.00	79,221.14		79,221.14	

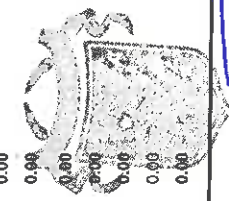
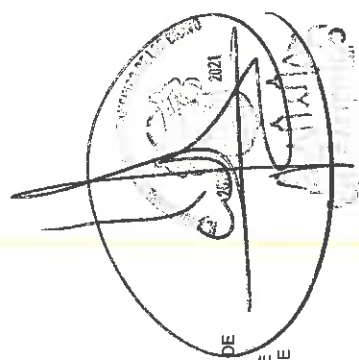



H. AYUNTAMIENTO MUNICIPAL DE CHILPANCINGO, GRO.  
SECRETARIA DE FINANZAS Y ADMINISTRACION  
CONSOLIDADO



BALANZA DE COMPROBACION DEL 1 DE ENERO AL 31 DE DICIEMBRE DEL 2019

C U E N T A	C O N C E P T O	SALDOS INICIALES		MOVIMIENTOS		SALDOS ACUMULADOS	
		AL 1 DE ENERO DE 2019		ENERO - DICIEMBRE 2019		AL 31 DE DICIEMBRE DE 2019	
		DEBE	HABER	DEBE	HABER	DEBE	HABER
511311303001	SUELDOS BASE	0.00		37,869,936.80	79,221.14	37,790,714.66	
5112	REMUNERACIONES AL PERSONAL DE CARÁCTER TRANSITORIO	0.00		2,612,994.51	0.00	2,612,994.51	
51122	SUELDOS BASE AL PERSONAL EVENTUAL	0.00		2,612,994.51	0.00	2,612,994.51	
51122122	SUELDOS BASE AL PERSONAL EVENTUAL	0.00		2,612,994.51	0.00	2,612,994.51	
51122122001	GASTO CORRIENTE	0.00		2,609,994.51	0.00	2,609,994.51	
51122122001001	SUELDOS BASE AL PERSONAL EVENTUAL	0.00		2,609,994.51	0.00	2,609,994.51	
51122122003	SEGURIDAD PUBLICA	0.00		3,000.00	0.00	3,000.00	
51122122003001	SUELDOS BASE AL PERSONAL EVENTUAL	0.00		3,000.00	0.00	3,000.00	
5113	REMUNERACIONES ADICIONALES Y ESPECIALES	0.00		240,047,268.93	26,034.50	240,021,234.43	
51131	PRIMAS POR AÑOS DE SERVICIOS EFECTIVOS	0.00		3,103,281.20	0.00	3,103,281.20	
51131131	PRIMAS POR AÑOS DE SERVICIO EFECTIVO PRESTADOS	0.00		2,855,067.20	0.00	2,855,067.20	
51131131001	GASTO CORRIENTE	0.00		2,661,054.36	0.00	2,661,054.36	
51131131001001	PRIMA QUINCENAL POR AÑOS DE SERVICIOS EFECTIVOS PRESTADOS	0.00		2,661,054.36	0.00	2,661,054.36	
51131131003	SEGURIDAD PUBLICA	0.00		194,012.84	0.00	194,012.84	
51131131003001	PRIMA QUINCENAL POR AÑOS DE SERVICIOS EFECTIVOS PRESTADOS	0.00		194,012.84	0.00	194,012.84	
51131138	CUMPLIMIENTO DE LAS LEYES Y CUSTODIA DE VALORES	0.00		248,214.00	0.00	248,214.00	
51131138002	PARTICIPACIONES EN MULTAS ADMINISTRATIVAS	0.00		248,214.00	0.00	248,214.00	
51131138002021	FONDO GENERAL DE PARTICIPACIONES	0.00		248,214.00	0.00	248,214.00	
51131138002021001	EJERCICIO 2019	0.00		248,214.00	0.00	248,214.00	
51132	2% CREDITOS FISCALES	0.00		56,406,605.20	0.00	56,406,605.20	
51132132	PRIMAS DE VACACIONES, DOMINICAL Y GRATIFICACION DE FIN DE AÑO	0.00		56,406,605.20	0.00	56,406,605.20	
51132132001	GASTO CORRIENTE	0.00		46,798,717.73	0.00	46,798,717.73	
51132132001001	PRIMA DE VACACIONES Y DOMINICAL	0.00		8,427,261.77	0.00	8,427,261.77	
51132132002	AGUINALDO Y GRATIFICACION DE FIN DE AÑO	0.00		38,371,455.96	0.00	38,371,455.96	
51132132003	SEGURIDAD PUBLICA	0.00		9,607,887.47	0.00	9,607,887.47	
51132132003001	PRIMA DE VACACIONES Y DOMINICAL	0.00		977,711.22	0.00	977,711.22	
51132132003002	GRATIFICACION DE FIN DE AÑO	0.00		8,630,176.25	0.00	8,630,176.25	
51133	HORAS EXTRAORDINARIAS	0.00		298,015.55	0.00	298,015.55	
51133133	HORAS EXTRAORDINARIAS	0.00		298,015.55	0.00	298,015.55	
51133133001	GASTO CORRIENTE	0.00		298,015.55	0.00	298,015.55	

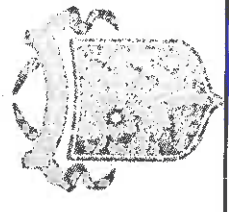
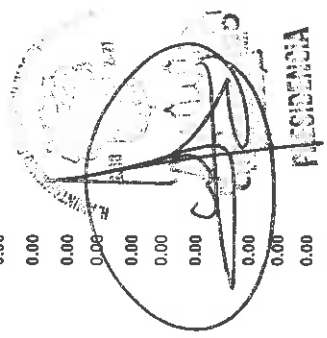

M. Ayuntamiento Municipal Constitucional de Chilpancingo, Gro. CONTRALORIA MUNICIPAL



H. AYUNTAMIENTO MUNICIPAL DE CHILPANCINGO, GRO.  
SECRETARIA DE FINANZAS Y ADMINISTRACION  
CONSOLIDADO



BALANZA DE COMPROBACIÓN DEL 1 DE ENERO AL 31 DE DICIEMBRE DEL 2019

C U E N T A	C O N C E P T O	SALDOS INICIALES		MOVIMIENTOS		SALDOS ACUMULADOS	
		AL 1 DE ENERO DE 2019		ENERO - DICIEMBRE 2019		AL 31 DE DICIEMBRE DE 2019	
		DEBE	HABER	DEBE	HABER	DEBE	HABER
51133133001001	REMUNERACIONES POR HORAS EXTRAORDINARIAS	0.00		298,015.55	0.00	298,015.55	
51134	COMPENSACIONES	0.00		180,239,366.98	26,034.50	180,213,332.48	
51134134	COMPENSACIONES	0.00		180,239,366.98	26,034.50	180,213,332.48	
51134134001	GASTO CORRIENTE	0.00		147,580,486.73	13,000.00	147,567,486.73	
51134134001001	COMPENSACION	0.00		2,643,403.63	0.00	2,643,403.63	
51134134001002	COMPENSACION ADICIONAL FIJO	0.00		125,830,965.07	0.00	125,830,965.07	
51134134001003	COMPENSACION MENSUAL	0.00		554,000.00	13,000.00	541,000.00	
51134134001004	COMPENSACIONES POR SERVICIOS EVENTUALES	0.00		18,552,118.03	0.00	18,552,118.03	
51134134003	SEGURIDAD PUBLICA	0.00		32,658,880.25	13,034.50	32,645,845.75	
51134134003001	COMPENSACION	0.00		516,443.07	0.00	516,443.07	
51134134003002	COMPENSACION ADICIONAL FIJO	0.00		28,290,637.18	1,034.50	28,289,602.68	
51134134003003	COMPENSACION MENSUAL	0.00		3,790,000.00	12,000.00	3,778,000.00	
51134134003004	COMPENSACIONES POR SERVICIOS EVENTUALES	0.00		61,800.00	0.00	61,800.00	
5114	SEGURIDAD SOCIAL	0.00		44,070,692.51	0.00	44,070,692.51	
51141	APORTACIONES DE SEGURIDAD SOCIAL	0.00		43,038,527.05	0.00	43,038,527.05	
51141141	APORTACIONES DE SEGURIDAD SOCIAL	0.00		43,038,527.05	0.00	43,038,527.05	
51141141001	GASTO CORRIENTE	0.00		34,958,208.63	0.00	34,958,208.63	
51141141001001	APORTACIONES AL ISSSTE	0.00		9,742,532.81	0.00	9,742,532.81	
51141141001002	APORTACIONES AL ISSSPEG	0.00		25,215,675.82	0.00	25,215,675.82	
51141141003	SEGURIDAD PUBLICA	0.00		8,080,318.42	0.00	8,080,318.42	
51141141003001	APORTACIONES AL ISSSTE	0.00		2,974,669.67	0.00	2,974,669.67	
51141141003002	APORTACIONES AL ISSSPEG	0.00		5,105,648.75	0.00	5,105,648.75	
51144	APORTACIONES PARA SEGUROS	0.00		1,032,165.46	0.00	1,032,165.46	
51144144	APORTACIONES PARA SEGUROS	0.00		1,032,165.46	0.00	1,032,165.46	
51144144001	GASTO CORRIENTE	0.00		26,200.00	0.00	26,200.00	
51144144001004	CUOTAS PARA SEGURO DE VIDA DEL PERSONAL	0.00		26,200.00	0.00	26,200.00	
51144144003	SEGURIDAD PUBLICA	0.00		1,005,965.46	0.00	1,005,965.46	
51144144003004	SEGUROS DE VIDA	0.00		1,005,965.46	0.00	1,005,965.46	
5115	OTRAS PRESTACIONES SOCIALES Y ECONOMICAS	0.00		52,071,721.16	69,231.87	52,002,489.29	
51152	INDEMNIZACIONES	0.00		4,682,685.66	69,231.87	4,613,453.79	
51152152	INDEMNIZACIONES	0.00		4,682,685.66	69,231.87	4,613,453.79	
51152152001	GASTO CORRIENTE	0.00		569,677.17	69,231.87	500,445.30	

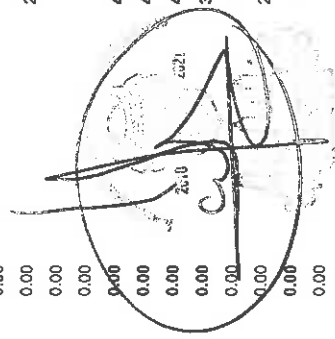





H. AYUNTAMIENTO MUNICIPAL DE CHILPANCINGO, GRO.

SECRETARIA DE FINANZAS Y ADMINISTRACION

CONSOLIDADO



BALANZA DE COMPROBACION DEL 1 DE ENERO AL 31 DE DICIEMBRE DEL 2019

C U E N T A	C O N C E P T O	SALDOS INICIALES		MOVIMIENTOS		SALDOS ACUMULADOS	
		AL 1 DE ENERO DE 2019		ENERO - DICIEMBRE 2019		AL 31 DE DICIEMBRE DE 2019	
		DEBE	HABER	DEBE	HABER	DEBE	HABER
51152152001002	PAGO LIQUIDACIONES	0.00		569,677.17	69,231.87	500,445.30	
51152152003	SEGURIDAD PUBLICA	0.00		4,113,008.49	0.00	4,113,008.49	
51152152003002	PAGO DE LIQUIDACIONES	0.00		4,113,008.49	0.00	4,113,008.49	
51154	PRESTACIONES CONTRACTUALES	0.00		27,567,899.58	0.00	27,567,899.58	
51154154	PRESTACIONES CONTRACTUALES	0.00		27,567,899.58	0.00	27,567,899.58	
51154154001	GASTO CORRIENTE	0.00		13,156,075.15	0.00	13,156,075.15	
51154154001001	PRESTACIONES ESTABLECIDAS EN LAS CONDICIONES GENERALES DEL TRABAJO O CONTRATOS COLECTIVOS DE TRABAJO	0.00		2,892,310.55	0.00	2,892,310.55	
51154154001001	AYUDAS PARA DESPESA AL PERSONAL	0.00		1,063,410.50	0.00	1,063,410.50	
51154154001003	INGRESO POR SERVICIO	0.00		5,186,316.71	0.00	5,186,316.71	
51154154001004	AYUDA PARA TRANSPORTE	0.00		1,820,227.39	0.00	1,820,227.39	
51154154001005	VIDA CARA	0.00		2,193,810.00	0.00	2,193,810.00	
51154154001006	SEGURIDAD PUBLICA	0.00		14,411,824.43	0.00	14,411,824.43	
51154154003003	AYUDAS PARA DESPESA AL PERSONAL	0.00		81,902.25	0.00	81,902.25	
51154154003004	INGRESO POR SERVICIO	0.00		14,026,235.81	0.00	14,026,235.81	
51154154003005	AYUDA PARA TRANSPORTE	0.00		140,360.37	0.00	140,360.37	
51154154003006	OTRAS PRESTACIONES SOCIALES Y ECONOMICAS	0.00		169,326.00	0.00	169,326.00	
51159	OTRAS PRESTACIONES SOCIALES Y ECONOMICAS	0.00		19,821,135.92	0.00	19,821,135.92	
51159159	GASTO CORRIENTE	0.00		19,821,135.92	0.00	19,821,135.92	
51159159001	OTRAS PRESTACIONES SOCIALES Y ECONOMICAS	0.00		15,868,323.24	0.00	15,868,323.24	
51159159001001	BONO PARA MEJORAS LABORALES (APORTACION AL PROG FORTASEG)	0.00		142,242.32	0.00	142,242.32	
51159159001004	PREVISION SOCIAL	0.00		5,203,941.80	0.00	5,203,941.80	
51159159001005	BONO DE DIA DE LAS MADRES	0.00		1,795,081.50	0.00	1,795,081.50	
51159159001006	GASTOS FUNERARIOS	0.00		3,944,896.00	0.00	3,944,896.00	
51159159001007	BONO DE DIA DEL PADRE	0.00		132,790.86	0.00	132,790.86	
51159159001008	BONO EDUCATIVO	0.00		472,500.00	0.00	472,500.00	
51159159001010	BONO DEL DIA DEL SERVIDOR PUBLICO	0.00		858,370.76	0.00	858,370.76	
51159159001011	BONO DEL DIA DE PROTECCION CIVIL	0.00		3,311,000.00	0.00	3,311,000.00	
51159159003	SEGURIDAD PUBLICA	0.00		7,500.00	0.00	7,500.00	
51159159003001	OTRAS PRESTACIONES	0.00		3,952,812.68	0.00	3,952,812.68	
51159159003002	GASTOS FUNERARIOS	0.00		172,007.31	0.00	172,007.31	
		0.00		22,988.19	0.00	22,988.19	

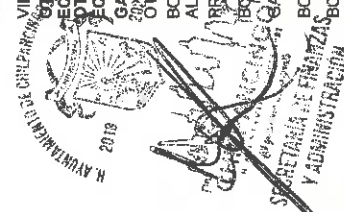





H. AYUNTAMIENTO MUNICIPAL DE CHILPANCINGO, GRO.  
SECRETARIA DE FINANZAS Y ADMINISTRACION  
CONSOLIDADO



BALANZA DE COMPROBACION DEL 1 DE ENERO AL 31 DE DICIEMBRE DEL 2019

C U E N T A	C O N C E P T O	SALDOS INICIALES		MOVIMIENTOS		SALDOS ACUMULADOS	
		AL 1 DE ENERO DE 2019		ENERO - DICIEMBRE 2019		AL 31 DE DICIEMBRE DE 2019	
		DEBE	HABER	DEBE	HABER	DEBE	HABER
51159159003005	PREVISION SOCIAL	0.00		140,246.10	0.00	140,246.10	
51159159003006	BONO DE DIA DE LAS MADRES	0.00		821,192.00	0.00	821,192.00	
51159159003007	BONO DE DIA DEL PADRE	0.00		229,500.00	0.00	229,500.00	
51159159003008	BONO DEL DIA DEL BOMBERO	0.00		300,000.00	0.00	300,000.00	
51159159003009	BONO PARA MEJORAS LABORALES	0.00		220,000.00	0.00	220,000.00	
51159159003010	BONO EDUCATIVO	0.00		581,554.08	0.00	581,554.08	
51159159003011	BONO DEL DIA DEL SERVIDOR PUBLICO	0.00		397,000.00	0.00	397,000.00	
51159159003012	BONO DEL DIA DE PROTECCION CIVIL	0.00		300,825.00	0.00	300,825.00	
51159159003013	BONO DEL DIA DE AGENTE DE TRANSITO	0.00		767,500.00	0.00	767,500.00	
5116	PAGO DE ESTIMULOS A SERVIDORES PUBLICOS	0.00		3,132,712.74	0.00	3,132,712.74	
51161	PREVISIONES DE CARÁCTER LABORAL, ECONOMICA Y DE SEGURIDAD SOCIAL	0.00		3,132,712.74	0.00	3,132,712.74	
51161161	ESTIMULOS	0.00		854,962.74	0.00	854,962.74	
51161161003	SEGURIDAD PUBLICA	0.00		854,962.74	0.00	854,962.74	
51161161003002	ESTIMULOS AL PERSONAL OPERATIVO	0.00		770,162.74	0.00	770,162.74	
51161161003007	ESTIMULOS POR AÑOS DE SERVICIO	0.00		84,800.00	0.00	84,800.00	
51161171	ESTIMULOS	0.00		2,277,750.00	0.00	2,277,750.00	
51161171001	GASTO CORRIENTE	0.00		2,277,750.00	0.00	2,277,750.00	
51161171001001	ESTIMULOS POR PRODUCTIVIDAD Y EFICIENCIA	0.00		620,000.00	0.00	620,000.00	
51161171001002	ESTIMULOS AL PERSONAL OPERATIVO	0.00		2,750.00	0.00	2,750.00	
51161171001003	ESTIMULOS POR AÑOS DE SERVICIO	0.00		1,655,000.00	0.00	1,655,000.00	
512	MATERIALES Y SUMINISTROS	0.00		47,885,694.97	451,842.21	47,433,852.76	
5121	MATERIALES DE ADMINISTRACIÓN, EMISIÓN DE DOCUMENTOS Y ARTICULOS OFICIALES	0.00		11,965,380.20	222,445.90	11,762,934.30	
51211	MATERIALES, ÚTILES Y EQUIPOS MENORES DE OFICINA	0.00		7,580,725.40	43,365.35	7,557,360.05	
51211211	MATERIALES, ÚTILES Y EQUIPOS MENORES DE OFICINA	0.00		7,580,725.40	43,365.35	7,557,360.05	
51211211003	GASTO CORRIENTE	0.00		7,530,655.70	43,365.35	7,487,290.35	
51211211003001	MATERIALES Y ÚTILES DE OFICINA	0.00		7,530,655.70	43,365.35	7,487,290.35	
51211211003002	SEGURIDAD PUBLICA	0.00		26,769.70	0.00	26,769.70	
51211211003003	MATERIALES Y ÚTILES DE OFICINA	0.00		26,769.70	0.00	26,769.70	
51211211007	FORTASEG	0.00		23,300.00	0.00	23,300.00	
51211211007002	MATERIALES Y ÚTILES PARA EVALUACIONES DE DESEMPEÑO	0.00		12,300.00	0.00	12,300.00	
51211211007003	MATERIAL Y EQUIPO MENOR PARA IMPRESION	0.00		11,000.00	0.00	11,000.00	
51212	MATERIALES Y ÚTILES DE IMPRESIÓN Y	0.00		825,086.95	0.00	825,086.95	

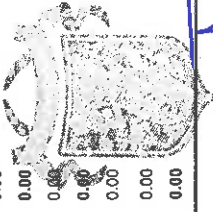
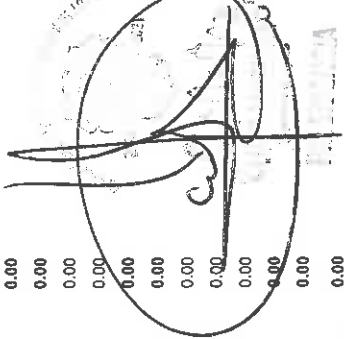
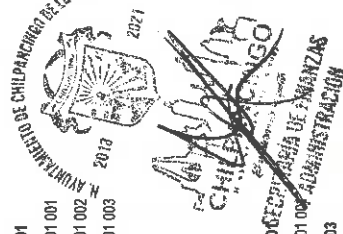
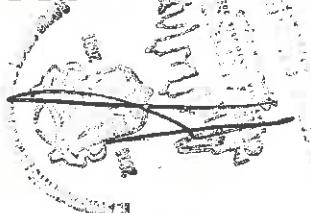



H. AYUNTAMIENTO MUNICIPAL DE CHILPANCINGO, GRO.

SECRETARIA DE FINANZAS Y ADMINISTRACION

CONSOLIDADO



BALANZA DE COMPROBACIÓN DEL 1 DE ENERO AL 31 DE DICIEMBRE DEL 2019

C U E N T A	C O N C E P T O	SALDOS INICIALES		MOVIMIENTOS		SALDOS ACUMULADOS	
		AL 1 DE ENERO DE 2019		ENERO - DICIEMBRE 2019		AL 31 DE DICIEMBRE DE 2019	
		DEBE	HABER	DEBE	HABER	DEBE	HABER
51212212	REPRODUCCIÓN	0.00		825,086.95	0.00	825,086.95	
51212212001	MATERIALES Y UTILES DE IMPRESIÓN Y REPRODUCCION	0.00		569,994.44	0.00	569,994.44	
51212212001001	GASTO CORRIENTE	0.00		569,994.44	0.00	569,994.44	
51212212003	MATERIALES DE IMPRESIÓN Y FORMAS OFICIALES	0.00		255,092.51	0.00	255,092.51	
51212212003001	SEGURIDAD PUBLICA	0.00		255,092.51	0.00	255,092.51	
51214	MATERIALES Y UTILES DE IMPRESION Y REPRODUCCION	0.00		1,604,965.50	33,175.93	1,571,789.57	
51214214	MATERIALES, UTILES Y EQUIPOS MENORES DE TECNOLOGIAS DE LA INFORMACION Y COMUNICACIONES	0.00		1,604,965.50	33,175.93	1,571,789.57	
51214214001	GASTO CORRIENTE	0.00		1,243,307.52	33,175.93	1,210,131.59	
51214214001001	MATERIALES UTILES PARA EL PROCESAMIENTO DE EQUIPOS INFORMATICOS	0.00		1,243,307.52	33,175.93	1,210,131.59	
51214214002	OBRA PUBLICA	0.00		8,686.08	0.00	8,686.08	
51214214002002	DISCOS DURCS EXTERNOS (PRODIM)	0.00		8,686.08	0.00	8,686.08	
51214214003	SEGURIDAD PUBLICA	0.00		352,971.90	0.00	352,971.90	
51214214003001	MATERIALES UTILES PARA EL PROCESAMIENTO DE EQUIPOS INFORMATICOS	0.00		352,971.90	0.00	352,971.90	
51215	MATERIAL IMPRESO E INFORMACION DIGITAL	0.00		10,450.00	0.00	10,450.00	
51215215	GASTO CORRIENTE	0.00		10,450.00	0.00	10,450.00	
51215215001	MATERIAL DE APOYO INFORMATIVO	0.00		10,450.00	0.00	10,450.00	
51215215001001	MATERIAL DE LIMPIEZA	0.00		10,450.00	0.00	10,450.00	
51216	MATERIAL DE LIMPIEZA	0.00		1,964,152.35	145,904.62	1,818,247.73	
51216216	GASTO CORRIENTE	0.00		1,964,152.35	145,904.62	1,818,247.73	
51216216001	DE ASEO Y LIMPIEZA	0.00		1,952,802.23	145,904.62	1,806,897.61	
51216216001001	SEGURIDAD PUBLICA	0.00		1,952,802.23	145,904.62	1,806,897.61	
51216216003	DE ASEO Y LIMPIEZA	0.00		11,350.12	0.00	11,350.12	
5122	ALIMENTOS Y UTENSILIOS	0.00		11,350.12	0.00	11,350.12	
51221	PRODUCTOS ALIMENTICIOS PARA PERSONAS	0.00		632,867.68	16,595.89	616,271.79	
51221221	PRODUCTOS ALIMENTICIOS PARA PERSONAS	0.00		632,867.68	16,595.89	616,271.79	
51221221001	GASTO CORRIENTE	0.00		632,867.68	16,595.89	616,271.79	
51221221003	PRODUCTOS ALIMENTICIOS PARA EL PERSONAL QUE REALIZA LABORES DE CAMPO O SUPERVISION	0.00		514,594.16	16,595.89	487,998.27	
		0.00		173,855.50	0.00	173,855.50	

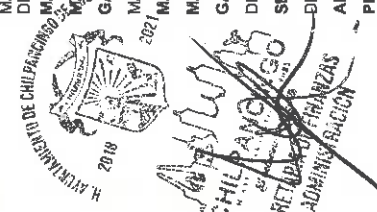

H. Ayuntamiento Municipal Constitucional de Chilpancingo, Gro. SECRETARIA DE FINANZAS Y ADMINISTRACION CONTRALOR MUNICIPAL



H. AYUNTAMIENTO MUNICIPAL DE CHILPANCINGO, GRO.  
SECRETARIA DE FINANZAS Y ADMINISTRACION

CONSOLIDADO



BALANZA DE COMPROBACIÓN DEL 1 DE ENERO AL 31 DE DICIEMBRE DEL 2019

C U E N T A	C O N C E P T O	SALDOS INICIALES		MOVIMIENTOS		SALDOS ACUMULADOS	
		AL 1 DE ENERO DE 2019		ENERO - DICIEMBRE 2019		AL 31 DE DICIEMBRE DE 2019	
		DEBE	HABER	DEBE	HABER	DEBE	HABER
51221221001004	PRODUCTOS ALIMENTICIOS PARA EL PERSONAL EN LAS INSTALACIONES DE LAS DEPENDENCIAS Y ENTIDADES	0.00		306,478.81		16,586.89	289,862.92
51221221001005	PRODUCTOS ALIMENTICIOS PARA LA POBLACION	0.00		34,259.85		0.00	34,259.85
51221221003	SEGURIDAD PUBLICA	0.00		118,273.52		0.00	118,273.52
51221221003003	PRODUCTOS ALIMENTICIOS PARA EL PERSONAL QUE REALIZA LABORES DE CAMPO O SUPERVISION	0.00		118,273.52		0.00	118,273.52
5124	MATERIALES Y ARTICULOS DE CONSTRUCCIÓN Y DE REPARACIÓN	0.00		5,736,513.62		32,184.42	5,704,329.20
51246	MATERIAL ELÉCTRICO Y ELECTRÓNICO	0.00		3,446,466.33		26,535.22	3,419,931.11
51246246	MATERIAL ELECTRICO Y ELECTRONICO	0.00		3,446,466.33		26,535.22	3,419,931.11
51246246001	GASTO CORRIENTE	0.00		846,858.37		16,095.22	830,763.15
51246246001001	MATERIAL ELECTRICO Y ELECTRONICO	0.00		846,858.37		16,095.22	830,763.15
51246246003	SEGURIDAD PUBLICA	0.00		2,599,607.96		10,440.00	2,589,167.96
51246246003001	MATERIAL ELECTRICO Y ELECTRONICO	0.00		2,599,607.96		10,440.00	2,589,167.96
51248	MATERIALES COMPLEMENTARIOS	0.00		21,228.00		0.00	21,228.00
51248248	MATERIALES COMPLEMENTARIOS	0.00		21,228.00		0.00	21,228.00
51248248001	GASTO CORRIENTE	0.00		21,228.00		0.00	21,228.00
51248248001001	MATERIALES COMPLEMENTARIOS	0.00		21,228.00		0.00	21,228.00
51249	OTROS MATERIALES Y ARTICULOS DE CONSTRUCCIÓN Y REPARACIÓN	0.00		2,268,819.29		5,649.20	2,263,170.09
51249249	OTROS MATERIALES Y ARTICULOS DE CONSTRUCCIÓN Y REPARACION	0.00		2,268,819.29		5,649.20	2,263,170.09
51249249001	GASTO CORRIENTE	0.00		2,106,199.28		5,649.20	2,100,550.08
51249249001001	OTROS MATERIALES Y ARTICULOS DE CONSTRUCCIÓN Y REPARACION	0.00		2,106,199.28		5,649.20	2,100,550.08
51249249003	SEGURIDAD PUBLICA	0.00		162,620.01		0.00	162,620.01
51249249003001	OTROS MATERIALES Y ARTICULOS DE CONSTRUCCIÓN Y REPARACION	0.00		162,620.01		0.00	162,620.01
5125	LABORATORIO	0.00		63,011.92		0.00	63,011.92
51252	FERTILIZANTES, PESTICIDAS Y OTROS	0.00		870.01		0.00	870.01
5125252	FERTILIZANTES, PESTICIDAS Y OTROS	0.00		870.01		0.00	870.01
5125252001	GASTO CORRIENTE	0.00		870.01		0.00	870.01
5125252001001	ARBOLES PLANTAS SEMILLAS Y ABONOS	0.00		870.01		0.00	870.01
51253	MEDICINAS Y PRODUCTOS FARMACÉUTICOS	0.00		6,733.10		0.00	6,733.10
51253253	MEDICINAS Y PRODUCTOS FARMACÉUTICOS	0.00		6,733.10		0.00	6,733.10
51253253001	GASTO CORRIENTE	0.00		6,733.10		0.00	6,733.10
51253253001001	MEDICINA Y PRODUCTOS FARMACEUTICOS	0.00		6,733.10		0.00	6,733.10

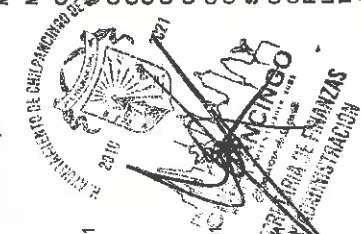

Coram/ Balanza

6.08.08 PM

miércoles 25 marzo 2020

H. Ayuntamiento Municipal de Chilpancingo  
CONTRALORIA INTERNA MUNICIPAL



H. AYUNTAMIENTO MUNICIPAL DE CHILPANCINGO, GRO.

SECRETARIA DE FINANZAS Y ADMINISTRACION

CONSOLIDADO



BALANZA DE COMPROBACIÓN DEL 1 DE ENERO AL 31 DE DICIEMBRE DEL 2019

C U E N T A	C O N C E P T O	SALDOS INICIALES		MOVIMIENTOS		SALDOS ACUMULADOS	
		AL 1 DE ENERO DE 2019		ENERO - DICIEMBRE 2019		AL 31 DE DICIEMBRE DE 2019	
		DEBE	HABER	DEBE	HABER	DEBE	HABER
51254	MATERIALES, ACCESORIOS Y SUMINISTROS	0.00		55,408.81	0.00	55,408.81	
51254254	MATERIALES, ACCESORIOS Y SUMINISTROS MEDICOS.	0.00		55,408.81	0.00	55,408.81	
51254254001	GASTO CORRIENTE	0.00		55,408.81	0.00	55,408.81	
5126	MATERIALES, ACCESORIOS Y SUMINISTROS MEDICOS	0.00		55,408.81	0.00	55,408.81	
51261	COMBUSTIBLES, LUBRICANTES Y ADITIVOS	0.00		24,011,030.45	0.00	24,011,030.45	
51261261	COMBUSTIBLES, LUBRICANTES Y ADITIVOS	0.00		24,011,030.45	0.00	24,011,030.45	
51261261001	GASTO CORRIENTE	0.00		24,011,030.45	0.00	24,011,030.45	
51261261001002	COMBUSTIBLES LUBRICANTES Y ADITIVOS PARA VEHICULOS DESTINADOS A SERVICIOS PUBLICOS	0.00		14,109,669.92	0.00	14,109,669.92	
51261261001004	COMBUSTIBLES, LUBRICANTES Y ADITIVOS A VEHICULOS ASIGNADOS A SERVIDORES PUBLICOS	0.00		12,009,946.11	0.00	12,009,946.11	
51261261003	SEGURIDAD PUBLICA	0.00		2,099,723.81	0.00	2,099,723.81	
51261261003001	COMBUSTIBLES LUBRICANTES Y ADITIVOS DESTINADOS A PROGRAMAS DE SEGURIDAD PUBLICA	0.00		9,901,360.53	0.00	9,901,360.53	
51261261003002	COMBUSTIBLES LUBRICANTES Y ADITIVOS PARA VEHICULOS DESTINADOS A SERVICIOS PUBLICOS	0.00		5,117,603.77	0.00	5,117,603.77	
5127	PROTECCION Y ARTICULOS DEPTIVOS	0.00		4,783,756.76	0.00	4,783,756.76	
51271	VESTUARIO Y UNIFORMES	0.00		4,579,274.66	0.00	4,579,274.66	
51271271	VESTUARIO Y UNIFORMES	0.00		3,718,442.14	0.00	3,718,442.14	
51271271001	GASTO CORRIENTE	0.00		3,718,442.14	0.00	3,718,442.14	
51271271001001	UNIFORMES	0.00		202,628.29	0.00	202,628.29	
51271271003	SEGURIDAD PUBLICA	0.00		202,628.29	0.00	202,628.29	
51271271003001	UNIFORMES	0.00		557,912.85	0.00	557,912.85	
51271271007	FORTASEG	0.00		557,912.85	0.00	557,912.85	
51271271007001	UNIFORMES	0.00		2,957,901.00	0.00	2,957,901.00	
51272	PRENDA DE SEGURIDAD Y PROTECCION PERSONAL	0.00		2,957,901.00	0.00	2,957,901.00	
51272272	PRENDA DE SEGURIDAD Y PROTECCION PERSONAL	0.00		860,832.52	0.00	860,832.52	
51272272001	GASTO CORRIENTE	0.00		860,832.52	0.00	860,832.52	
51272272001001	PRENDA DE SEGURIDAD Y PROTECCION PERSONAL	0.00		525,432.52	0.00	525,432.52	
51272272007	FORTASEG	0.00		525,432.52	0.00	525,432.52	
51272272007001	PRENDA DE SEGURIDAD Y PROTECCION PERSONAL	0.00		335,400.00	0.00	335,400.00	
5128	MATERIALES Y SUMINISTROS PARA SEGURIDAD	0.00		335,400.00	0.00	335,400.00	
		0.00		61,500.00	0.00	61,500.00	

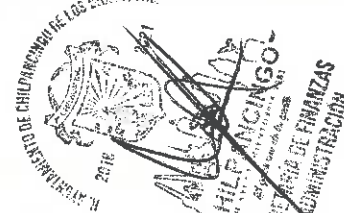





H. AYUNTAMIENTO MUNICIPAL DE CHILPANCINGO, GRO.  
SECRETARIA DE FINANZAS Y ADMINISTRACION  
CONSOLIDADO



BALANZA DE COMPROBACIÓN DEL 1 DE ENERO AL 31 DE DICIEMBRE DEL 2019

C U E N T A	C O N C E P T O	SALDOS INICIALES		MOVIMIENTOS		SALDOS ACUMULADOS	
		AL 1 DE ENERO DE 2019		ENERO - DICIEMBRE 2019		AL 31 DE DICIEMBRE DE 2019	
		DEBE	HABER	DEBE	HABER	DEBE	HABER
51282	MATERIALES DE SEGURIDAD PÚBLICA	0.00		61,500.00	0.00	61,500.00	
51282282	MATERIALES DE SEGURIDAD PÚBLICA.	0.00		61,500.00	0.00	61,500.00	
51282282007	FORTASEG	0.00		61,500.00	0.00	61,500.00	
51282282007001	MATERIALES DE SEGURIDAD PÚBLICA	0.00		61,500.00	0.00	61,500.00	
5129	HERRAMIENTAS, REFACCIONES Y ACCESORIOS MENORES	0.00		816,116.44	180,616.00	635,500.44	
51291	HERRAMIENTAS MENORES	0.00		282,805.93	107,512.80	175,293.13	
51291281	HERRAMIENTAS MENORES	0.00		282,805.93	107,512.80	175,293.13	
51291281001	GASTO CORRIENTE	0.00		222,285.18	90,924.80	131,360.38	
51291281001001	HERRAMIENTAS	0.00		222,285.18	90,924.80	131,360.38	
51291291003	SEGURIDAD PÚBLICA	0.00		60,520.75	16,588.00	43,932.75	
51291291003001	HERRAMIENTAS	0.00		60,520.75	16,588.00	43,932.75	
51292	REFACCIONES Y ACCESORIOS MENORES DE EDIFICIOS	0.00		13,873.88	16,588.00	43,932.75	
51292282	REFACCIONES Y ACCESORIOS MENORES DE EDIFICIOS.	0.00		13,873.88	0.00	13,873.88	
51292282001	GASTO CORRIENTE	0.00		13,873.88	0.00	13,873.88	
51292282001001	REFACCIONES Y ACCESORIOS MENORES DE EDIFICIOS	0.00		13,873.88	0.00	13,873.88	
51294	EQUIPO DE CÓMPUTO Y TECNOLOGÍAS DE LA INFORMACIÓN	0.00		21,010.65	0.00	21,010.65	
51294284	EQUIPO DE CÓMPUTO Y TECNOLOGÍAS DE LA INFORMACION	0.00		21,010.65	0.00	21,010.65	
51294284001	GASTO CORRIENTE	0.00		21,010.65	0.00	21,010.65	
51294284001001	REFACCIONES Y ACCESORIOS MENORES DE EQUIPO DE COMPUTO	0.00		21,010.65	0.00	21,010.65	
51296	EQUIPO DE TRANSPORTE	0.00		414,840.87	58,371.20	356,469.67	
51296286	REFACCIONES Y ACCESORIOS MENORES DE EQUIPO DE TRANSPORTE	0.00		414,840.87	58,371.20	356,469.67	
51296286001	GASTO CORRIENTE	0.00		414,840.87	58,371.20	356,469.67	
51296286001001	REFACCIONES DE EQUIPO DE TRANSPORTE	0.00		414,840.87	58,371.20	356,469.67	
51298	REFACCIONES Y ACCESORIOS MENORES DE MAQUINARIA Y OTROS EQUIPOS	0.00		17,460.69	0.00	17,460.69	
51298288	REFACCIONES Y ACCESORIOS MENORES DE MAQUINARIA Y OTROS EQUIPOS	0.00		17,460.69	0.00	17,460.69	
51298288001	GASTO CORRIENTE	0.00		17,460.69	0.00	17,460.69	
51298288001001	REFACCIONES, ACCESORIOS MENORES DE MAQUINARIA Y OTROS EQUIPOS	0.00		17,460.69	0.00	17,460.69	
51299	BIENES MUEBLES	0.00		66,124.42	14,732.00	51,392.42	
51299289	BIENES MUEBLES.	0.00		66,124.42	14,732.00	51,392.42	



H. Ayuntamiento Municipal de Chilpancingo, Gro.  
CONTRALORIA MUNICIPAL





H. AYUNTAMIENTO MUNICIPAL DE CHILPANCINGO, GRO.  
SECRETARIA DE FINANZAS Y ADMINISTRACION  
CONSOLIDADO



BALANZA DE COMPROBACIÓN DEL 1 DE ENERO AL 31 DE DICIEMBRE DEL 2019

C U E N T A	C O N C E P T O	SALDOS INICIALES		MOVIMIENTOS		SALDOS ACUMULADOS	
		AL 1 DE ENERO DE 2019		ENERO - DICIEMBRE 2019		AL 31 DE DICIEMBRE DE 2019	
		DEBE	HABER	DEBE	HABER	DEBE	HABER
51299299001	GASTO CORRIENTE	0.00		66,124.42	14,732.00	51,392.42	
51299299001001	REFACCIONES Y ACCESORIOS MENORES, OTROS BIENES MUEBLES	0.00		66,124.42	14,732.00	51,392.42	
513	SERVICIOS GENERALES	0.00		115,491,358.44	8,311,981.19	107,179,377.25	
5131	SERVICIOS BÁSICOS	0.00		19,066,783.11	3,778,705.72	15,288,077.39	
51311	ENERGÍA ELÉCTRICA	0.00		9,979,592.03	3,778,705.72	6,200,886.31	
513111	ENERGÍA ELÉCTRICA.	0.00		9,979,592.03	3,778,705.72	6,200,886.31	
51311311	GASTO CORRIENTE	0.00		1,378,442.53	18,401.00	1,360,041.53	
51311311001	SERVICIO DE ENERGIA ELECTRICA	0.00		1,378,442.53	18,401.00	1,360,041.53	
51311311003	SEGURIDAD PUBLICA	0.00		8,601,149.50	3,760,304.72	4,840,844.78	
51311311003001	SERVICIO DE ENERGIA ELECTRICA	0.00		4,149,128.52	3,760,304.72	388,823.80	
51311311003002	PAGO DE DERECHO DE ALUMBRADO PUBLICO DAP	0.00		4,452,020.98	0.00	4,452,020.98	
51313	AGUA	0.00		8,959,928.03	0.00	8,959,928.03	
51313313	AGUA	0.00		8,959,928.03	0.00	8,959,928.03	
51313313001	GASTO CORRIENTE	0.00		4,675,584.44	0.00	4,675,584.44	
51313313001001	AGUA POTABLE	0.00		4,675,584.44	0.00	4,675,584.44	
51313313003	SEGURIDAD PUBLICA	0.00		4,284,343.59	0.00	4,284,343.59	
51313313003001	AGUA POTABLE	0.00		4,284,343.59	0.00	4,284,343.59	
51314	TELEFONIA TRADICIONAL	0.00		56,592.55	0.00	56,592.55	
51314314	TELEFONIA TRADICIONAL	0.00		56,592.55	0.00	56,592.55	
51314314001	GASTO CORRIENTE	0.00		24,356.23	0.00	24,356.23	
51314314001001	TELEFONOS	0.00		24,356.23	0.00	24,356.23	
51314314003	SEGURIDAD PUBLICA	0.00		32,236.32	0.00	32,236.32	
51314314003001	TELEFONOS	0.00		32,236.32	0.00	32,236.32	
51315	TELEFONIA CELULAR	0.00		492.11	0.00	492.11	
51315315	TELEFONIA CELULAR	0.00		492.11	0.00	492.11	
51315315001	GASTO CORRIENTE	0.00		492.11	0.00	492.11	
51315315001001	TELEFONIA CELULAR	0.00		492.11	0.00	492.11	
51317	SERVICIOS DE ACCESO DE INTERNET, REDES Y PROCESAMIENTO DE INFORMACION	0.00		69,478.79	0.00	69,478.79	
51317317	SERVICIOS DE ACCESO DE INTERNET, REDES Y PROCESAMIENTO DE INFORMACION	0.00		69,478.79	0.00	69,478.79	
51317317001	GASTO CORRIENTE	0.00		69,478.79	0.00	69,478.79	
51317317001001	SERVICIO DE ACCESO A INTERNET REDES Y PROCESAMIENTO DE INFORMACION	0.00		69,478.79	0.00	69,478.79	
51318	SERVICIOS POSTALES Y TELEGRAFICOS	0.00		699.60	0.00	699.60	

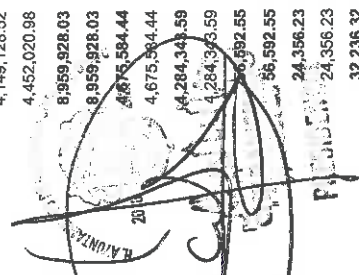



H. AYUNTAMIENTO MUNICIPAL DE CHILPANCINGO, GRO.

SECRETARIA DE FINANZAS Y ADMINISTRACION

CONSOLIDADO



BALANZA DE COMPROBACION DEL 1 DE ENERO AL 31 DE DICIEMBRE DEL 2019

C U E N T A	C O N C E P T O	SALDOS INICIALES		MOVIMIENTOS		SALDOS ACUMULADOS	
		AL 1 DE ENERO DE 2019		ENERO - DICIEMBRE 2019		AL 31 DE DICIEMBRE DE 2019	
		DEBE	HABER	DEBE	HABER	DEBE	HABER
51318318	SERVICIOS POSTALES Y TELEGRAFICOS	0.00		699.60	0.00	699.60	
51318318001	GASTO CORRIENTE	0.00		699.60	0.00	699.60	
51318318001001	SERVICIO POSTAL	0.00		699.60	0.00	699.60	
5132	SERVICIOS DE ARRENDAMIENTO	0.00		42,723,019.48	3,389,141.52	39,333,877.96	
51322	ARRENDAMIENTO DE EDIFICIOS	0.00		1,563,612.00	0.00	1,563,612.00	
51322322	ARRENDAMIENTO DE EDIFICIOS	0.00		1,563,612.00	0.00	1,563,612.00	
51322322001	GASTO CORRIENTE	0.00		293,412.00	0.00	293,412.00	
51322322001001	ARRENDAMIENTO DE EDIFICIOS	0.00		293,412.00	0.00	293,412.00	
51322322003	SEGURIDAD PUBLICA	0.00		1,270,200.00	0.00	1,270,200.00	
51322322003002	ARRENDAMIENTO DE TERRENO (BASUREO MUNICIPAL)	0.00		1,270,200.00	0.00	1,270,200.00	
51323	ARRENDAMIENTO DE MOBILIARIO Y EQUIPO DE ADMINISTRACION, EDUCACIONAL Y RECREATIVO	0.00		1,622,333.90	125,377.51	1,496,956.39	
51323323	GASTO CORRIENTE	0.00		1,622,333.90	125,377.51	1,496,956.39	
51323323001	ARRENDAMIENTO DE EQUIPO Y BIENES INFORMATICOS	0.00		1,415,762.89	125,377.51	1,290,385.38	
51323323001001	ARRENDAMIENTO DE MOBILIARIO	0.00		1,370,438.89	125,377.51	1,245,061.38	
51323323002	SEGURIDAD PUBLICA	0.00		46,324.00	0.00	46,324.00	
51323323003	ARRENDAMIENTO DE EQUIPO Y BIENES INFORMATICOS	0.00		206,571.01	0.00	206,571.01	
51325	ARRENDAMIENTO DE EQUIPO DE TRANSPORTE	0.00		35,618,644.04	3,027,020.00	32,591,624.04	
51325325	GASTO CORRIENTE	0.00		35,618,644.04	3,027,020.00	32,591,624.04	
51325325001	ARRENDAMIENTO DE VEHICULOS TERRESTRES PARA SERVICIOS PUBLICOS Y LA OPERACION DE PROGRAMAS PUBLICOS	0.00		5,534,463.34	0.00	5,534,463.34	
51325325001002	ARRENDAMIENTO DE VEHICULOS TERRESTRES PARA SERVIDORES PUBLICOS	0.00		5,441,663.34	0.00	5,441,663.34	
51325325001005	OBRA PUBLICA	0.00		92,800.00	0.00	92,800.00	
51325325002	ARRENDAMIENTO DE VEHICULOS PARA LA VERIFICACION Y EL SEGUIMIENTO DE LAS OBRAS DEL FAISM.	0.00		4,106,400.00	0.00	4,106,400.00	
51325325002003	SEGURIDAD PUBLICA	0.00		4,106,400.00	0.00	4,106,400.00	
51325325003	EJECUCION DE PROGRAMAS DE SEGURIDAD PUBLICA	0.00		25,977,780.70	3,027,020.00	22,950,760.70	
51325325003001	ARRENDAMIENTO DE VEHICULOS PARA LA EJECUCION DE PROGRAMAS DE SEGURIDAD PUBLICA	0.00		1,971,734.80	0.00	1,971,734.80	
51325325003004	ARRENDAMIENTO DE VEHICULOS PARA TRASLADO DE RESIDUOS SOLIDOS	0.00		10,088,951.80	3,027,020.00	7,041,931.80	
51325325003005	ARRENDAMIENTO DE MAQUINARIA PARA SANEAMIENTO DE BASURERO MUNICIPAL	0.00		12,565,031.95	0.00	12,565,031.95	
51325325003006	ARRENDAMIENTO DE MAQUINARIA Y EQUIPO	0.00		1,372,062.15	0.00	1,372,062.15	

*[Handwritten signature]*

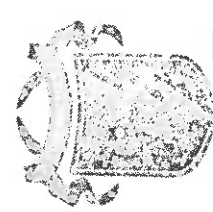

Coram/ Balanza

6.08.08 PM

miércoles 25 marzo 2020

H. Ayuntamiento Municipal de Chilpancingo, Gro.  
SECRETARIA DE FINANZAS Y ADMINISTRACION  
CONTRALORIA



H. AYUNTAMIENTO MUNICIPAL DE CHILPANCINGO, GRO.  
SECRETARIA DE FINANZAS Y ADMINISTRACION  
CONSOLIDADO



BALANZA DE COMPROBACIÓN DEL 1 DE ENERO AL 31 DE DICIEMBRE DEL 2019

C U E N T A	C O N C E P T O	SALDOS INICIALES		MOVIMIENTOS		SALDOS ACUMULADOS	
		AL 1 DE ENERO DE 2019		ENERO - DICIEMBRE 2019		AL 31 DE DICIEMBRE DE 2019	
		DEBE	HABER	DEBE	HABER	DEBE	HABER
	PARA SANEAMIENTO						
51326	ARRENDAMIENTO DE MAQUINARIA, OTROS EQUIPOS Y HERRAMIENTAS	0.00		3,918,429.54	236,744.01	3,681,685.53	
51326326	ARRENDAMIENTO DE MAQUINARIA, OTROS EQUIPOS Y HERRAMIENTAS	0.00		3,918,429.54	236,744.01	3,681,685.53	
51326326001	GASTO CORRIENTE	0.00		3,256,661.53	0.00	3,256,661.53	
51326326003	ARRENDAMIENTO DE MAQUINARIA Y EQUIPO	0.00		3,256,661.53	0.00	3,256,661.53	
51326326003001	SEGURIDAD PUBLICA	0.00		661,768.01	236,744.01	425,024.00	
5133	ARRENDAMIENTO DE MAQUINARIA Y EQUIPO	0.00		661,768.01	236,744.01	425,024.00	
51331	SERVICIOS PROFESIONALES, CIENTIFICOS Y TECNICOS Y OTROS SERVICIOS	0.00		28,683,234.37	842,897.76	27,840,336.61	
51331331	SERVICIOS LEGALES, DE CONTABILIDAD, AUDITORIA Y RELACIONADOS	0.00		7,567,771.64	0.00	7,567,771.64	
51331331001	SERVICIOS LEGALES, DE CONTABILIDAD AUDITORIA Y RELACIONADOS	0.00		7,567,771.64	0.00	7,567,771.64	
51331331001004	GASTO CORRIENTE	0.00		5,304,271.64	0.00	5,304,271.64	
51331331001004004	OTRAS ASESORIAS PARA LA OPERACION DE PROGRAMAS	0.00		5,304,271.64	0.00	5,304,271.64	
51331331003	SEGURIDAD PUBLICA	0.00		3,500.00	0.00	3,500.00	
51331331003001	OTRAS ASESORIAS PARA LA OPERACION DE PROGRAMAS	0.00		3,500.00	0.00	3,500.00	
51331331040	INGRESOS PROPIOS	0.00		2,260,000.00	0.00	2,260,000.00	
51331331040026	EJERCICIO 2019	0.00		2,260,000.00	0.00	2,260,000.00	
51331331040026004	ESTUDIO PARA LA MODERNIZACION DEL SISTEMA CATASTRAL DEL H. AYUNTAMIENTO DE CHILPANCINGO A TRAVES DEL USO DE NUEVAS TECNOLOGIAS DE LA INFORMACION Y COMUNICACION, SEGUN CONTRATO DE FECHA 29 DE ABRIL DE 2019	0.00		92,800.00	0.00	92,800.00	
51331331040026004004	DISEÑO Y ELABORACION DE UN PLAN DE ADECUACION, RACIONALIDAD Y DISCIPLINA DEL GASTO PUBLICO 2019-2021	0.00		127,600.00	0.00	127,600.00	
51331331040026004004003	MATERIA DE ADQUISICIONES ENAJENACIONES, ARRENDAMIENTOS Y PRESTACION DE SERVICIOS, SEGUN CONTRATO DE PRESTACION DE SERVICIOS DE FECHA 28 DE OCTUBRE 2019	0.00		1,680,000.00	0.00	1,680,000.00	
51331331040026004004003003	ELABORACION DE ANTECEDENTES Y DIAGNOSTICO PRONOSTICO PARA EL ESTUDIO DEL MUNICIPIO DE CHILPANCINGO DE LOS BRAVOS	0.00		3,997,085.60	840,396.80	3,156,688.80	
51332	SERVICIOS DE DISEÑO, ARQUITECTURA, INGENIERIA Y ACTIVIDADES RELACIONADAS	0.00		3,997,085.60	840,396.80	3,156,688.80	
51332332	SERVICIOS DE DISEÑO, ARQUITECTURA, INGENIERIA Y ACTIVIDADES RELACIONADAS	0.00		3,997,085.60	840,396.80	3,156,688.80	
51332332001	GASTO CORRIENTE	0.00		2,300.00	0.00	2,300.00	

Escudo Nacional de Chile  
AYUNTAMIENTO MUNICIPAL DE CHILPANCINGO, GRO.  
SECRETARIA DE FINANZAS Y ADMINISTRACION  
6 MARZO 2020

Escudo Municipal de Chilpancingo  
AYUNTAMIENTO MUNICIPAL DE CHILPANCINGO, GRO.  
SECRETARIA DE FINANZAS Y ADMINISTRACION  
6 MARZO 2020



H. AYUNTAMIENTO MUNICIPAL DE CHILPANCINGO, GRO.  
SECRETARIA DE FINANZAS Y ADMINISTRACION  
CONSOLIDADO



BALANZA DE COMPROBACION DEL 1 DE ENERO AL 31 DE DICIEMBRE DEL 2019

C U E N T A	C O N C E P T O	SALDOS INICIALES		MOVIMIENTOS		SALDOS ACUMULADOS	
		AL 1 DE ENERO DE 2019		ENERO - DICIEMBRE 2019		AL 31 DE DICIEMBRE DE 2019	
		DEBE	HABER	DEBE	HABER	DEBE	HABER
51332332001001	SERVICIOS DE DISEÑO, ARQUITECTURA, INGENIERIA Y ACTIVIDADES RELACIONADAS.	0.00		2,300.00	0.00	2,300.00	
51332332001002	ELABORACION DE MURALES ARTISTICOS	0.00		2,300.00	0.00	2,300.00	
51332332002	FONDO DE APORTACION PARA LA INFRAESTRUCTURA SOCIAL MUNICIPAL	0.00		2,288,992.00	0.00	2,288,992.00	
51332332002001	OBRA PUBLICA	0.00		2,288,992.00	0.00	2,288,992.00	
51332332002001001	SERVICIOS DE DISEÑO, ARQUITECTURA, INGENIERIA Y ACTIVIDADES RELACIONADAS.	0.00		882,992.00	0.00	882,992.00	
51332332002001003	ELABORACION DE PROYECTOS EJECUTIVOS DE INFRAESTRUCTURA	0.00		882,992.00	0.00	882,992.00	
51332332002001003026	EJERCICIO 2019	0.00		882,992.00	0.00	882,992.00	
51332332002001003026001	ELABORACION DE ESTUDIOS DE MECANICA DE SUELOS PARA EL PROYECTO DE LA REHABILITACION DEL CANAL DE LA BARRANCA APATZINGO, UBICADO EN LA COL. CENTRO DE CHILPANCINGO DE LOS BRAVO, ESTADO DE GUERRERO.	0.00		882,992.00	0.00	882,992.00	
51332332002001003026001003	ELABORACION DE PROYECTOS EJECUTIVOS DE INFRAESTRUCTURA	0.00		1,406,000.00	0.00	1,406,000.00	
51332332002001003026001003026	EJERCICIO 2019	0.00		1,406,000.00	0.00	1,406,000.00	
51332332002001003026001003026003	ELABORACION DE MANUALES DE ORGANIZACION Y PROCEDIMIENTOS (PRODIM)	0.00		1,406,000.00	0.00	1,406,000.00	
51332332003	SEGURIDAD PUBLICA	0.00		1,705,793.60	840,396.80	865,396.80	
51332332003001	SERVICIOS DE DISEÑO, ARQUITECTURA, INGENIERIA Y ACTIVIDADES RELACIONADAS.	0.00		1,705,793.60	840,396.80	865,396.80	
51332332003001026	EJERCICIO 2019	0.00		1,705,793.60	840,396.80	865,396.80	
51332332003001026003	ELABORACION DE ESTUDIOS PARA LE CUMPLIMIENTO DE LOS REQUISITOS DE LA NORMA 083 DE SEMANAT PARA EL PROYECTO DEL RELLENO SANITARIO DENOMINADO "EL HUITECO" UBICADO EN EL KM 4.5 DE LA CARRETERA LIBRAMIENTO CHILPANCINGO-TIXTLA	0.00		1,680,793.60	840,396.80	840,396.80	
51332332003001026003026	ELABORACION DE PROYECTO ELECTRICO EN MEDIA TENSION DE ACUERDO A NORMAS VIGENTES DE CFE	0.00		25,000.00	0.00	25,000.00	
51333	SERVICIOS DE CONSULTORIA ADMINISTRATIVA, PROCESOS, TECNICA Y EN TECNOLOGIAS DE LA INFORMACION	0.00		13,256,083.18	0.00	13,256,083.18	
51333333	SERVICIOS DE CONSULTORIA ADMINISTRATIVA, PROCESOS TECNICA Y EN TECNOLOGIAS DE LA INFORMACION	0.00		264,675.19	0.00	264,675.19	
51333333001	GASTO CORRIENTE	0.00		264,675.19	0.00	264,675.19	
51333333001001	SERVICIOS DE INFORMATICA	0.00		8,895.00	0.00	8,895.00	
51333333001003	SERVICIOS RELACIONADOS CON LA CERTIFICACION DE PROCESOS	0.00		255,780.19	0.00	255,780.19	
51333339	SERVICIOS PROFESIONALES CIENTIFICOS Y TECNICOS INTEGRALES	0.00		12,991,407.99	0.00	12,991,407.99	

Stamp: H. AYUNTAMIENTO MUNICIPAL DE CHILPANCINGO, GRO. SECRETARIA DE FINANZAS Y ADMINISTRACION. Includes a large signature and official seal.





H. AYUNTAMIENTO MUNICIPAL DE CHILPANCINGO, GRO.

SECRETARIA DE FINANZAS Y ADMINISTRACION

CONSOLIDADO



BALANZA DE COMPROBACION DEL 1 DE ENERO AL 31 DE DICIEMBRE DEL 2019

C U E N T A	C O N C E P T O	SALDOS INICIALES		MOVIMIENTOS		SALDOS ACUMULADOS	
		AL 1 DE ENERO DE 2019		ENERO - DICIEMBRE 2019		AL 31 DE DICIEMBRE DE 2019	
		DEBE	HABER	DEBE	HABER	DEBE	HABER
5133339007	FORTASEG	0.00		12,991,407.99	0.00	12,991,407.99	
5133339007001	PREVENCIÓN SOCIAL DE LA VIOLENCIA Y LA DELINCUENCIA CON PARTICIPACIÓN CIUDADANA EJERCICIO 2019	0.00		5,182,995.29	0.00	5,182,995.29	
5133339007001026	PREVENCIÓN DE VIOLENCIA ESCOLAR (Proyecto)	0.00		5,182,995.29	0.00	5,182,995.29	
5133339007001026001	JOVENES CONSTRUYENDO PREVENCIÓN (Seguimiento y Evaluación)	0.00		1,350,000.00	0.00	1,350,000.00	
5133339007001026002	PREVENCIÓN DE VIOLENCIA ESCOLAR (Seguimiento y Evaluación)	0.00		68,299.53	0.00	68,299.53	
5133339007001026003	JOVENES CONSTRUYENDO PREVENCIÓN (Proyecto)	0.00		150,000.00	0.00	150,000.00	
5133339007001026004	PREVENCIÓN DE VIOLENCIA FAMILIAR Y DE GENERO (Proyecto)	0.00		614,695.76	0.00	614,695.76	
5133339007001026006	PREVENCIÓN DE VIOLENCIA FAMILIAR Y DE GENERO (Seguimiento y Evaluación)	0.00		2,700,000.00	0.00	2,700,000.00	
5133339007001026006	DESARROLLO, PROFESIONALIZACIÓN Y CERTIFICACIÓN POLICIAL	0.00		300,000.00	0.00	300,000.00	
5133339007002	CERTIFICACIÓN POLICIAL	0.00		642,500.00	0.00	642,500.00	
5133339007002026	EJERCICIO 2019	0.00		642,500.00	0.00	642,500.00	
5133339007002026001	3. PRUEBAS PARA LICENCIA OFICIAL COLECTIVA PSICOLÓGICA, MÉDICA Y TOXICOLÓGICA)	0.00		25,000.00	0.00	25,000.00	
5133339007002026002	EVALUACIONES DE PERSONAL EN ACTIVOS (PERMANENCIAS, ASCENSOS Y PROMOCIONES)	0.00		286,000.00	0.00	286,000.00	
5133339007002026003	EVALUACIONES DE NUEVO INGRESO	0.00		331,500.00	0.00	331,500.00	
5133339007003	SISTEMAS DE VIDEOVIGILANCIA	0.00		7,165,912.70	0.00	7,165,912.70	
5133339007003026	EJERCICIO 2019	0.00		7,165,912.70	0.00	7,165,912.70	
5133339007003026001	SERVICIOS INTEGRALES DE TELECOMUNICACIONES	0.00		7,165,912.70	0.00	7,165,912.70	
51334	SERVICIOS DE CAPACITACIÓN	0.00		1,350,795.40	0.00	1,350,795.40	
51334334	SERVICIOS DE CAPACITACIÓN	0.00		1,350,795.40	0.00	1,350,795.40	
51334334001	GASTO CORRIENTE	0.00		128,184.00	0.00	128,184.00	
51334334001001	SERVICIOS DE CAPACITACIÓN A SERVIDORES PUBLICOS	0.00		128,184.00	0.00	128,184.00	
51334334003	SEGURIDAD PUBLICA	0.00		27,000.00	0.00	27,000.00	
51334334003004	SERVICIOS DE CAPACITACIÓN A SERVIDORES PUBLICOS	0.00		27,000.00	0.00	27,000.00	
51334334003001003	BECAS PARA ASPIRANTES A POLICIAS (CAPACITACION)	0.00		27,000.00	0.00	27,000.00	
51334334007	FORTASEG	0.00		1,195,611.40	0.00	1,195,611.40	
51334334007005	GASTOS DE OPERACION (COPARTICIPACION)	0.00		1,011.40	0.00	1,011.40	
51334334007005001	VIATICOS (COPARTICIPACION)	0.00		1,011.40	0.00	1,011.40	
51334334007020	DESARROLLO Y PROFESIONALIZACIÓN Y CERTIFICACION POLICIAL	0.00		1,194,600.00	0.00	1,194,600.00	
51334334007020026	EJERCICIO 2019	0.00		1,194,600.00	0.00	1,194,600.00	
51334334007020026001	COMPETENCIAS BASICAS DE LA FUNCION POLICIAL	0.00		86,100.00	0.00	86,100.00	

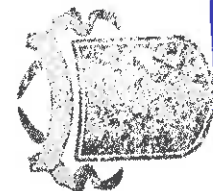
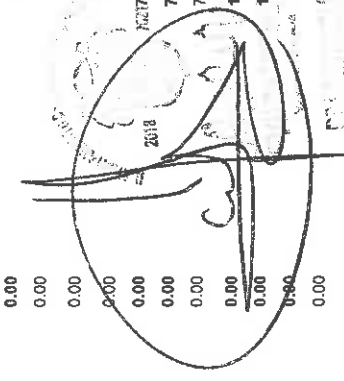

El Ayuntamiento Municipal de Chilpancingo, Gro. Continúa en la Hoja 164 de 195

miércoles 25 marzo 2020

6.08.08 PM

Coram/ Balanza





H. AYUNTAMIENTO MUNICIPAL DE CHILPANCINGO, GRO.

SECRETARIA DE FINANZAS Y ADMINISTRACION

CONSOLIDADO



BALANZA DE COMPROBACIÓN DEL 1 DE ENERO AL 31 DE DICIEMBRE DEL 2019

C U E N T A	C O N C E P T O	SALDOS INICIALES		MOVIMIENTOS		SALDOS ACUMULADOS	
		AL 1 DE ENERO DE 2019		ENERO - DICIEMBRE 2019		AL 31 DE DICIEMBRE DE 2019	
		DEBE	HABER	DEBE	HABER	DEBE	HABER
5133433400702026002	COMPETENCIAS BASICAS DE LA FUNCION POLICIAL	0.00		430,500.00	0.00	430,500.00	
5133433400702026003	MEDIACION	0.00		140,000.00	0.00	140,000.00	
5133433400702026004	USO LEGITIMO DE LA FUERZA	0.00		70,000.00	0.00	70,000.00	
5133433400702026005	LA POLICIA Y SU ACTUACION ANTE LA VICTIMA EN EL SISTEMA DE JUSTICIA PENAL (40 HORAS)	0.00		140,000.00	0.00	140,000.00	
5133433400702026006	FORMACION INICIAL (ASPIRANTES)	0.00		200,000.00	0.00	200,000.00	
5133433400702026007	ANALISIS CRIMINAL DE PRODUCTOS DE INVESTIGACION	0.00		70,000.00	0.00	70,000.00	
5133433400702026008	EQUIDAD DE GENERO	0.00		35,000.00	0.00	35,000.00	
5133433400702026009	FOMACION INICIAL (ELEMENTOS EN ACTIVO)	0.00		23,000.00	0.00	23,000.00	
51336	SERVICIOS DE APOYO ADMINISTRATIVO, TRADUCCION, FOTOCOPIADO E IMPRESION	0.00		2,511,498.55	2,508.96	2,508,989.59	
51336336	SERVICIOS DE APOYO ADMINISTRATIVO, TRADUCCION, FOTOCOPIADO E IMPRESION	0.00		2,511,498.55	2,508.96	2,508,989.59	
51336336001	GASTO CORRIENTE	0.00		2,295,842.00	2,508.96	2,298,350.96	
51336336001003	IMPRESION DE DOCUMENTOS OFICIALES PARA LA PRESTACION DE SERVICIOS PUBLICOS, IDENTIFICACION, FORMATOS ADMINISTRATIVOS Y FISCALES, FORMAS VALORADAS, CERTIFICADOS Y TITULOS, IMPRESION Y ELABORACION DE MATERIAL INFORMATIVO DERIVADO DE LA OPERACION Y ADMINISTRACION DE LAS DEPENDENCIAS Y ENTIDADES	0.00		330,889.16	2,508.96	328,388.20	
51336336001004	SEGURIDAD PUBLICA	0.00		1,964,952.84	0.00	1,964,952.84	
51336336003	OTROS SERVICIOS COMERCIALES	0.00		1,656.55	0.00	1,656.55	
51336336003001	IMPRESION DE DOCUMENTOS OFICIALES PARA LA PRESTACION DE SERVICIOS PUBLICOS, IDENTIFICACION, FORMATOS ADMINISTRATIVOS Y FISCALES, FORMAS VALORADAS, CERTIFICADOS Y TITULOS.	0.00		67,145.99	0.00	67,145.99	
51336336003002	FORTASEG	0.00		143,510.56	0.00	143,510.56	
51336336007	EJERCICIO 2019	0.00		5,000.00	0.00	5,000.00	
51336336007020	DIFUSION INTERNA DE LA CONVOCATORIA PARA PROMOCION PARA POLICIA MUNICIPAL COMERCIALES	0.00		5,000.00	0.00	5,000.00	
5134	SERVICIOS FINANCIEROS Y BANCARIOS	0.00		288,934.13	535.91	289,470.04	
51341	SERVICIOS FINANCIEROS Y BANCARIOS	0.00		237,430.13	535.91	237,966.04	
51341341	GASTO CORRIENTE	0.00		237,430.13	535.91	237,966.04	
51341341001	SERVICIOS FINANCIEROS Y BANCARIOS	0.00		211,696.53	482.48	212,179.01	
51341341001001	INTERESES POR PRESTAMOS ENTRE PROGRAMAS	0.00		211,217.43	482.48	211,700.00	
51341341001004	OBRA PUBLICA	0.00		479.10	0.00	479.10	
51341341002		0.00		502.18	0.00	502.18	

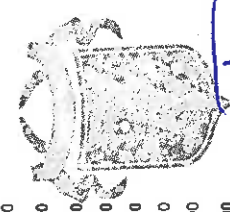
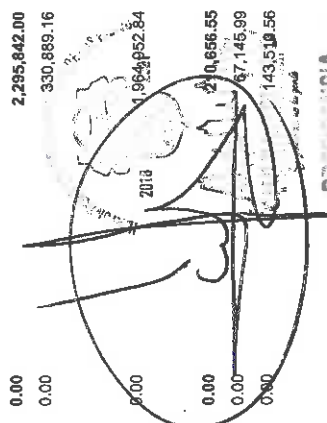



H. AYUNTAMIENTO MUNICIPAL DE CHILPANCINGO, GRO.

SECRETARIA DE FINANZAS Y ADMINISTRACION

CONSOLIDADO



BALANZA DE COMPROBACION DEL 1 DE ENERO AL 31 DE DICIEMBRE DEL 2019

C U E N T A	C O N C E P T O	SALDOS INICIALES		MOVIMIENTOS		SALDOS ACUMULADOS	
		AL 1 DE ENERO DE 2019		ENERO - DICIEMBRE 2019		AL 31 DE DICIEMBRE DE 2019	
		DEBE	HABER	DEBE	HABER	DEBE	HABER
51341341002004	SERVICIOS FINANCIEROS Y BANCARIOS	0.00		502.18		0.00	502.18
51341341003	SEGURIDAD PUBLICA	0.00		24,653.74		53.43	24,600.31
51341341003001	SERVICIOS FINANCIEROS Y BANCARIOS	0.00		24,653.74		53.43	24,600.31
51341341007	FORTASEG	0.00				0.00	577.68
51341341007001	SERVICIOS FINANCIEROS Y BANCARIOS	0.00		577.68		0.00	577.68
51347	FLETES Y MANIOBRAS	0.00		51,504.00		0.00	51,504.00
51347347	FLETES Y MANIOBRAS.	0.00		51,504.00		0.00	51,504.00
51347347001	FLETES Y MANIOBRAS	0.00		51,504.00		0.00	51,504.00
5135	GASTO CORRIENTE	0.00		51,504.00		0.00	51,504.00
51351	SERVICIOS DE INSTALACION, REPARACION, MANTENIMIENTO Y CONSERVACION DE INMUEBLES	0.00		6,698,407.18	92,747.22	0.00	6,605,659.96
51351351	CONSERVACION Y MANTENIMIENTO MENOR DE INMUEBLES	0.00		3,303,188.97		0.00	3,303,188.97
51351351001	GASTO CORRIENTE	0.00		3,303,188.97		0.00	3,303,188.97
51351351001001	MANTENIMIENTO Y CONSERVACION DE INMUEBLES PARA LA PRESTACION DE SERVICIOS ADMINISTRATIVOS	0.00		3,303,188.97		0.00	3,303,188.97
51351351001002	MANTENIMIENTO Y CONSERVACION DE INMUEBLES PARA LA PRESTACION DE SERVICIOS PUBLICOS	0.00		694,931.40		0.00	534,331.40
51351351001003	MANTENIMIENTO Y CONSERVACION DE ESPACIOS PUBLICOS	0.00		866,046.96		0.00	866,046.96
51352	INSTALACION, REPARACION Y MANTENIMIENTO DE MOBILIARIO Y EQUIPO DE ADMINISTRACION, EDUCACIONAL Y RECREATIVO	0.00		1,902,210.61		0.00	1,902,210.61
51352352	INSTALACION, REPARACION Y MANTENIMIENTO DE MOBILIARIO Y EQUIPO DE ADMINISTRACION, EDUCACIONAL Y ECREATIVO	0.00		7,694.00		0.00	7,694.00
51352352001	GASTO CORRIENTE	0.00		7,694.00		0.00	7,694.00
51352352001001	INSTALACION, REPARACION Y MANTENIMIENTO DE MOBILIARIO DE EQUIPO DE ADMINISTRACION	0.00		7,694.00		0.00	7,694.00
51353	INFORMACION	0.00		157,103.72		0.00	157,103.72
51353353	INSTALACION, REPARACION Y MANTENIMIENTO DE EQUIPO DE COMPUTO Y TECNOLOGIA DE LA INFORMACION	0.00		157,103.72		0.00	157,103.72
51353353001	GASTO CORRIENTE	0.00		69,098.00		0.00	69,098.00
51353353001001	MANTENIMIENTO Y CONSERVACION DE BIENES INFORMATICOS	0.00		69,098.00		0.00	69,098.00
51353353003	SEGURIDAD PUBLICA	0.00		88,005.72		0.00	88,005.72
51353353003001	MANTENIMIENTO Y CONSERVACION DE BIENES INFORMATICOS	0.00		88,005.72		0.00	88,005.72

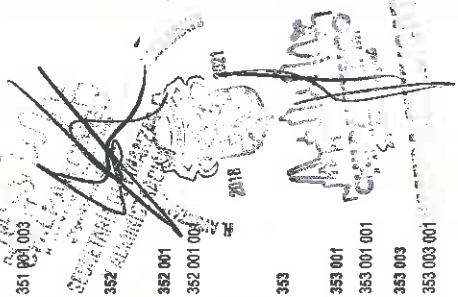

H. Ayuntamiento Municipal de Chilpancingo, Gro. Contraloría Municipal



H. AYUNTAMIENTO MUNICIPAL DE CHILPANCINGO, GRO.

SECRETARIA DE FINANZAS Y ADMINISTRACION

CONSOLIDADO



BALANZA DE COMPROBACIÓN DEL 1 DE ENERO AL 31 DE DICIEMBRE DEL 2019

C U E N T A	C O N C E P T O	SALDOS INICIALES		MOVIMIENTOS		SALDOS ACUMULADOS	
		AL 1 DE ENERO DE 2019		ENERO - DICIEMBRE 2019		AL 31 DE DICIEMBRE DE 2019	
		DEBE	HABER	DEBE	HABER	DEBE	HABER
51354	INSTALACIÓN, REPARACIÓN Y MANTENIMIENTO DE EQUIPO E INSTRUMENTAL MÉDICO Y DE LABORATORIO	0.00		53,708.00	26,680.00	53,708.00	27,028.00
51354354	INSTALACIÓN, REPARACIÓN Y MANTENIMIENTO DE EQUIPO E INSTRUMENTAL MÉDICO Y DE LABORATORIO	0.00		53,708.00	26,680.00	53,708.00	27,028.00
51354354003	SEGURIDAD PÚBLICA	0.00		53,708.00	26,680.00	53,708.00	27,028.00
51354354003001	MANTO Y REPARACIÓN DE SEMAFOROS VIALES	0.00		53,708.00	26,680.00	53,708.00	27,028.00
51355	REPARACIÓN Y MANTENIMIENTO DE EQUIPO DE TRANSPORTE	0.00		2,345,803.11	66,067.22	2,279,735.89	2,279,735.89
51355355	REPARACIÓN Y MANTENIMIENTO DE EQUIPO DE TRANSPORTE	0.00		2,345,803.11	66,067.22	2,279,735.89	2,279,735.89
51355355001	GASTO CORRIENTE	0.00		664,577.00	66,067.22	598,509.78	598,509.78
51355355001001	MANTENIMIENTO Y CONSERVACION DE VEHICULOS TERRESTRES	0.00		664,577.00	66,067.22	598,509.78	598,509.78
51355355003	SEGURIDAD PÚBLICA	0.00		1,681,226.11	0.00	1,681,226.11	1,681,226.11
51355355003001	MANTENIMIENTO Y CONSERVACION DE VEHICULOS TERRESTRES	0.00		1,681,226.11	0.00	1,681,226.11	1,681,226.11
51357	INSTALACION, REPARACION Y MANTENIMIENTO DE MAQUINARIA, OTROS EQUIPOS Y HERRAMIENTA	0.00		23,872.80	0.00	23,872.80	23,872.80
51357357	INSTALACION, REPARACION Y MANTENIMIENTO DE MAQUINARIA, OTROS EQUIPOS Y HERRAMIENTAS	0.00		23,872.80	0.00	23,872.80	23,872.80
51357357001	GASTO CORRIENTE	0.00		23,872.80	0.00	23,872.80	23,872.80
51357357001001	MANTENIMIENTO Y CONSERVACION DE MAQUINARIA Y EQUIPO	0.00		23,872.80	0.00	23,872.80	23,872.80
51358	SERVICIOS DE LIMPIEZA Y MANEJO DE DESECHOS	0.00		297,616.00	0.00	297,616.00	297,616.00
51358358	SERVICIOS DE LIMPIEZA Y MANEJO DE DESECHOS.	0.00		297,616.00	0.00	297,616.00	297,616.00
51358358001	GASTO CORRIENTE	0.00		297,616.00	0.00	297,616.00	297,616.00
51358358001002	MANEJO DE RESIDUOS SOLIDOS	0.00		297,616.00	0.00	297,616.00	297,616.00
51359	SERVICIOS DE JARDINERIA Y FUMIGACION	0.00		509,420.58	0.00	509,420.58	509,420.58
51359359	SERVICIOS DE JARDINERIA Y FUMIGACION.	0.00		509,420.58	0.00	509,420.58	509,420.58
51359359001	GASTO CORRIENTE	0.00		509,420.58	0.00	509,420.58	509,420.58
51359359001002	SERVICIOS DE JARDINERIA Y FUMIGACION	0.00		509,420.58	0.00	509,420.58	509,420.58
5136	MANTENIMIENTO DE FUENTES Y JARDINES	0.00		2,900.00	0.00	2,900.00	2,900.00
51361	SERVICIOS DE COMUNICACION SOCIAL Y PUBLICIDAD	0.00		506,520.58	0.00	506,520.58	506,520.58
51361361	DIFUSION POR RADIO, TELEVISION Y OTROS MEDIOS DE MENSAJES SOBRE PROGRAMAS Y ACTIVIDADES GUBERNAMENTALES	0.00		4,624,156.70	0.00	4,624,156.70	4,624,156.70
51361361001	DIFUSION POR RADIO, TELEVISION Y OTROS MEDIOS DE MENSAJES SOBRE PROGRAMAS Y ACTIVIDADES GUBERNAMENTALES	0.00		4,292,644.20	0.00	4,292,644.20	4,292,644.20
51361361001001	ACTIVIDADES GUBERNAMENTALES	0.00		4,292,644.20	0.00	4,292,644.20	4,292,644.20

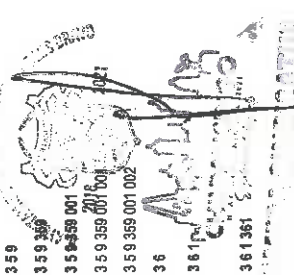



H. AYUNTAMIENTO MUNICIPAL DE CHILPANCINGO, GRO.  
SECRETARIA DE FINANZAS Y ADMINISTRACION

CONSOLIDADO



BALANZA DE COMPROBACIÓN DEL 1 DE ENERO AL 31 DE DICIEMBRE DEL 2019

C U E N T A	C O N C E P T O	SALDOS INICIALES		MOVIMIENTOS		SALDOS ACUMULADOS	
		AL 1 DE ENERO DE 2019		ENERO - DICIEMBRE 2019		AL 31 DE DICIEMBRE DE 2019	
		DEBE	HABER	DEBE	HABER	DEBE	HABER
51361361001	GASTO CORRIENTE	0.00		4,042,644.20		0.00	
51361361001001	DIFUSION DE MENSAJES SOBRE PROGRAMAS Y ACTIVIDADES GUBERNAMENTALES	0.00		4,042,644.20		0.00	
51361361007	FORTASEG	0.00		250,000.00		0.00	
51361361007026	EJERCICIO 2019	0.00		250,000.00		0.00	
51361361007026001	DIFUSION EXTERNA (CONVOCATORIA PARA POLICIA MUNICIPAL)	0.00		250,000.00		0.00	
51363	SERVICIOS DE CREATIVIDAD, PREPRODUCCION Y PRODUCCION DE PUBLICIDAD, EXCEPTO INTERNET	0.00		270,888.00		0.00	
51363363	SERVICIOS DE CREATIVIDAD, PREPRODUCCION Y PRODUCCION DE PUBLICIDAD, EXCEPTO INTERNET	0.00		270,888.00		0.00	
51363363001	GASTO CORRIENTE	0.00		270,888.00		0.00	
51363363001001	SERVICIOS DE CREATIVIDAD, REPRODUCCION Y PRODUCCION DE PUBLICIDAD EXCEPTO INTERNET	0.00		270,888.00		0.00	
51364	SERVICIOS DE REVELADO DE FOTOGRAFÍAS	0.00		56,912.50		0.00	
51364364	SERVICIOS DE REVELADO DE FOTOGRAFÍAS.	0.00		56,912.50		0.00	
51364364001	GASTO CORRIENTE	0.00		56,912.50		0.00	
51364364001001	SERVICIO DE REVELADO DE FOTOGRAFÍAS	0.00		56,912.50		0.00	
51365	SERVICIOS DE LA INDUSTRIA FILMICA, DEL SONIDO Y DEL VIDEO	0.00		3,712.00		0.00	
51365365	SERVICIOS DE LA INDUSTRIA FILMICA, DEL SONIDO Y DEL VIDEO.	0.00		3,712.00		0.00	
51365365001	GASTO CORRIENTE	0.00		3,712.00		0.00	
51365365001001	SERVICIOS DE LA INDUSTRIA FILMICA, DEL SONIDO Y DEL VIDEO	0.00		3,712.00		0.00	
5137	SERVICIOS DE TRASLADO Y VIÁTICOS	0.00		423,401.44		0.00	
51372	PASAJES TERRESTRES	0.00		84,950.40		0.00	
51372372	PASAJES TERRESTRES	0.00		84,950.40		0.00	
51372372001	GASTO CORRIENTE	0.00		50,592.72		0.00	
51372372001001	CAMPO Y SUPERVISION	0.00		34,535.90		0.00	
51372372001004	PASAJES TERRESTRES NACIONALES PARA SERVIDORES PUBLICOS DE MANDO EN EL DESEMPEÑO DE COMISIONES Y FUNCIONES OFICIALES	0.00		16,056.82		0.00	
51372372003	SEGURIDAD PUBLICA	0.00		34,357.68		0.00	
51372372003002	PASAJES TERRESTRES ASOCIADOS CON PROGRAMAS DE SEGURIDAD PUBLICA Y NACIONAL	0.00		34,357.68		0.00	
51375	VIÁTICOS EN EL PAÍS	0.00		338,451.04		0.00	
51375375	VIÁTICOS EN EL PAÍS	0.00		338,451.04		0.00	

*[Handwritten signature and stamp]*

*[Handwritten signature and stamp]*





H. AYUNTAMIENTO MUNICIPAL DE CHILPANCINGO, GRO.

SECRETARIA DE FINANZAS Y ADMINISTRACION

CONSOLIDADO



BALANZA DE COMPROBACIÓN DEL 1 DE ENERO AL 31 DE DICIEMBRE DEL 2019

C U E N T A	C O N C E P T O	SALDOS INICIALES		MOVIMIENTOS		SALDOS ACUMULADOS	
		AL 1 DE ENERO DE 2019		ENERO - DICIEMBRE 2019		AL 31 DE DICIEMBRE DE 2019	
		DEBE	HABER	DEBE	HABER	DEBE	HABER
51375375001	GASTO CORRIENTE	0.00		325,073.04		325,073.04	
51375375001001	VIATICOS NACIONALES PARA SERVIDORES PUBLICOS EN EL DESEMPEÑO DE FUNCIONES OFICIALES	0.00		288,573.04		288,573.04	
51375375001004	VIATICOS NACIONALES PARA SERVIDORES PUBLICOS EN EL DESEMPEÑO DE FUNCIONES OFICIALES	0.00		8,500.00		8,500.00	
51375375001005	VIATICOS NACIONALES PARA LA COORDINACION DEL PROG. FORTASEG	0.00		48,000.00		48,000.00	
51375375003	SEGURIDAD PUBLICA	0.00		13,378.00		13,378.00	
51375375003004	VIATICOS NACIONALES PARA SERVIDORES PUBLICOS EN EL DESEMPEÑO DE FUNCIONES OFICIALES	0.00		13,378.00		13,378.00	
5138	SERVICIOS OFICIALES	0.00		4,405,532.83		4,405,532.83	
51382	GASTOS DE ORDEN SOCIAL Y CULTURAL	0.00		3,135,566.30		3,135,566.30	
51382382	GASTOS DE ORDEN SOCIAL Y CULTURAL	0.00		3,135,566.30		3,135,566.30	
51382382001	GASTO CORRIENTE	0.00		3,102,366.30		3,102,366.30	
51382382001001	GASTOS DE ORDEN SOCIAL	0.00		33,200.00		33,200.00	
51382382003	SEGURIDAD PUBLICA	0.00		33,200.00		33,200.00	
51382382003001	GASTOS DE ORDEN SOCIAL	0.00		33,200.00		33,200.00	
51385	GASTOS DE REPRESENTACIÓN	0.00		1,269,966.53		1,269,966.53	
51385385	GASTOS DE REPRESENTACION	0.00		1,269,966.53		1,269,966.53	
51385385001	GASTO CORRIENTE	0.00		1,269,966.53		1,269,966.53	
51385385001002	GASTOS DE REPRESENTACION (GASTOS DE ALIMENTACION)	0.00		1,248,088.14		1,248,088.14	
51385385001003	GASTOS DE HOSPEDAJE DE SERVIDORES PUBLICOS DE MANDO	0.00		21,878.39		21,878.39	
5139	OTROS SERVICIOS GENERALES	0.00		8,577,889.20		8,577,889.20	
51392	IMPUESTOS Y DERECHOS	0.00		1,837,306.06		1,837,306.06	
51392392	IMPUESTOS Y DERECHOS	0.00		1,837,306.06		1,837,306.06	
51392392001	GASTO CORRIENTE	0.00		42,498.00		42,498.00	
51392392001002	OTROS IMPUESTOS Y DERECHOS	0.00		42,498.00		42,498.00	
51392392003	SEGURIDAD PUBLICA	0.00		1,794,808.06		1,794,808.06	
51392392003002	OTROS IMPUESTOS Y DERECHOS (PAGO DE ISR DIFERENCIA EN TIMBRADO)	0.00		1,794,808.06		1,794,808.06	
51394	SENTENCIAS Y RESOLUCIONES POR AUTORIDAD COMPETENTE	0.00		1,655,598.29		1,655,598.29	
51394394	SENTENCIAS Y RESOLUCIONES POR AUTORIDAD COMPETENTE	0.00		1,655,598.29		1,655,598.29	
51394394001	GASTO CORRIENTE	0.00		1,655,598.29		1,655,598.29	
51394394001001	DEVOLUCIONES DE IMPUESTOS	0.00		41,428.73		41,428.73	

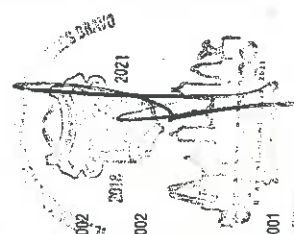
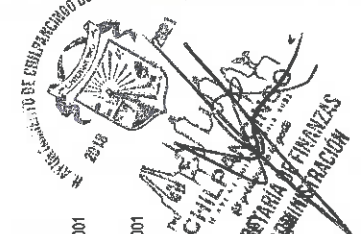

H. Ayuntamiento Municipal Chilpancingo, Gro.  
CONTRALORIA INTERNA MUNICIPAL





H. AYUNTAMIENTO MUNICIPAL DE CHILPANCINGO, GRO.

SECRETARIA DE FINANZAS Y ADMINISTRACION

CONSOLIDADO



BALANZA DE COMPROBACIÓN DEL 1 DE ENERO AL 31 DE DICIEMBRE DEL 2019

C U E N T A	C O N C E P T O	SALDOS INICIALES		MOVIMIENTOS		SALDOS ACUMULADOS	
		AL 1 DE ENERO DE 2019		ENERO - DICIEMBRE 2019		AL 31 DE DICIEMBRE DE 2019	
		DEBE	HABER	DEBE	HABER	DEBE	HABER
51394394001002	SENTENCIAS Y RESOLUCIONES JUDICIALES	0.00	0.00	1,614,169.56	0.00	1,614,169.56	0.00
51395	PENAS, MULTAS, ACCESORIOS Y ACTUALIZACIONES	0.00	0.00	921,350.85	0.00	921,350.85	0.00
51395395	PENAS, MULTAS, ACCESORIOS Y ACTUALIZACIONES.	0.00	0.00	921,350.85	0.00	921,350.85	0.00
51395395001	GASTO CORRIENTE	0.00	0.00	907,974.85	0.00	907,974.85	0.00
51395395001001	PENAS, MULTAS ACCESORIOS Y ACTUALIZACIONES	0.00	0.00	907,974.85	0.00	907,974.85	0.00
51395395003	SEGURIDAD PUBLICA	0.00	0.00	13,376.00	0.00	13,376.00	0.00
51395395003001	PENAS, MULTAS ACCESORIOS Y ACTUALIZACIONES	0.00	0.00	13,376.00	0.00	13,376.00	0.00
51398	IMPUESTO SOBRE NÓMINAS Y OTROS QUE SE DERIVEN DE UNA RELACION LABORAL	0.00	0.00	4,163,634.00	0.00	4,163,634.00	0.00
51398398	IMPUESTOS SOBRE NÓMINAS Y OTROS QUE SE DERIVEN DE UNA RELACION LABORAL	0.00	0.00	4,163,634.00	0.00	4,163,634.00	0.00
51398398001	GASTO CORRIENTE	0.00	0.00	3,351,088.94	0.00	3,351,088.94	0.00
51398398001001	IMPUESTO SOBRE NÓMINAS	0.00	0.00	3,351,088.94	0.00	3,351,088.94	0.00
51398398003	IMPUESTO SOBRE NÓMINAS	0.00	0.00	812,545.06	0.00	812,545.06	0.00
51398398003001	IMPUESTO SOBRE NÓMINAS	0.00	0.00	812,545.06	0.00	812,545.06	0.00
52	TRANSFERENCIAS, ASIGNACIONES, SUBSIDIOS Y OTRAS AYUDAS	0.00	0.00	43,871,179.42	1,015,000.00	42,856,179.42	1,015,000.00
523	SUBSIDIOS	0.00	0.00	32,397,107.69	1,000,000.00	31,397,107.69	1,000,000.00
5231	SUBSIDIOS A LA PRESTACIÓN DE SERVICIOS PUBLICOS	0.00	0.00	32,397,107.69	1,000,000.00	31,397,107.69	1,000,000.00
52314	SUBSIDIOS A LA PRESTACION DE SERVICIOS PUBLICOS.	0.00	0.00	32,397,107.69	1,000,000.00	31,397,107.69	1,000,000.00
52314434	GASTO CORRIENTE	0.00	0.00	32,397,107.69	1,000,000.00	31,397,107.69	1,000,000.00
52314434001002	SUBSIDIOS A LA C.A.P.A.C.H. (GOBIERNO MUNICIPAL)	0.00	0.00	32,397,107.69	1,000,000.00	31,397,107.69	1,000,000.00
52314434001005	SUBSIDIOS A LA C.A.P.A.C.H. (GOBIERNO DEL ESTADO)	0.00	0.00	7,171,912.84	0.00	7,171,912.84	0.00
52314434001002	SUBSIDIOS A LA C.A.P.A.C.H. (DEVOLUCION DE ISR)	0.00	0.00	8,749,239.08	1,000,000.00	7,749,239.08	1,000,000.00
52314434001003	SUBSIDIO AL PATRONATO DE LA FERIA	0.00	0.00	11,632,791.30	0.00	11,632,791.30	0.00
52314434001006	APOYO AL CLUB DE FUTBOL AVISPONES DE CHILPANCINGO	0.00	0.00	4,000,000.00	0.00	4,000,000.00	0.00
52314434001010	APOYO AL DIF MUNICIPAL	0.00	0.00	705,485.47	0.00	705,485.47	0.00
524	SUBSIDIOS INV/CH	0.00	0.00	25,375.00	0.00	25,375.00	0.00
5241	AYUDAS SOCIALES A PERSONAS	0.00	0.00	112,304.00	0.00	112,304.00	0.00
52411	AYUDAS SOCIALES A PERSONAS	0.00	0.00	7,158,677.47	15,000.00	7,143,677.47	15,000.00
52411441	AYUDAS SOCIALES A PERSONAS	0.00	0.00	5,758,563.67	15,000.00	5,743,563.67	15,000.00
52411441	AYUDAS SOCIALES A PERSONAS	0.00	0.00	5,758,563.67	15,000.00	5,743,563.67	15,000.00

Handwritten signature and stamp

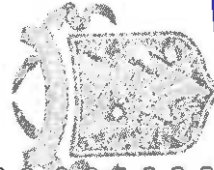



H. AYUNTAMIENTO MUNICIPAL DE CHILPANCINGO, GRO.  
SECRETARIA DE FINANZAS Y ADMINISTRACION  
CONSOLIDADO



BALANZA DE COMPROBACIÓN DEL 1 DE ENERO AL 31 DE DICIEMBRE DEL 2019

C U E N T A	C O N C E P T O	SALDOS INICIALES		MOVIMIENTOS		SALDOS ACUMULADOS	
		AL 1 DE ENERO DE 2019		ENERO - DICIEMBRE 2019		AL 31 DE DICIEMBRE DE 2019	
		DEBE	HABER	DEBE	HABER	DEBE	HABER
52411441001	GASTO CORRIENTE	0.00		5,788,563.67	15,000.00	5,743,563.67	
52411441001001	GASTOS RELACIONADOS CON ACTIVIDADES CULTURALES, DEPORTIVAS Y DE AYUDA EXTRAORDINARIA	0.00		871,934.30	0.00	871,934.30	
52411441001002	GASTOS POR SERVICIOS DE TRASLADO DE PERSONAS	0.00		124,327.79	0.00	124,327.79	
52411441001004	PREMIOS ESTIMULOS, RECOMPENSAS, BECAS Y ESTIMULOS A DEPORTISTAS	0.00		700.00	0.00	700.00	
52411441001007	FUNERARIOS	0.00		375,406.48	0.00	375,406.48	
52411441001008	COMISARIOS	0.00		102,876.75	0.00	102,876.75	
52411441001011	FOMENTO DEPORTIVO	0.00		239,037.22	0.00	239,037.22	
52411441001012	AYUDAS SOCIALES PARA FOMENTO CULTURAL	0.00		124,000.00	0.00	124,000.00	
52411441001013	AYUDAS PARA MEDICAMENTOS Y SERVICIOS MEDICOS	0.00		191,367.42	0.00	191,367.42	
52411441001014	AYUDAS PARA TRANSPORTE	0.00		129,876.00	0.00	129,876.00	
52411441001015	AYUDAS DIVERSAS EN ESPECIE	0.00		922,674.15	0.00	922,674.15	
52411441001016	OTRAS AYUDAS SOCIALES A PERSONAS	0.00		1,731,248.66	15,000.00	1,716,248.66	
52411441001017	AYUDAS SOCIALES A COMISARIOS PARA FIESTAS TRADICIONALES Y RELIGIOSAS.	0.00		945,114.90	0.00	945,114.90	
5242	OTRAS AYUDAS SOCIALES A PERSONAS	0.00		1,342,125.00	0.00	1,342,125.00	
52422	OTRAS AYUDAS SOCIALES A PERSONAS	0.00		1,342,125.00	0.00	1,342,125.00	
52422442	OTRAS AYUDAS SOCIALES A PERSONAS	0.00		1,342,125.00	0.00	1,342,125.00	
52422442001	OTRAS AYUDAS SOCIALES A PERSONAS	0.00		1,342,125.00	0.00	1,342,125.00	
52422442001002	OTRAS AYUDAS SOCIALES A PERSONAS	0.00		1,207,125.00	0.00	1,207,125.00	
52422442001006	OTRAS AYUDAS SOCIALES A PERSONAS	0.00		428,000.00	0.00	428,000.00	
52422442007	OTRAS AYUDAS SOCIALES A PERSONAS	0.00		79,025.00	0.00	79,025.00	
52422442007026	OTRAS AYUDAS SOCIALES A PERSONAS	0.00		135,000.00	0.00	135,000.00	
52422442007026001	OTRAS AYUDAS SOCIALES A PERSONAS	0.00		135,000.00	0.00	135,000.00	
5243	OTRAS AYUDAS SOCIALES A PERSONAS	0.00		135,000.00	0.00	135,000.00	
52433	OTRAS AYUDAS SOCIALES A PERSONAS	0.00		57,988.80	0.00	57,988.80	
52433443	OTRAS AYUDAS SOCIALES A PERSONAS	0.00		57,988.80	0.00	57,988.80	
52433443001	OTRAS AYUDAS SOCIALES A PERSONAS	0.00		57,988.80	0.00	57,988.80	
52433443001001	OTRAS AYUDAS SOCIALES A PERSONAS	0.00		57,988.80	0.00	57,988.80	
525	OTRAS AYUDAS SOCIALES A PERSONAS	0.00		4,290,394.26	0.00	4,290,394.26	
5252	OTRAS AYUDAS SOCIALES A PERSONAS	0.00		4,290,394.26	0.00	4,290,394.26	
52522	OTRAS AYUDAS SOCIALES A PERSONAS	0.00		4,290,394.26	0.00	4,290,394.26	

2018



SECRETARIA DE FINANZAS Y ADMINISTRACION  
M. AYUNTAMIENTO MUNICIPAL DE CHILPANCINGO, GRO.  
CONTRALORIA INTERNA MUNICIPAL

miercoles 25 marzo 2020

6:06:00 PM

Coram/ Balanza



H. AYUNTAMIENTO MUNICIPAL DE CHILPANCINGO, GRO.  
SECRETARIA DE FINANZAS Y ADMINISTRACION  
CONSOLIDADO



BALANZA DE COMPROBACION DEL 1 DE ENERO AL 31 DE DICIEMBRE DEL 2019

C U E N T A	C O N C E P T O	SALDOS INICIALES		MOVIMIENTOS		SALDOS ACUMULADOS	
		AL 1 DE ENERO DE 2019		ENERO - DICIEMBRE 2019		AL 31 DE DICIEMBRE DE 2019	
		DEBE	HABER	DEBE	HABER	DEBE	HABER
52522452	JUBILACIONES	0.00				0.00	
52522452001	GASTO CORRIENTE	0.00		4,290,394.26		0.00	4,290,394.26
52522452001001	PAGO DE PENSIONES Y JUBILACIONES CONTRAACTUALES	0.00		4,290,394.26		0.00	4,290,394.26
528	DONATIVOS	0.00				0.00	
5281	DONATIVOS A INSTITUCIONES SIN FINES DE LUCRO	0.00		25,000.00		0.00	25,000.00
52811	DONATIVOS A INSTITUCIONES SIN FINES DE LUCRO	0.00		25,000.00		0.00	25,000.00
52811481	DONATIVOS A INSTITUCIONES SIN FINES DE LUCRO	0.00		25,000.00		0.00	25,000.00
52811481001	GASTO CORRIENTE	0.00		25,000.00		0.00	25,000.00
52811481001001	CRUZ ROJA MEXICANA I A P	0.00		25,000.00		0.00	25,000.00
56	INVERSION PUBLICA	0.00				0.00	
561	INVERSION PUBLICA NO CAPITALIZABLE	0.00		231,062,207.55		16,163,773.97	214,898,433.58
5611	CONSTRUCCION EN BIENES NO CAPITALIZABLE	0.00		231,062,207.55		16,163,773.97	214,898,433.58
56111	EDIFICACION HABITACIONAL	0.00		228,870,151.00		16,163,773.97	212,706,377.03
56111022	FONDO DE APORTACION PARA LA INFRAESTRUCTURA SOCIAL MUNICIPAL	0.00				0.00	
56111022001	MEJORAMIENTO A LA VIVIENDA	0.00		2,142,873.63		0.00	2,142,873.63
56111022001026	EJERCICIO 2019	0.00		2,142,873.63		0.00	2,142,873.63
56111022001026002	CONTRATO	0.00		2,142,873.63		0.00	2,142,873.63
56111022001026002088	AMPLIACION DE LA RED DE ELECTRICA EN LAS CALLES AMAPOLAS Y PETUNIAS, DE LA COLONIA FLORIDA, DE LA LOC. DE CHILPANCINGO, MUNICIPIO DE CHILPANCINGO DE LOS BRAVO GRO.	0.00		485,592.56		0.00	485,592.56
56111022001026002088001	AMPLIACION DE LA RED DE ELECTRICA EN EL CIRCUITO CUJTLAHUAC, DE LA COLONIA RENOVACION, DE LA LOC. DE CHILPANCINGO, MUNICIPIO DE CHILPANCINGO DE LOS BRAVO GRO.	0.00		244,702.81		0.00	244,702.81
56111022001026002088002	AMPLIACION DE LA RED DE ELECTRICA EN LA CALLE LINALOE, DE LA COLONIA ALBORADA, DE LA LOC. DE CHILPANCINGO, MUNICIPIO DE CHILPANCINGO DE LOS BRAVO, GRO.	0.00				0.00	
56111022001026002088003	AMPLIACION DE LA RED DE ELECTRICA EN LA CALLE LINDA VISTA, DE LA COLONIA MIRABAL, DE LA LOC. DE CHILPANCINGO, MUNICIPIO DE CHILPANCINGO DE LOS BRAVO, GRO.	0.00				0.00	
56111022001026002088004	AMPLIACION DE LA RED DE ELECTRICA EN LA CALLE MELCHOR OCAMPO EN EL BARRIO DE SANTA CRUZ, DE LA LOC. DE PETAQUILLAS, MUNICIPIO DE CHILPANCINGO DE LOS BRAVO GRO.	0.00		285,583.68		0.00	285,583.68
56111022001026002088005	AMPLIACION DE LA RED DE ELECTRICA EN LA	0.00		531,586.64		0.00	531,586.64
56111022001026002088006	AMPLIACION DE LA RED DE ELECTRICA EN LA	0.00		281,007.34		0.00	281,007.34

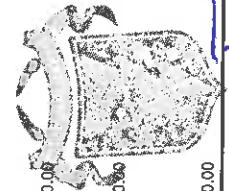
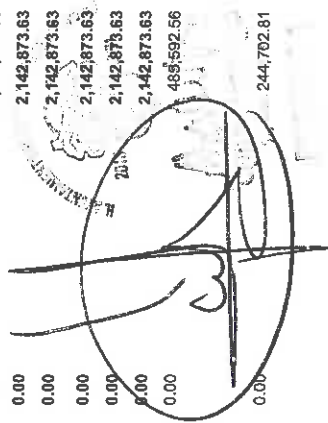

M. Ayuntamiento Municipal Municipal de Chilpancingo, Gro. CONTRA CONTABILIDAD



H. AYUNTAMIENTO MUNICIPAL DE CHILPANCINGO, GRO.  
SECRETARIA DE FINANZAS Y ADMINISTRACION

CONSOLIDADO



BALANZA DE COMPROBACIÓN DEL 1 DE ENERO AL 31 DE DICIEMBRE DEL 2019

C U E N T A	C O N C E P T O	SALDOS INICIALES		MOVIMIENTOS		SALDOS ACUMULADOS	
		AL 1 DE ENERO DE 2019		ENERO - DICIEMBRE 2019		AL 31 DE DICIEMBRE DE 2019	
		DEBE	HABER	DEBE	HABER	DEBE	HABER
56112	COLONIA TLACUMULCO, DE LA LOC. DE CHILPANCINGO, MUNICIPIO DE CHILPANCINGO DE LOS BRAVO, GRO.	0.00				25,729,316.16	
56112022	EDIFICACION NO HABITACIONAL	0.00		25,729,316.16		25,729,316.16	
56112022001	FONDO DE APORTACION PARA LA INFRAESTRUCTURA SOCIAL MUNICIPAL	0.00		3,457,162.48		3,457,162.48	
56112022001026	INFRAESTRUCTURA BASICA DE SALUD EJERCICIO 2019	0.00		3,457,162.48		3,457,162.48	
56112022001026002	CONTRATO	0.00		3,457,162.48		3,457,162.48	
56112022001026002001	CONSTRUCCION DE DISPENSARIO MEDICO EN LA LOC. DE RINCON DE LA VIA, MUNICIPIO DE CHILPANCINGO DE LOS BRAVO ESTADO DE GUERRERO	0.00		965,046.28		965,046.28	
56112022001026002002	CONSTRUCCION DE DISPENSARIO MEDICO EN LA LOC. RINCON DE ALCAPARROSA, MUNICIPIO DE CHILPANCINGO DE LOS BRAVO, ESTADO DE GUERRERO	0.00		923,548.76		923,548.76	
56112022001026002003	CONSTRUCCION DE CENTRO DE SALUD SEGUNDA ETAPA EN LA LOCALIDAD DE JULIAN BLANCO MUNICIPIO DE CHILPANCINGO DE LOS BRAVO, GUERRERO	0.00		1,568,567.44		1,568,567.44	
56112022002	INFRAESTRUCTURA BASICA DE EDUCACION EJERCICIO 2019	0.00				22,272,153.68	
56112022002026	CONTRATO	0.00		22,272,153.68		22,272,153.68	
56112022002026002	CONSTRUCCION DE AULA PARA IMPARTICION DE EDUCACION FISICA EN LA ESCUELA ELEMENTARIA NICOLAS BRAVO DE LA LOC. DE LA CAHUIZOTLA, MPIO. DE CHILPANCINGO DE LOS BRAVO, GUERRERO.	0.00		22,272,153.68		22,272,153.68	
56112022002026002001	CONSTRUCCION DE COMEDOR ESCOLAR EN EL JARDIN DE NIÑOS CARITINO MALDONADO, DE LA LOCALIDAD DE CHILPANCINGO DE LOS BRAVO, ESTADO DE GUERRERO.	0.00		1,517,226.35		1,517,226.35	
56112022002026002003	CONSTRUCCION DE COMEDOR ESCOLAR EN ESC PRIM EN LA LOC DE CARRIZAL DEL PINZON, EN EL MUNICIPIO DE CHILPANCINGO GRO	0.00		906,960.95		906,960.95	
56112022002026002004	CONSTRUCCION DE COMEDOR ESCOLAR EN LA ESC. PRIM. DE LA LOC DE RENACIMIENTO AGUA HERNANDEZ NPIO. DE CHILPANCINGO DE LOS BRAVO, ESTADO DE GUERRERO	0.00		1,680,500.00		1,680,500.00	
56112022002026002005	CONSTRUCCION DE COMEDOR ESCOLAR EN LA LOCALIDAD DE TEPECHICOTLAN, MUNICIPIO DE CHILPANCINGO DE LOS BRAVO, ESTADO DE GUERRERO	0.00		1,077,455.13		1,077,455.13	
56112022002026002006	CONSTRUCCION DE COMEDOR ESCOLAR EN EL JARDIN DE NIÑOS FRIDA KAHLO DE LA LOC. DE CAJELITOS, MUNICIPIO DE CHILPANCINGO DE LOS BRAVO, ESTADO DE GUERRERO	0.00		1,437,097.54		1,437,097.54	
56112022002026002007	CONSTRUCCION DE BANDA PERIMETRAL EN LA	0.00		530,186.33		530,186.33	
Coram/ Balanza		0.00		718,355.27		718,355.27	

6.08.08 PM  
miércoles 25 marzo 2020

H. Ayuntamiento Municipal de Chilpancingo, Gro.  
SECRETARIA DE FINANZAS Y ADMINISTRACION





H. AYUNTAMIENTO MUNICIPAL DE CHILPANCINGO, GRO.  
SECRETARIA DE FINANZAS Y ADMINISTRACION  
CONSOLIDADO



BALANZA DE COMPROBACION DEL 1 DE ENERO AL 31 DE DICIEMBRE DEL 2019

C U E N T A	C O N C E P T O	SALDOS INICIALES		MOVIMIENTOS		SALDOS ACUMULADOS	
		AL 1 DE ENERO DE 2019		ENERO - DICIEMBRE 2019		AL 31 DE DICIEMBRE DE 2019	
		DEBE	HABER	DEBE	HABER	DEBE	HABER
56112022002026002008	ESC. PRIM. VICENTE GUERRERO DE LA LOCALIDAD DE RIO VERDE, MUNICIPIO DE CHILPANCINGO DE LOS BRAVO, ESTADO DE GUERRERO	0.00		1,258,289.86	0.00	1,258,289.86	
56112022002026002009	CONSTRUCCION DE COMEDOR EN EL TELEBACHILLERATO DE LA LOC. DE CHACOCUYULLO, MPIO DE CHILPANCINGO DE LOS BRAVO, ESTADO DE GUERRERO	0.00		486,390.13	0.00	486,390.13	
56112022002026002010	REHABILITACION DE MURO DE CONTENCIÓN Y BARRA PERIMETRAL EN LA ESCUELA PRIMARIA SIMON BOLIVAR CON C.T. 12DPR0504T EN LA COLONIA LA CIMA DE LA LOC. DE CHILPANCINGO, MPIO DE CHILPANCINGO DE LOS BRAVO, GRO.	0.00		1,277,264.24	0.00	1,277,264.24	
56112022002026002011	CONSTRUCCION DE COMEDOR ESCOLAR EN LA ESC. PRIM. EMPERADOR CUAUHTEMOC, DE LA COL. GUERRERO 200, EN LA LOCALIDAD DE CHILPANCINGO DE LOS BRAVO, ESTADO DE GUERRERO	0.00		1,118,402.05	0.00	1,118,402.05	
56112022002026002012	CONSTRUCCION DE COMEDOR ESCOLAR EN EL TELEBACHILLERATO COMUNITARIO 036 DE LA COMUNIDAD DE ACAHUIZOTLA, MUNICIPIO DE CHILPANCINGO DE LOS BRAVO, ESTADO DE GUERRERO	0.00		1,428,706.46	0.00	1,428,706.46	
56112022002026002013	CONSTRUCCION DE COMEDOR ESCOLAR EN LA ESC. PRIM. VICENTE GUERRERO DE LA LOC. DE MOHONERAS, MPIO. DE CHILPANCINGO DE LOS BRAVO, ESTADO DE GUERRERO	0.00		833,809.74	0.00	833,809.74	
56112022002026002014	CONSTRUCCION DE BARRA PERIMETRAL EN EL CENTRO DE BACHILLERATO TECNOLOGICO AGROPECUARIO N° 225 DE LA LOC. DE BUENA VISTA, MPIO. DE CHILPANCINGO DE LOS BRAVO, ESTADO DE GUERRERO	0.00		621,035.49	0.00	621,035.49	
56112022002026002015	CONSTRUCCION DE COMEDOR ESCOLAR EN LA ESC. PRIM. JOSE MARTI, COL. CAMINOS, EN CHILPANCINGO DE LOS BRAVO, GRO	0.00		514,299.98	0.00	514,299.98	
56112022002026002016	CONSTRUCCION DE TECHADO EN AREA DE IMPARTICION DE EDUCACION FISICA EN LA ESC. PRIM. LEONA VICARIO, EN LA COLONIA ATLITENCO DE ALTAMIRA, LOC. DE CHILPANCINGO, MUNICIPIO DE CHILPANCINGO DE LOS BRAVO.	0.00		1,080,173.54	0.00	1,080,173.54	
56112022002026002017	CONSTRUCCION DE TECHADO EN AREA DE IMPARTICION DE EDUCACION FISICA EN LA ESC. PRIM. 18 DE MARZO CON C.T. 12DPR0418X, EN LA COLONIA AMPLIACION LAZARO CARDENAS, LOC. DE CHILPANCINGO, MUNICIPIO DE CHILPANCINGO DE LOS BRAVO.	0.00		980,746.53	0.00	980,746.53	
56112022002026002018	CONSTRUCCION DE TECHADO EN AREA DE IMPARTICION DE EDUCACION FISICA EN EL	0.00		781,777.64	0.00	781,777.64	

*[Handwritten signature and stamp]*

*[Handwritten signature and stamp]*



El Ayuntamiento Municipal de Chilpancingo, Gro.  
SECRETARIA DE FINANZAS Y ADMINISTRACION





H. AYUNTAMIENTO MUNICIPAL DE CHILPANCINGO, GRO.  
SECRETARIA DE FINANZAS Y ADMINISTRACION  
CONSOLIDADO



BALANZA DE COMPROBACIÓN DEL 1 DE ENERO AL 31 DE DICIEMBRE DEL 2019

C U E N T A	C O N C E P T O	SALDOS INICIALES		MOVIMIENTOS		SALDOS ACUMULADOS	
		AL 1 DE ENERO DE 2019		ENERO - DICIEMBRE 2019		AL 31 DE DICIEMBRE DE 2019	
		DEBE	HABER	DEBE	HABER	DEBE	HABER
5611202200202600202001	JARDIN DE NIÑOS ANNA FREUD C.C.T. 12DJN2845N EN LA CALLE CHIAPAS, EN LA COLONIA LOMAS DE XOCOMULCO, LOC. DE CHILPANCINGO. MUNICIPIO DE CHILPANCINGO DE LOS BRAVO.	0.00		1,105,998.59	0.00	1,105,998.59	
5611202200202600202002	CONSTRUCCION DE COMEDOR ESCOLAR EN LA ESC. PRIM. LUIS CORDOVA REYES CON C.C.T. 12DPR6970W EN LA COLONIA WENCESLAO SOTO, LOC. DE CHILPANCINGO. MUNICIPIO DE CHILPANCINGO DE LOS BRAVO.	0.00		289,659.25	0.00	289,659.25	
5611202200202600202001	JARDIN DE NIÑOS AARON M. FLORES MOCTEZUMA CON C.C.T. 12DJND219H EN LA COLONIA PRIMER CONGRESO DE ANAHUAC, LOC. DE CHILPANCINGO. MUNICIPIO DE CHILPANCINGO DE LOS BRAVO.	0.00		481,406.13	0.00	481,406.13	
5611202200202600202002	CONSTRUCCION DE BANDA PERIMETRAL EN LA ESCUELA PRIMARIA EUCARIA APREZA GARCIA CON C.C.T. 12EPR0005W EN LA COLONIA PPS, LOC. DE CHILPANCINGO. MUNICIPIO DE CHILPANCINGO DE LOS BRAVO.	0.00		525,336.89	0.00	525,336.89	
5611202200202600202024	CONSTRUCCION DE AULA TIPO REGIONAL EN EL JARDIN DE NIÑOS "NIÑOS HEROES" CON C.C.T. 12EJN0599F EN LA COLONIA LIC. NORBERTO FLORES BANGS, LOC. DE CHILPANCINGO. MUNICIPIO DE CHILPANCINGO DE LOS BRAVO.	0.00		531,213.74	0.00	531,213.74	
5611202200202600202025	CONSTRUCCION DE AULA TIPO REGIONAL EN EL TELEBACHILLERATO COMUNITARIO PLANTEL 039 CON C.C.T. 12ETK0039F EN LA LOC. DE INEQUINATOYAC. MUNICIPIO DE CHILPANCINGO DE LOS BRAVO.	0.00		634,861.85	0.00	634,861.85	
5611202200202600202026	CONSTRUCCION DE AULA TIPO REGIONAL EN EL JARDIN DE NIÑOS "JEAN PIAGET" CON C.C.T. 12EJN0017K EN LA LOC. DE CHILPANCINGO. MUNICIPIO DE CHILPANCINGO DE LOS BRAVO.	0.00		455,000.00	0.00	455,000.00	
56113022002	CONSTRUCCION DE OBRAS PARA EL ABASTECIMIENTO DE AGUA, PETROLEO, GAS, ELECTRICIDAD Y TELECOMUNICACION FONDO DE APORTACION PARA LA INFRAESTRUCTURA SOCIAL MUNICIPAL	0.00		89,670,135.13	721,476.83	88,948,658.30	
56113022002	AGUA Y SANEAMIENTO	0.00		85,856,748.96	721,476.83	85,135,272.13	
56113022002026	EJERCICIO 2019	0.00		85,856,748.96	721,476.83	85,135,272.13	
56113022002026001	CONTRATO REHABILITACION DE ALCANTARILLADO SANITARIO, INTRODUCCION DE RED DE DISTRIBUCION DE AGUA POTABLE Y	0.00		85,856,748.96	721,476.83	85,135,272.13	
		0.00		1,305,454.78	0.00	1,305,454.78	

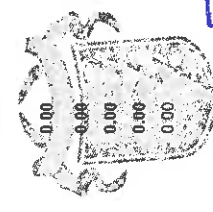
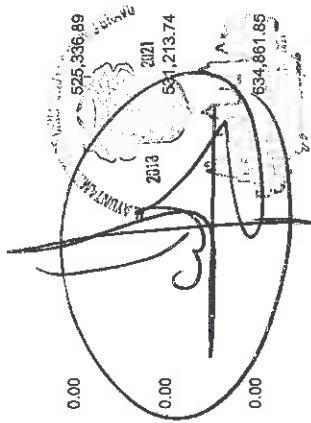



H. AYUNTAMIENTO MUNICIPAL DE CHILPANCINGO, GRO.  
SECRETARIA DE FINANZAS Y ADMINISTRACION  
CONSOLIDADO



BALANZA DE COMPROBACION DEL 1 DE ENERO AL 31 DE DICIEMBRE DEL 2019

C U E N T A	C O N C E P T O	SALDOS INICIALES		MOVIMIENTOS		SALDOS ACUMULADOS	
		AL 1 DE ENERO DE 2019		ENERO - DICIEMBRE 2019		AL 31 DE DICIEMBRE DE 2019	
		DEBE	HABER	DEBE	HABER	DEBE	HABER
56113022002026002002	CANALIZACION DE AGUA PLUVIALES CON CONCRETO HIDRAULICO DE LA CALLE LAURELES DE LA COL. LOMAS DEL PONIENTE DE LA CIUDAD CHILPANCINGO DE LOS BRAVO, ESTADO DE GUERRERO.	0.00		671,795.73	0.00	671,795.73	
56113022002026002003	REHABILITACION DE ALCANTARILLADO SANITARIO, INTRODUCCION DE RED DE DISTRIBUCION DE AGUA POTABLE Y CANALIZACION DE AGUAS PLUVIALES CON CONCRETO HIDRAULICO DE LA CALLE ORQUIDEAS DE LA COL. LOMAS DEL PONIENTE DE LA CIUDAD DE CHILPANCINGO DE LOS BRAVO, ESTADO DE GUERRERO.	0.00		983,139.18	0.00	983,139.18	
56113022002026002004	REHABILITACION DE ALCANTARILLADO SANITARIO Y CANALIZACION DE AGUAS PLUVIALES CON CONCRETO HIDRAULICO EN LA CALLE ANTIGUA CARRETERA A AMOJILECA SEGUNDA ETAPA, EN LA COL. HUACAPITA DE LA CIUDAD DE CHILPANCINGO DE LOS BRAVO, GUERRERO.	0.00		1,285,755.23	0.00	1,285,755.23	
56113022002026002005	DESAZOLVE DEL ALCANTARILLADO PLUVIAL EN LA COLONIA GALEANA TRAMO: DEPORTIVO LOS GALEANA - CALLE INDUSTRIAL COL. SAN RAFAEL NORTE, EN LA CIUDAD DE CHILPANCINGO DE LOS BRAVO, GUERRERO.	0.00		1,000,000.00	0.00	1,000,000.00	
56113022002026002006	DESAZOLVE DEL ALCANTARILLADO PLUVIAL EN LA COLONIA SAN RAFAEL NORTE TRAMO: CALLE INDUSTRIAL - COL. AMPLIACION LAZARO INDUSTRIALES, EN LA CIUDAD DE CHILPANCINGO DE LOS BRAVO, GUERRERO.	0.00		104,253.35	0.00	104,253.35	
56113022002026002007	CANALIZACION DE AGUAS PLUVIALES CON CONCRETO HIDRAULICO EN LA CALLE BELIZARIO DOMINGUEZ DEL BARRIO DE SAN MATEO TRAMO: MARCHONENDOZA - MELCHOR OCCAMPO EN CHILPANCINGO DE LOS BRAVO, GUERRERO.	0.00		701,788.77	0.00	701,788.77	
56113022002026002008	CONSTRUCCION DE DRENAJE SANITARIO EN LA COLONIA LOMAS DE EL HUAJAL, EN CHILPANCINGO DE LOS BRAVO, GUERRERO.	0.00		1,000,000.00	0.00	1,000,000.00	
56113022002026002009	CANALIZACION DE AGUAS PLUVIALES CON CONCRETO HIDRAULICO EN LA CALLE GABRIEL LEYVA ALARCON DE LA COL. SAN RAFAEL ORIENTE DE CHILPANCINGO DE LOS BRAVO, ESTADO DE GUERRERO.	0.00		147,295.66	0.00	147,295.66	
56113022002026002010	CONSTRUCCION DE CAJAS TIPO POZO EN LA RED DE ALCANTARILLADO SANITARIO EN LA AV. JOSE FRANCISCO RUIZ MASSIEU DE LA COL. VILLA MODERNA, DE CHILPANCINGO DE LOS BRAVO, EN EL ESTADO DE GUERRERO.	0.00		1,156,325.00	0.00	1,156,325.00	

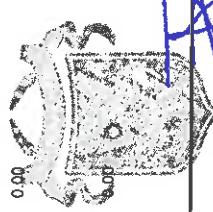





H. AYUNTAMIENTO MUNICIPAL DE CHILPANCINGO, GRO.  
SECRETARIA DE FINANZAS Y ADMINISTRACION  
CONSOLIDADO



BALANZA DE COMPROBACIÓN DEL 1 DE ENERO AL 31 DE DICIEMBRE DEL 2019

C U E N T A	C O N C E P T O	SALDOS INICIALES		MOVIMIENTOS		SALDOS ACUMULADOS	
		AL 1 DE ENERO DE 2019		ENERO - DICIEMBRE 2019		AL 31 DE DICIEMBRE DE 2019	
		DEBE	HABER	DEBE	HABER	DEBE	HABER
56113022002026002022	DE CHILPANCINGO DE LOS BRAVO, ESTADO DE GUERRERO CONSTRUCCION DE ALCANTARILLADO SANITARIO Y PAVIMENTACION CON CONCRETO HIDRAULICO EN LA CALLE DEL PANTEON DE LA LOC. DE AMOJILECA, MPIO. DE CHILPANCINGO DE LOS BRAVO, ESTADO DE GUERRERO CANALIZACION DE AGUAS PLUVIALES CON CONCRETO HIDRAULICO EN LA CALLE AV. CHILPANCINGO DE LA COL. DIANA LAURA, MPIO. DE CHILPANCINGO DE LOS BRAVO, ESTADO DE GUERRERO CANALIZACION DE AGUAS PLUVIALES CON CONCRETO HIDRAULICO EN EL ACCESO PRINCIPAL DE LA COLONIA IGNACIO MANUEL ALTAMIRANO, EN LA LOCALIDAD DE CHILPANCINGO DE LOS BRAVO, ESTADO DE GUERRERO CANALIZACION DE AGUAS PLUVIALES CON CONCRETO HIDRAULICO EN LA CALLE MANZANO DE LA COL. GUADALUPE DE CHILPANCINGO DE LOS BRAVO, ESTADO DE GUERRERO CANALIZACION DE AGUAS PLUVIALES CON CONCRETO HIDRAULICO EN LA CALLE ANDRES MANUEL LOPEZ OBRADOR DE LA COL. PRD. EN LA LOCALIDAD DE CHILPANCINGO DE LOS BRAVO, ESTADO DE GUERRERO CANALIZACION DE AGUAS PLUVIALES CON CONCRETO HIDRAULICO EN LA CALLE SIN NOMBRE DE LA COL. DOCTOR SAUL ALARCON ABARCA, DE CHILPANCINGO DE LOS BRAVO, ESTADO DE GUERRERO CANALIZACION DE AGUAS PLUVIALES CON CONCRETO HIDRAULICO EN LA CALLE PRINCIPAL EN LA COLONIA SANTO DOMINGO, EN LA LOCALIDAD DE CHILPANCINGO, MUNICIPIO DE CHILPANCINGO DE LOS BRAVO, ESTADO DE GUERRERO CONSTRUCCION DE RED DE ALCANTARILLADO SANITARIO EN LA CALLE SIN NOMBRE DE LA LOC. DE PETAQUILLAS, MPIO DE CHILPANCINGO DE LOS BRAVO, ESTADO DE GUERRERO CANALIZACION DE AGUAS PLUVIALES CON CONCRETO HIDRAULICO EN LA CALLE ZHUATANEJC PRIMERA ETAPA UBICADA EN LA COL. SAN RAFAEL NORTE, EN LA LOCALIDAD DE CHILPANCINGO DE LOS BRAVO, ESTADO DE GUERRERO CANALIZACION DE AGUAS PLUVIALES CON CONCRETO HIDRAULICO EN LA CALLE ACCESO PRINCIPAL DE LA COLONIA VALLE DE LAS FLORES PRIMERA ETAPA, EN LA LOCALIDAD DE CHILPANCINGO DE LOS BRAVO, ESTADO DE	0.00	0.00	1,540,111.78	0.10	1,540,111.68	
56113022002026002023		0.00	716,756.49	0.00	716,756.49		
56113022002026002024		0.00	928,562.70	0.00	928,562.70		
56113022002026002025		0.00	985,894.03	0.00	985,894.03		
56113022002026002026		0.00	744,229.56	0.00	744,229.56		
56113022002026002027		0.00	826,862.63	0.00	826,862.63		
56113022002026002028		0.00	796,428.62	0.00	796,428.62		
56113022002026002029		0.00	382,329.64	0.00	382,329.64		
56113022002026002030		0.00	754,317.42	0.00	754,317.42		
56113022002026002031		0.00	795,111.53	0.00	795,111.53		

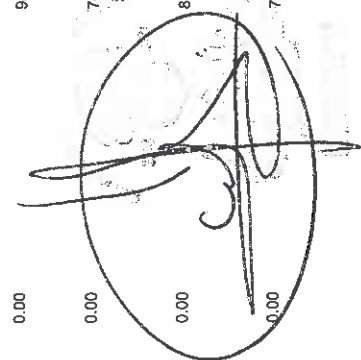
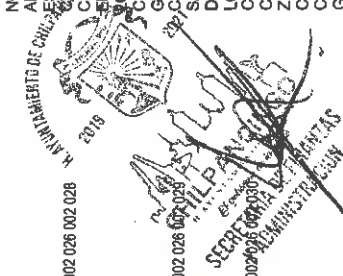

Chilpancingo, Gro.  
CONTRALOR MUNICIPAL





H. AYUNTAMIENTO MUNICIPAL DE CHILPANCINGO, GRO.  
SECRETARIA DE FINANZAS Y ADMINISTRACION  
CONSOLIDADO



BALANZA DE COMPROBACION DEL 1 DE ENERO AL 31 DE DICIEMBRE DEL 2019

C U E N T A	C O N C E P T O	SALDOS INICIALES		MOVIMIENTOS		SALDOS ACUMULADOS	
		AL 1 DE ENERO DE 2019		ENERO - DICIEMBRE 2019		AL 31 DE DICIEMBRE DE 2019	
		DEBE	HABER	DEBE	HABER	DEBE	HABER
56113022002026002032	GUERRERO CANALIZACION DE AGUAS PLUVIALES CON CONCRETO HIDRAULICO EN LA CALLE 24 DE FEBRERO PRIMERA ETAPA EN LA COL. MOVIMIENTO TERRITORIAL URBANO POPULAR EN LA LOCALIDAD DE CHILPANCINGO DE LOS BRAVO, ESTADO DE GUERRERO	0.00		737,710.32	0.00	737,710.32	
56113022002026002034	CANALIZACION DE AGUAS PLUVIALES CON CONCRETO HIDRAULICO, EN LA CALLE RIO BALSAS, COL. AMPLIACION PINO SUAREZ, EN CHILPANCINGO DE LOS BRAVO, GRO.	0.00		398,700.69	0.00	398,700.69	
56113022002026002035	CANALIZACION DE AGUAS PLUVIALES CON CONCRETO HIDRAULICO, EN EL ACCESO RUTA HUAMUCHIL, COL. TELUMBRE, EN CHILPANCINGO DE LOS BRAVO, GRO.	0.00		1,050,561.11	0.00	1,050,561.11	
56113022002026002036	CONSTRUCCION DE RED DE DRENAJE SANITARIO Y FOSA SEPTICA EN LA LOCALIDAD DE TLAHUIZAPA, MPIO. DE CHILPANCINGO DE OS BRAVO, ESTADO DE GUERRERO	0.00		1,049,896.49	0.00	1,049,896.49	
56113022002026002037	REHABILITACION DE LA OBRA DE TOMA Y LINEA DE CONDUCCION DE AGUA POTABLE DE LA LOC. DE HUACALAPA, MPIO. DE CHILPANCINGO DE LOS BRAVO, ESTADO DE GUERRERO	0.00		331,955.05	0.00	331,955.05	
56113022002026002038	CANALIZACION DE AGUAS PLUVIALES CON CONCRETO HIDRAULICO DE ANDADOR Y ACCESO A BARRANCA EN LA COLONIA AMPLIACION JARDINES DEL SUR, EN LA LOCALIDAD DE CHILPANCINGO DE LOS BRAVO, ESTADO DE GUERRERO	0.00		696,702.91	0.00	696,702.91	
56113022002026002039	CANALIZACION DE AGUAS PLUVIALES CON CONCRETO HIDRAULICO EN LA CALLE GRAL. R. LEIVA MANCILLA DE LA COL. VILLAS DE LEIVA, EN LA LOCALIDAD DE CHILPANCINGO DE LOS BRAVO, ESTADO DE GUERRERO	0.00		735,198.75	0.00	735,198.75	
56113022002026002040	CONSTRUCCION DE SISTEMA DE DRENAJE DE LA CALLE 21 DE MARZO, EN LA LOCALIDAD DE CHILPANCINGO, MUNICIPIO DE CHILPANCINGO DE LOS BRAVO.	0.00		7,787,500.00	0.00	7,787,500.00	
56113022002026002041	SUSTITUCION DE 2 EQUIPOS DE BOMBEO DE 75HP, 2 TRENES DE DESCARGA DE 6" CONSTRUCCION DE 1,231.52m DE LINEA DE CONDUCCION DE 8" DE ACERO, CONSTRUCCION DE TANQUE DE 500 M3, CASETA Y EQUIPO DE CLORACION DEL SISTEMA DE AGUA POTABLE EN LA LOCALIDAD DE PETAQUILLAS, MUNICIPIO DE CHILPANCINGO DE LOS BRAVO, PRIMERA ETAPA	0.00		2,149,738.63	0.00	2,149,738.63	
56113022002026002042	REHABILITACION DE 1.6 KM DE TUBERIA DE PVC DE 18", 12" Y 8" DE DIAMETRO Y 218 DESCARGAS DOMICILIARIAS EN LA CALLE TULIPANES (TMO. CALLE TULIPANES-ENCAUZAMIENTO HUACAPA) Y 0.98 KM DE TUBERIA PVC DE 12" DE DIAMETRO Y 85 DESCARGAS DOMICILIARIAS EN AV. RUFFO	0.00		1,968,527.51	0.00	1,968,527.51	





H. AYUNTAMIENTO MUNICIPAL DE CHILPANCINGO, GRO.

SECRETARIA DE FINANZAS Y ADMINISTRACION

CONSOLIDADO



BALANZA DE COMPROBACIÓN DEL 1 DE ENERO AL 31 DE DICIEMBRE DEL 2019

C U E N T A	C O N C E P T O	SALDOS INICIALES		M O V I M I E N T O S		SALDOS ACUMULADOS	
		AL 1 DE ENERO DE 2019		ENERO - DICIEMBRE 2019		AL 31 DE DICIEMBRE DE 2019	
		DEBE	HABER	DEBE	HABER	DEBE	HABER
56113022002026002043	FIGUEROA Y GOBERNADORES (TMO. JACARANDAS-LA CURVA) EN LA LOC. DE CHILPANCINGO, MUNICIPIO DE CHILPANCINGO DE LOS BRAVO.	0.00		8,040,145.70	0.00	8,040,145.70	
56113022002026002044	SUSTITUCION DE 6.38 KM. DE TUBERIA DE PVC DE 8", 6", 4" Y 3" DE DIAMETRO Y 860 TOMAS DOMICILIARIAS DEL SISTEMA DE AGUA POTABLE EN 4 SECTORES HIDROMETRICOS (TOMATAL, LINALOE, VILLAS DE OCOTEPEC Y VALLE ESMERALDA) EN LA LOC. DE CHILPANCINGO, MUNICIPIO DE CHILPANCINGO DE LOS BRAVO.	0.00		2,310,916.74	0.00	2,310,916.74	
56113022002026002045	CONSTRUCCION DE 2.38 KM DE TUBERIA DE PVC DE 4" Y 3" DE DIAMETRO Y 359 TOMAS DOMICILIARIAS EN LA ZONA ORIENTE (COLONIAS MEXICO, REVOLUCION Y NUEVA REVOLUCION) EN LA LOC. DE CHILPANCINGO, MUNICIPIO DE CHILPANCINGO DE LOS BRAVO.	0.00		1,662,601.38	0.00	1,662,601.38	
56113022002026002046	AGUA POTABLE EN LA LOCALIDAD DE ZOYATEPEC; MUNICIPIO DE CHILPANCINGO DE LOS BRAVO GRO.	0.00		828,348.32	0.00	828,348.32	
56113022002026002047	REHABILITACION DE RED DE DRENAJE SANITARIO Y PAVIMENTACION CON CONCRETO HIDRAULICO EN LA CALLE LOS FRESNOS, TRAMO: CALLE LOS SAUCES-CALLE UNION Y PROGRESO DE LA COLONIA EL ENCANTO, EN LA LOC. DE CHILPANCINGO, MUNICIPIO DE CHILPANCINGO DE LOS BRAVO GRO.	0.00		998,739.51	0.00	998,739.51	
56113022002026002048	REHABILITACION DE RED DE DRENAJE SANITARIO EN LA COLONIA ROSARIO IBARRA, EN LA LOC. DE CHILPANCINGO, MUNICIPIO DE CHILPANCINGO DE LOS BRAVO GRO.	0.00		701,038.32	0.00	701,038.32	
56113022002026002049	REHABILITACION DE DRENAJE SANITARIO EN LA PARRACA APATZINGO, EN LA CALLE AMP. PARRACA APATZINGO, EN LA LOC. DE CHILPANCINGO, MUNICIPIO DE CHILPANCINGO DE LOS BRAVO GRO.	0.00		419,202.24	0.00	419,202.24	
56113022002026002050	CONSTRUCCION DE RED DE DRENAJE SANITARIO EN LAS CALLES LAS ORQUIDEAS Y LOS EUCALIPTOS DE LA COLONIA SAN LUCAS, EN LA LOC. DE CHILPANCINGO, MUNICIPIO DE CHILPANCINGO DE LOS BRAVO GRO.	0.00		112,550.15	0.00	112,550.15	
56113022002026002051	REHABILITACION DE RED DE DRENAJE SANITARIO EN LA COLONIA LOMAS DEL PONIENTE, EN LA LOC. DE CHILPANCINGO, MUNICIPIO DE CHILPANCINGO DE LOS BRAVO GRO.	0.00		860,693.49	0.00	860,693.49	

H. Ayuntamiento Municipal Chilpancingo, Gro. SECRETARIA DE FINANZAS Y ADMINISTRACION







H. AYUNTAMIENTO MUNICIPAL DE CHILPANCINGO, GRO.  
SECRETARIA DE FINANZAS Y ADMINISTRACION  
CONSOLIDADO



BALANZA DE COMPROBACION DEL 1 DE ENERO AL 31 DE DICIEMBRE DEL 2019

C U E N T A	C O N C E P T O	SALDOS INICIALES		MOVIMIENTOS		SALDOS ACUMULADOS	
		AL 1 DE ENERO DE 2019		ENERO - DICIEMBRE 2019		AL 31 DE DICIEMBRE DE 2019	
		DEBE	HABER	DEBE	HABER	DEBE	HABER
56113022002026002086	EN LA COLONIA MORELOS, EN LA LOC. DE CHILPANCINGO, MUNICIPIO DE CHILPANCINGO DE LOS BRAVO GRO. CONSTRUCCION DE RED DE AGUA POTABLE EN LAS CALLES 5 DE FEBRERO Y ENCINO, EN LA COLONIA 13 DE JUNIO, EN LA LOC. DE CHILPANCINGO, MUNICIPIO DE CHILPANCINGO DE LOS BRAVO GRO.	0.00		531,076.99	0.00	531,076.99	
56113022002026002087	REHABILITACION DE LINEA DE AGUA POTABLE PARA LA CALLE ENSENADA DEL KM 0+000 AL KM 0+080, EN LA COLONIA MIRADOR, EN LA LOC. DE CHILPANCINGO, MUNICIPIO DE CHILPANCINGO DE LOS BRAVO GRO.	0.00		100,252.05	0.00	100,252.05	
56113022002026002088	CONSTRUCCION DE RED DE DRENAJE SANITARIO EN LA CALLE LAZARO CARDENAS, DE LA COLONIA TIERRA Y LIBERTAD, EN LA LOC. DE CHILPANCINGO, MUNICIPIO DE CHILPANCINGO DE LOS BRAVO GRO.	0.00		451,616.19	0.00	451,616.19	
56113022002026002089	CONSTRUCCION DE RED DE DRENAJE SANITARIO EN LA CALLE ESMERALDA, DE LA COLONIA VILLAS TLAMECAC, EN LA LOC. DE CHILPANCINGO, MUNICIPIO DE CHILPANCINGO DE LOS BRAVO GRO.	0.00		353,470.19	0.00	353,470.19	
56113022002026002090	CONSTRUCCION DE RED DE DRENAJE SANITARIO EN EL ANTIGUO CAMINO A TIXTLA, DE LA COLONIA LA ESPERANZA, EN LA LOC. DE CHILPANCINGO, MUNICIPIO DE CHILPANCINGO DE LOS BRAVO GRO.	0.00		414,044.11	0.00	414,044.11	
56113022002026002091	MEJORAMIENTO EN LA RED DE DRENAJE SANITARIO Y CALLE EN EL ESPACIO PUBLICO DE LAS INSTALACIONES DE LA FERIA DE NAVIDAD Y AÑO NUEVO, EN LA LOC. DE CHILPANCINGO, MUNICIPIO DE CHILPANCINGO DE LOS BRAVO GRO.	0.00		688,266.44	0.00	688,266.44	
56113022002026002092	CONSTRUCCION DE LINEA DE DRENAJE SANITARIO EN LOS ANDADORES, MARGARTAS, CROQUIDEAS, ALCATRAZ Y JAZMIN, DE LA COLONIA PRIMAVERA, EN LA LOC. DE CHILPANCINGO, MUNICIPIO DE CHILPANCINGO DE LOS BRAVO GRO.	0.00		587,574.09	0.00	587,574.09	
56113022002026002093	CONSTRUCCION DE LA BARRANCA JALHUATZINGO, EN LA COLONIA FLORIDA, EN LA LOC. DE CHILPANCINGO, MUNICIPIO DE CHILPANCINGO DE LOS BRAVO GRO.	0.00		678,844.96	0.00	678,844.96	
56113022002026002094	REHABILITACION DE LA RED DE DRENAJE SANITARIO EN LA CALLE VIOLETA, DE LA COLONIA VILLA DE LAS FLORES, EN LA LOC. DE CHILPANCINGO, MUNICIPIO DE CHILPANCINGO DE LOS BRAVO GRO.	0.00		405,707.02	0.00	405,707.02	
56113022002026002095	CONSTRUCCION DE DRENAJE SANITARIO EN LA CALLE AGUA MARINA, DE LA COLONIA PALUDISMO, EN LA LOC. DE CHILPANCINGO,	0.00		398,145.49	0.00	398,145.49	

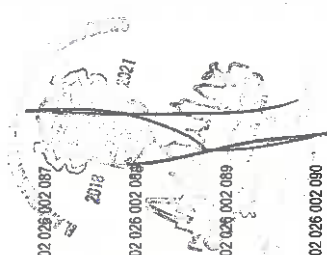



H. AYUNTAMIENTO MUNICIPAL DE CHILPANCINGO, GRO.  
SECRETARIA DE FINANZAS Y ADMINISTRACION

CONSOLIDADO



BALANZA DE COMPROBACION DEL 1 DE ENERO AL 31 DE DICIEMBRE DEL 2019

C U E N T A	C O N C E P T O	SALDOS INICIALES		MOVIMIENTOS		SALDOS ACUMULADOS	
		AL 1 DE ENERO DE 2019		ENERO - DICIEMBRE 2019		AL 31 DE DICIEMBRE DE 2019	
		DEBE	HABER	DEBE	HABER	DEBE	HABER
56113022002026002096	MUNICIPIO DE CHILPANCINGO DE LOS BRAVO GRO. REHABILITACION DE RED DE ALCANTARILLADO SANITARIO Y AGUA POTABLE EN LA CALLE LOS FRESNOS, DE LA COLONIA EL ENCANTO, EN LA LOC. DE CHILPANCINGO, MUNICIPIO DE CHILPANCINGO DE LOS BRAVO GRO.	0.00		145,206.03	0.00	145,206.03	
56113022002026002097	AMPLIACION DE RED DE DRENAJE SANITARIO EN LA CALLE MAURILLO FLORES, DE LA COLONIA LA TRINCHERA, EN LA LOC. DE CHILPANCINGO, MUNICIPIO DE CHILPANCINGO DE LOS BRAVO GRO.	0.00		465,915.96	0.00	465,915.96	
56113022002026002098	AMPLIACION Y PUESTA EN MARCHA DE LA LINEA DE DISTRIBUCION DE AGUA POTABLE EN LA LOC. DE ZOYATEPEC, MUNICIPIO DE CHILPANCINGO DE LOS BRAVO GRO.	0.00		74,233.32	0.00	74,233.32	
56113023	FONDO DE APORTACION PARA EL FORTALECIMIENTO MUNICIPAL	0.00		1,213,894.00	0.00	1,213,894.00	
5611302300A	AGUA POTABLE Y SANEAMIENTO	0.00		1,213,894.00	0.00	1,213,894.00	
5611302300A026	EJERCICIO 2018	0.00		1,213,894.00	0.00	1,213,894.00	
56113023002026002001	CONTRATO REHABILITACION DEL EQUIPAMIENTO ELECTROMECANICO DEL POZO PROFUNDO T1 DEL SISTEMA DE AGUA POTABLE MOCHITLAN, REHABILITACION DE BOMBA SUMERGIBLE PARA UN GASTO DE 35 LPS Y UNA CARGA DINAMICA DE 190 MTS CON DESCARGA DE 6" DE DIAMETRO, ACOPLADA A MOTOR ELECTRICO SUMERGIBLE TRIFASICO DE 125 HP PARA OPERAR A 460 VOLTS 60 HZ MUNICIPIO DE CHILPANCINGO DE LOS BRAVO GUERRERO	0.00		1,906,981.00	0.00	1,906,981.00	
56113032	PROGRAMA PRODDER	0.00		1,906,981.00	0.00	1,906,981.00	
56113032002	AGUA Y SANEAMIENTO	0.00		1,906,981.00	0.00	1,906,981.00	
56113032002026	EJERCICIO 2019	0.00		1,906,981.00	0.00	1,906,981.00	
56113032002026002001	CONTRATO REHABILITACION DEL EQUIPAMIENTO ELECTROMECANICO DEL POZO PROFUNDO M1 DEL SISTEMA DE AGUA POTABLE MOCHITLAN, REHABILITACION DE BOMBA SUMERGIBLE PARA UN GASTO DE 45 LPS Y UNA CARGA DINAMICA TOTAL DE 120 MTS CON DESCARGA DE 8" DE DIAMETRO, ACOPLADA A MOTOR ELECTRICO SUMERGIBLE, TRIFASICO DE 125 HP PARA OPERAR A 460 VOLTS Y 60 HZ, SUMINISTRO DE TUBERIA DE COLUMNA EN ACERO DE 8" DE DIAMETRO CED. 40 CON COPILE A UNA PROFUNDIDAD DE 120 MTS. REHABILITACION DE LINEA DE CONDUCCION DEL SISTEMA DE AGUA POTABLE EL RETAJE.	0.00		656,981.00	0.00	656,981.00	
56113032002026002002		0.00		1,250,000.00	0.00	1,250,000.00	

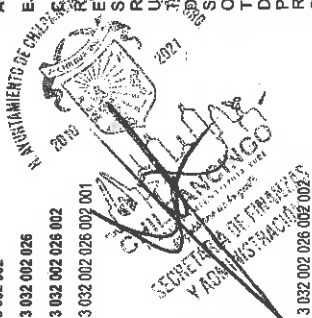

Coram/ Balanza

6.08.08 PM

miércoles 25 marzo 2020





H. AYUNTAMIENTO MUNICIPAL DE CHILPANCINGO, GRO.  
SECRETARIA DE FINANZAS Y ADMINISTRACION

CONSOLIDADO



BALANZA DE COMPROBACIÓN DEL 1 DE ENERO AL 31 DE DICIEMBRE DEL 2019

C U E N T A	C O N C E P T O	SALDOS INICIALES		MOVIMIENTOS		SALDOS ACUMULADOS	
		AL 1 DE ENERO DE 2019		ENERO - DICIEMBRE 2019		AL 31 DE DICIEMBRE DE 2019	
		DEBE	HABER	DEBE	HABER	DEBE	HABER
56113040	SUMINISTRO E INSTALACION DE TUBERIA EN ACERO DE 6" DE DIAMETRO CED. 40	0.00		692,511.17	0.00	692,511.17	
5611304002	COLOCACION DE ATRAQUES DE CONCRETO DE FC=250 KG/CM2 CADA 300 MTS. FABRICACION DE CAJAS DE VALVULAS EN EL MUNICIPIO DE CHILPANCINGO DE LOS BRAVO.	0.00		692,511.17	0.00	692,511.17	
5611304002026	FAEISM	0.00		692,511.17	0.00	692,511.17	
5611304002026001	AGUA Y SANEAMIENTO	0.00		692,511.17	0.00	692,511.17	
5611304002026001001	EJERCICIO 2019	0.00		692,511.17	0.00	692,511.17	
5611304002026001001001	CONTRATO	0.00		692,511.17	0.00	692,511.17	
56114022	REHABILITACION DEL EQUIPAMIENTO ELECTROMECANICO DEL POZO PROFUNDO M1	0.00		110,293,504.18	15,442,297.14	94,851,207.04	
56114022001	SEL SISTEMA DE AGUA POTABLE MOCHITLAN	0.00		94,185,002.69	8,037,990.14	86,147,012.55	
56114022001026	REHABILITACION DE BOMBA SUMERGIBLE PARA UN GASTO DE 45 LPS Y UNA CARGA DINAMICA TOTAL DE 120 MTS CON DESCARGA DE 8" DE DIAMETRO, ACOPLADA A MOTOR ELECTRICO SUMERGIBLE, TRIFASICO DE 125 HP PARA OPERAR A 460 VOLTS Y 60 HZ. SUMINISTRO DE TUBERIA DE COLUMNA EN ACERO DE 8" DE DIAMETRO CED. 40 CON COPLE A UNA PROFUNDIDAD DE 120 MTS.	0.00		93,779,327.93	8,037,990.14	85,741,337.79	
56114022001026002	DIVISION DE TERRENOS Y CONSTRUCCION DE OBRAS DE URBANIZACION	0.00		93,779,327.93	8,037,990.14	85,741,337.79	
56114022001026002001	FAISM RAMO XXXIII	0.00		93,779,327.93	8,037,990.14	85,741,337.79	
56114022001026002001001	EJERCICIO 2019	0.00		93,779,327.93	8,037,990.14	85,741,337.79	
56114022001026002001001001	CONTRATO	0.00		93,779,327.93	8,037,990.14	85,741,337.79	
56114022001026002001001001001	CONSTRUCCION DE PUENTE VEHICULAR UN CARRIL EN LA LOCALIDAD DE PALO BLANCO MUNICIPIO DE CHILPANCINGO DE LOS BRAVO, ESTADO DE GUERRERO.	0.00		1,250,369.39	0.00	1,250,369.39	
56114022001026002001001001001001	REHABILITACION CON CONCRETO HIDRAULICO DE LA AV. RUFFO FIGUEROA Y AV. LAZARO CARDENAS, DE LA COL. BUROCRATAS, DE CHILPANCINGO DE LOS BRAVO, ESTADO DE GUERRERO.	0.00		360,373.57	0.00	360,373.57	
56114022001026002001001001001001001	RASTREO DE CAMINO RURAL : CRUCERO COL LA CINCA - NUEVO MIRADOR, DE CHILPANCINGO DE LOS BRAVO, ESTADO DE GUERRERO	0.00		138,163.52	0.00	138,163.52	
56114022001026002001001001001001001001	PAVIMENTACION CON CONCRETO HIDRAULICO DE LA AV. VICENTE GUERRERO, ENTRE PUENTE PEATONAL-CALLE GABRIEL LEYVA, COLONIA DEL FRI DE LA CIUDAD DE CHILPANCINGO DE LOS BRAVO GUERRERO	0.00		1,321,362.18	0.00	1,321,362.18	
56114022001026002001001001001001001001001	CONSTRUCCION DE MURO DE CONTENCIÓN EN LA COL. SAN JOSE, DE CHILPANCINGO DE LOS BRAVO, GUERRERO.	0.00		981,056.64	0.00	981,056.64	

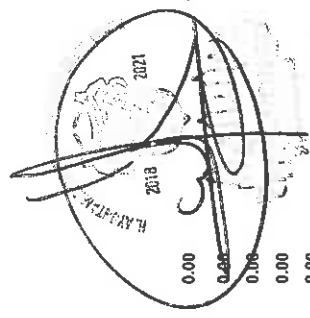

H. Ayuntamiento Municipal Chilpancingo  
SECRETARIA DE FINANZAS Y ADMINISTRACION  
CONTRALORIA INTERNA



H. AYUNTAMIENTO MUNICIPAL DE CHILPANCINGO, GRO.  
SECRETARIA DE FINANZAS Y ADMINISTRACION

CONSOLIDADO



BALANZA DE COMPROBACIÓN DEL 1 DE ENERO AL 31 DE DICIEMBRE DEL 2019

C U E N T A	C O N C E P T O	SALDOS INICIALES		M O V I M I E N T O S		SALDOS ACUMULADOS	
		AL 1 DE ENERO DE 2019		ENERO - DICIEMBRE 2019		AL 31 DE DICIEMBRE DE 2019	
		DEBE	HABER	DEBE	HABER	DEBE	HABER
56114022001026002006	REHABILITACIÓN DEL PAVIMENTO CON MEZCLA ASFÁLTICA EN CALIENTE DE LAS CALLES ANTONIA NAVA DE CATALÁN DEL BARRIO DE SAN FRANCISCO, JUAN N. ALVAREZ DE LA COL. CENTRO Y DE LAS CALLES GONZALO N. RAMÍREZ CONSTITUCIÓN POLÍTICA Y AVENIDA DEL SOL, DE LAS COL. TRIBUNA NACIONAL Y HACIENDITA II, DE CHILPANCINGO DE LOS BRAVO, ESTADO DE GUERRERO.	0.00		1,066,568.09	0.00	1,066,568.09	
56114022001026002007	REHABILITACIÓN CON MEZCLA ASFÁLTICA EN CALIENTE, EN CARRILES LATERALES DEL BOULEVARD VICENTE GUERRERO, ENTRE LAS CALLES 1RA DE LA COL. DEL PRI Y CENTRO ESCOLAR VICENTE GUERRERO, DE CHILPANCINGO DE LOS BRAVO, ESTADO DE GUERRERO.	0.00		1,337,223.58	0.00	1,337,223.58	
56114022001026002008	REHABILITACIÓN CON MEZCLA ASFÁLTICA DEL ACCESO PRINCIPAL DE LA LOCALIDAD DE ACAHUIZOTLA, MPIO. DE CHILPANCINGO DE LOS BRAVO, ESTADO DE GUERRERO.	0.00		663,694.07	0.00	663,694.07	
56114022001026002009	CONSTRUCCIÓN DE ALBERGUE EN LA COMUNIDAD DE SAN MIGUEL, MPIO. DE CHILPANCINGO DE LOS BRAVO, ESTADO DE GUERRERO.	0.00		955,162.34	0.00	955,162.34	
56114022001026002010	CONSTRUCCIÓN DE ALEROS PARA ACCESOS DE ENTRADA Y SALIDA DEL PUENTE VEHICULAR EL ASERRADERO, EN LA LOCALIDAD DE JALEACA DE LOS BRAVO, ESTADO DE GUERRERO.	0.00		1,478,517.82	0.00	1,478,517.82	
56114022001026002011	PASTOREO DE CAMINO RURAL: CRUCERO PIEDRA NEGRA -LA ESPERANZA EN EL MUNICIPIO DE CHILPANCINGO DE LOS BRAVO, EN EL ESTADO DE GUERRERO.	0.00		500,000.00	0.00	500,000.00	
56114022001026002012	RÁSTREO DE CAMINO RURAL: AZINYAHUALCO - ZORATREC EN EL MUNICIPIO DE CHILPANCINGO DE LOS BRAVO, EN EL ESTADO DE GUERRERO.	0.00		400,000.00	0.00	400,000.00	
56114022001026002013	PAVIMENTACIÓN DEL CAMINO OCOTITIL-TLAHUZAPA-COACOYULILLO-JALEACA DE CATALÁN, MUNICIPIO DE CHILPANCINGO Y E.C. (CHILPANCINGO-AMOJILECA) - COAPANGO-HUACALAPA-EL FRESNO (CONVENIO DE COORDINACION CON CICAEG)	0.00		7,500,000.00	7,500,000.00	0.00	0.00
56114022001026002014	PAVIMENTACION CON CONCRETO HIDRAULICO DE LA AV EJERCITO NACIONAL COLONIA PROGRESO, LOC DE CHILPANCINGO, MUNICIPIO DE CHILPANCINGO DE LOS BRAVO GRO. (CONVENIO CICAEG)	0.00		1,364,077.85	0.00	1,364,077.85	
56114022001026002015	CONSTRUCCIÓN DE LOS ACCESOS AL PUENTE VEHICULAR UN CARRIL EN LA LOC. DE PALO BLANCO, MPIO DE CHILPANCINGO DE LOS BRAVO, ESTADO DE GUERRERO	0.00		1,595,284.36	0.00	1,595,284.36	
56114022001026002016	PAVIMENTACION CON CONCRETO HIDRAULICO DE LA CALLE VICENTE LOMBARDO TOLEDANO Y	0.00		2,373,546.74	0.00	2,373,546.74	

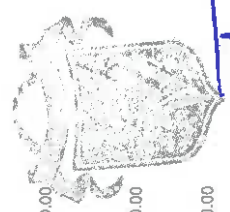
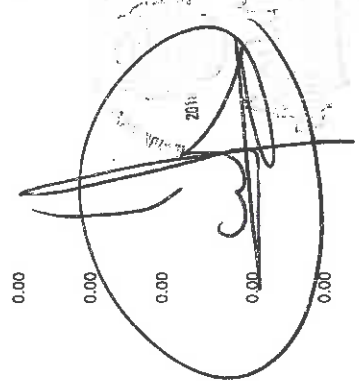
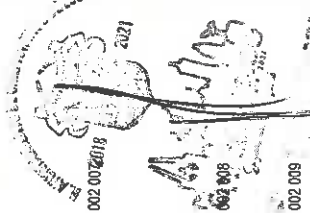

H. Ayuntamiento Municipal de Chilpancingo, Gro.  
CONTRALORIA MUNICIPAL



H. AYUNTAMIENTO MUNICIPAL DE CHILPANCINGO, GRO.  
SECRETARIA DE FINANZAS Y ADMINISTRACION  
CONSOLIDADO



BALANZA DE COMPROBACIÓN DEL 1 DE ENERO AL 31 DE DICIEMBRE DEL 2019

C U E N T A	C O N C E P T O	SALDOS INICIALES		M O V I M I E N T O S		SALDOS ACUMULADOS	
		AL 1 DE ENERO DE 2019		ENERO - DICIEMBRE 2019		AL 31 DE DICIEMBRE DE 2019	
		DEBE	HABER	DEBE	HABER	DEBE	HABER
56114022001026002017	ALTAMIRANO EN LAS COL. COOPERATIVA DE VIVIENDA Y MARGARITA VIGURI, LOC DE CHILPANCINGO, MUNICIPIO DE CHILPANCINGO DE LOS BRAVO GRO. (CONVENIO CICAEG) PAVIMENTACION CON CONCRETO HIDRAULICO DEL ACCESO A LA COLONIA CNOP SECCION B, CALLE MIRADOR TRAMO: CALLE ATALAYA-CALLE FERNANDO LOPEZ, LOC. DE CHILPANCINGO, MUNICIPIO DE CHILPANCINGO DE LOS BRAVO GRO. (CONVENIO CICAEG)	0.00		759,475.89	0.00	759,475.89	
56114022001026002018	PAVIMENTACION CON CONCRETO HIDRAULICO DE LA CALLE MARISCAL GALEANA COL. HERMENEGILDO GALEANA, LOC. DE CHILPANCINGO, MUNICIPIO DE CHILPANCINGO DE LOS BRAVO GRO. (CONVENIO CICAEG)	0.00		1,793,569.63	0.00	1,793,569.63	
56114022001026002019	PAVIMENTACION CON CONCRETO HIDRAULICO TRAMO LATERAL DE LA AV. INSURGENTES, CALLE 18 DE JULIO Y CALLE LUCIA ALCOCER COL. BENITO JUAREZ Y MORELOS, LOC. DE CHILPANCINGO, GRO. MUNICIPIO DE CHILPANCINGO DE LOS BRAVO. (CONVENIO CICAEG)	0.00		891,731.08	0.00	891,731.08	
56114022001026002020	PAVIMENTACION CON CONCRETO HIDRAULICO DE LA CALLE CONSTRUCTORES TRAMO.-AV. SOBORNADORES-ANDADOR 1, FRACC. PENSADORES, LOC DE CHILPANCINGO, MUNICIPIO DE CHILPANCINGO DE LOS BRAVO GRO. (CONVENIO CICAEG)	0.00		1,229,195.48	0.00	1,229,195.48	
56114022001026002021	PAVIMENTACION CON CONCRETO HIDRAULICO PRIMERA ETAPA DE LA CALLE TULIPANES COL. INDEO Y LOS SAUCES, LOC DE CHILPANCINGO, MUNICIPIO DE CHILPANCINGO DE LOS BRAVO GRO. (CONVENIO CICAEG)	0.00		1,209,473.10	0.00	1,209,473.10	
56114022001026002022	PRIMERA ETAPA DE LA CALLE PROSPERIDAD COL UNIVERSAL, LOC. DE CHILPANCINGO, MUNICIPIO DE CHILPANCINGO DE LOS BRAVO GRO. (CONVENIO CICAEG)	0.00		1,135,492.97	0.00	1,135,492.97	
56114022001026002024	PAVIMENTACION CON CONCRETO HIDRAULICO DE LA CALLE REAL, TRAMO BARRANCA CHUCHUYULUYA LUIS DONALDO COLOSIO, COL. HERMENEGILDO GALEANA, LOC. DE CHILPANCINGO, MUNICIPIO DE CHILPANCINGO DE LOS BRAVO GRO. (CONVENIO CICAEG)	0.00		1,142,275.72	0.00	1,142,275.72	
56114022001026002025	PAVIMENTACION CON CONCRETO HIDRAULICO DE LA CALLE ALTAMIRANO EN LA COL MARGARITA VIGURI, LOC DE CHILPANCINGO, MUNICIPIO DE CHILPANCINGO DE LOS BRAVO. (CONVENIO CICAEG)	0.00		2,002,508.86	0.00	2,002,508.86	
56114022001026002025	CONSTRUCCION DE ACCESO A LAS COLONIAS AQUILES Y MARTIRES ANTORCHISTA, LOC DE CHILPANCINGO, MUNICIPIO DE CHILPANCINGO DE LOS BRAVO. (CONVENIO CICAEG)	0.00		1,452,525.07	447,351.63	1,005,173.44	

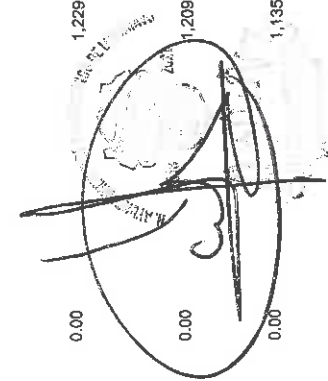

SECRETARIA DE FINANZAS Y ADMINISTRACION  
CONTRALORIA INTERNA MUNICIPAL



H. AYUNTAMIENTO MUNICIPAL DE CHILPANCINGO, GRO.

SECRETARIA DE FINANZAS Y ADMINISTRACION

CONSOLIDADO



BALANZA DE COMPROBACIÓN DEL 1 DE ENERO AL 31 DE DICIEMBRE DEL 2019

C U E N T A	C O N C E P T O	SALDOS INICIALES		MOVIMIENTOS		SALDOS ACUMULADOS	
		AL 1 DE ENERO DE 2019		ENERO - DICIEMBRE 2019		AL 31 DE DICIEMBRE DE 2019	
		DEBE	HABER	DEBE	HABER	DEBE	HABER
55114022001026002026	ESTADO DE GUERRERO. CONSTRUCCIÓN DE PAVIMENTO CON CONCRETO HIDRAULICO EN LA CALLE: ROSARIO IBARRA, TRAMO: CALLE GENARO VAZQUEZ - CALLE AMALIA GARCIA MEDINA DE LA COLONIA PRD, LOC. DE CHILPANCINGO, MUNICIPIO DE CHILPANCINGO DE LOS BRAVO.	0.00		1,376,405.97	0.00	1,376,405.97	
55114022001026002027	CONSTRUCCIÓN DE PAVIMENTO CON CONCRETO HIDRAULICO EN EL ANDADOR No.2, DE LA COLONIA SAN ANGEL, LOC. DE CHILPANCINGO, MUNICIPIO DE CHILPANCINGO DE LOS BRAVO.	0.00		550,124.36	0.00	550,124.36	
55114022001026002028	CONSTRUCCIÓN DE MURO DE CONTENCIÓN EN LA BARRANCA EL HUIZACHAL EN LA CALLE CEIBAS, DE LA COLONIA HACIENDITA, LOC. DE CHILPANCINGO, MUNICIPIO DE CHILPANCINGO DE LOS BRAVO.	0.00		293,822.79	0.00	293,822.79	
55114022001026002029	CONSTRUCCIÓN DE CANCHA DEPORTIVA EN LA LOC. DE RINCON DE ALCAPARROSA, MUNICIPIO DE CHILPANCINGO DE LOS BRAVO.	0.00		547,854.09	0.00	547,854.09	
55114022001026002030	CONSTRUCCIÓN DE PAVIMENTO CON CONCRETO HIDRAULICO EN EL ANDADOR No.2 DE LA COLONIA LA TRINCHERA, DE LA LOC. DE CHILPANCINGO, MUNICIPIO DE CHILPANCINGO DE LOS BRAVO.	0.00		986,322.12	0.00	986,322.12	
55114022001026002031	CONSTRUCCIÓN DE PAVIMENTO CON CONCRETO HIDRAULICO EN EL ACCESO PRINCIPAL A LA COLONIA POTRERITO, TRAMO: KM 0+000 AL KM 0+124 DE LA LOC. DE CHILPANCINGO, MUNICIPIO DE CHILPANCINGO DE LOS BRAVO.	0.00		872,752.27	0.00	872,752.27	
55114022001026002032	REHABILITACIÓN DE CAMINO RURAL - JALEACA DE CANTALAN - LA CUMBRE, TRAMO: KM 0+000 AL KM M+500 DE MUNICIPIO DE CHILPANCINGO DE LOS BRAVO.	0.00		905,680.00	0.00	905,680.00	
55114022001026002033	REHABILITACIÓN DE CAMINO RURAL: EL SALITRE - EL CRUCELAR, TRAMO: KM 0+000 AL KM 20+000, MUNICIPIO DE CHILPANCINGO DE LOS BRAVO.	0.00		609,342.00	0.00	609,342.00	
55114022001026002034	CONSTRUCCIÓN DE PAVIMENTO CON CONCRETO HIDRAULICO EN LA CALLE BUGAMBILIAS, TRAMO: KM 0+000 AL KM 0+085, EN LA COLONIA 20 DE MAYO EN LA LOC. DE PETAQUILLAS, MUNICIPIO DE CHILPANCINGO DE LOS BRAVO.	0.00		735,474.05	0.00	735,474.05	
55114022001026002035	REHABILITACIÓN DE PAVIMENTO CON MEZCLA ASFALTICA EN DIVERSAS CALLES DEL MUNICIPIO DE CHILPANCINGO DE LOS BRAVO.	0.00		341,702.87	0.00	341,702.87	
55114022001026002036	REHABILITACIÓN DE PAVIMENTO CON CONCRETO HIDRAULICO EN DIVERSAS CALLES DEL MUNICIPIO DE CHILPANCINGO DE LOS BRAVO.	0.00		254,161.34	0.00	254,161.34	
55114022001026002037	CONSTRUCCIÓN DE MURO DE CONTENCIÓN EN LA COLONIA LAS PALMAS, EN LA LOC. DE CHILPANCINGO, MUNICIPIO DE CHILPANCINGO DE LOS BRAVO.	0.00		1,317,780.06	0.00	1,317,780.06	

2021

SECRETARIA DE FINANZAS Y ADMINISTRACION

CHILPANCINGO

6.08.08 PM

6.08.08 PM

6.08.08 PM

6.08.08 PM



H. AYUNTAMIENTO MUNICIPAL DE CHILPANCINGO, GRO.

SECRETARIA DE FINANZAS Y ADMINISTRACION

CONSOLIDADO



BALANZA DE COMPROBACION DEL 1 DE ENERO AL 31 DE DICIEMBRE DEL 2019

C U E N T A	C O N C E P T O	SALDOS INICIALES		MOVIMIENTOS		SALDOS ACUMULADOS	
		AL 1 DE ENERO DE 2019		ENERO - DICIEMBRE 2019		AL 31 DE DICIEMBRE DE 2019	
		DEBE	HABER	DEBE	HABER	DEBE	HABER
5 6 1 1 4 0 2 2 0 0 1 0 2 6 0 0 2 0 3 8	CONSTRUCCION DE PUENTE PEATONAL EN LA BARRANCA DE JALAHUATZINGO EN LA COLONIA GUERRERO, EN LA LOC. DE CHILPANCINGO, MUNICIPIO DE CHILPANCINGO DE LOS BRAVO.	0.00	0.00	84,284.81	0.00	84,284.81	
5 6 1 1 4 0 2 2 0 0 1 0 2 6 0 0 2 0 3 9	CONSTRUCCION DE PAVIMENTO CON CONCRETO HIDRAULICO DE LA CALLE PROFESORA MA. ISABEL LEYVA MANGUILLA, EN EL PRACIONAMIENTO VILLAS DE LEYVA, EN LA LOC. DE CHILPANCINGO, MUNICIPIO DE CHILPANCINGO DE LOS BRAVO.	0.00	0.00	707,324.63	0.00	707,324.63	
5 6 1 1 4 0 2 2 0 0 1 0 2 6 0 0 2 0 4 1	MEJORAMIENTO DE CALLES CON REVESTIMIENTO EN LA CIUDAD DE CHILPANCINGO, MUNICIPIO DE CHILPANCINGO DE LOS BRAVO.	0.00	0.00	1,290,128.00	0.00	1,290,128.00	
5 6 1 1 4 0 2 2 0 0 1 0 2 6 0 0 2 0 4 2	CONSTRUCCION DEL PAVIMENTO CON CONCRETO HIDRAULICO EN LA CALLE AV. ARQUITECTURA, TRAMO: CALLE RENE JUAREZ CISNEROS-CALLE INGENIERIA, DE LA COLONIA REFORMA UNIVERSITARIA, EN LA LOC. DE CHILPANCINGO, MUNICIPIO DE CHILPANCINGO DE LOS BRAVO.	0.00	0.00	863,336.93	0.00	863,336.93	
5 6 1 1 4 0 2 2 0 0 1 0 2 6 0 0 2 0 4 3	CONSTRUCCION DEL PAVIMENTO CON CONCRETO HIDRAULICO EN LA CALLE JOSE MARIA MORELOS Y PAVON, DE LA COLONIA 16 DE SEPTIEMBRE, EN LA LOC. DE CHILPANCINGO, MUNICIPIO DE CHILPANCINGO DE LOS BRAVO.	0.00	0.00	938,610.69	0.00	938,610.69	
5 6 1 1 4 0 2 2 0 0 1 0 2 6 0 0 2 0 4 4	CONSTRUCCION DEL PAVIMENTO CON CONCRETO HIDRAULICO EN LA CALLE PROF. ENRIQUE CABRERA TRAMO: ANDADOR PROF. LUCIGABANAS BARRIENTOS-CALLE JANITZIO, EN LA COLONIA UNIDAD MAGISTERIAL, EN LA LOC. DE CHILPANCINGO, MUNICIPIO DE CHILPANCINGO DE LOS BRAVO.	0.00	0.00	695,662.15	0.00	695,662.15	
5 6 1 1 4 0 2 2 0 0 1 0 2 6 0 0 2 0 4 5	REHABILITACION DEL PAVIMENTO CON CONCRETO HIDRAULICO EN LA CALLE ENSENADA TRAMO: KM 0+000 AL KM 0+080, EN LA COLONIA EL MIRADOR, EN LA LOC. DE CHILPANCINGO, MUNICIPIO DE CHILPANCINGO DE LOS BRAVO.	0.00	0.00	525,504.02	0.00	525,504.02	
5 6 1 1 4 0 2 2 0 0 1 0 2 6 0 0 2 0 4 6	CONSTRUCCION DEL PAVIMENTO CON CONCRETO HIDRAULICO EN LA CALLE NINFA TRAMO: KM 0+000-CALLE PRIMERA, EN LA COLONIA VALLE DORADO, EN LA LOC. DE CHILPANCINGO, MUNICIPIO DE CHILPANCINGO DE LOS BRAVO.	0.00	0.00	969,523.01	0.00	969,523.01	
5 6 1 1 4 0 2 2 0 0 1 0 2 6 0 0 2 0 4 7	CONSTRUCCION DEL PAVIMENTO CON CONCRETO HIDRAULICO EN LA CALLE FRANCISCO VILLA TRAMO: CALLE ENCINO-CALLE ALAMOS, DE LA COLONIA EMILIANO ZAPATA, EN LA LOC. DE CHILPANCINGO, MUNICIPIO DE CHILPANCINGO DE LOS BRAVO.	0.00	0.00	854,866.21	0.00	854,866.21	
5 6 1 1 4 0 2 2 0 0 1 0 2 6 0 0 2 0 4 8	CONSTRUCCION DEL PAVIMENTO CON CONCRETO HIDRAULICO EN LA CALLE EMILIANO ZAPATA, DE LA COLONIA FRANCISCO VILLA, EN	0.00	0.00	1,075,662.30	0.00	1,075,662.30	

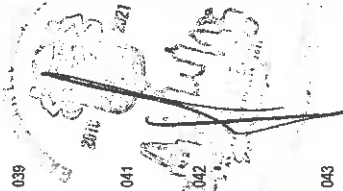





H. AYUNTAMIENTO MUNICIPAL DE CHILPANCINGO, GRO.

SECRETARIA DE FINANZAS Y ADMINISTRACION

CONSOLIDADO



BALANZA DE COMPROBACIÓN DEL 1 DE ENERO AL 31 DE DICIEMBRE DEL 2019

C U E N T A	C O N C E P T O	SALDOS INICIALES		MOVIMIENTOS		SALDOS ACUMULADOS		
		AL 1 DE ENERO DE 2019		ENERO - DICIEMBRE 2019		AL 31 DE DICIEMBRE DE 2019		
		DEBE	HABER	DEBE	HABER	DEBE	HABER	
56114022001026002049	LA LOC. DE CHILPANCINGO, MUNICIPIO DE CHILPANCINGO DE LOS BRAVO. CONSTRUCCION DEL PAVIMENTO CON CONCRETO HIDRAULICO EN LA CALLE JOSE MARIA MORELOS TRAMO: CALLE REVOLUCION CALLE MEXICO, EN LA COLONIA PLUTARCO ELIAS CALLES, EN LA LOC. DE CHILPANCINGO, MUNICIPIO DE CHILPANCINGO DE LOS BRAVO. CONSTRUCCION DE PAVIMENTO CON CONCRETO HIDRAULICO EN LA CALLE BENITO JUAREZ TRAMO: KM 0+000 AL KM 0+100, EN LA COLONIA MEXICO, EN LA LOC. DE CHILPANCINGO, MUNICIPIO DE CHILPANCINGO DE LOS BRAVO. CONSTRUCCION DE PAVIMENTO CON CONCRETO HIDRAULICO EN LA CALLE DURANGO TRAMO: KM 0+000 AL KM 0+150, EN LA COLONIA TERRERO, EN LA LOC. DE CHILPANCINGO, MUNICIPIO DE CHILPANCINGO DE LOS BRAVO. CONSTRUCCION DE PAVIMENTO CON CONCRETO HIDRAULICO EN LA CALLE VICENTE GUERRERO TRAMO: KM 0+000 AL KM 0+080, EN LA COLONIA MIGUEL HIDALGO, EN LA LOC. DE CHILPANCINGO, MUNICIPIO DE CHILPANCINGO DE LOS BRAVO. CONSTRUCCION DE PAVIMENTO CON CONCRETO HIDRAULICO EN LA CALLE VICENTE GUERRERO, EN LA COLONIA INDEPENDENCIA, EN LA LOC. DE CHILPANCINGO, MUNICIPIO DE CHILPANCINGO DE LOS BRAVO. CONSTRUCCION DE PAVIMENTO CON CONCRETO HIDRAULICO EN LA CALLE CARITINO MALDONADO TRAMO: CALLE FELICIANO DOMINGUEZ-CALLE BEVERIANO RODRIGUEZ, EN LA COLONIA PLAN DE AYALA, EN LA LOC. DE CHILPANCINGO, MUNICIPIO DE CHILPANCINGO DE LOS BRAVO. CONSTRUCCION DE PAVIMENTO CON CONCRETO HIDRAULICO EN LA CALLE GONZALO ALARCON ADAME TRAMO: KM 0+156 AL KM 0+286, EN LA COLONIA IXQUIAPA, EN LA LOC. DE CHILPANCINGO, MUNICIPIO DE CHILPANCINGO DE LOS BRAVO. REHABILITACION DE CAMINO RURAL: CRUCERO DEL MATADERO - HELIODORO CASTILLO (CHICAHUALES), MUNICIPIO DE CHILPANCINGO DE LOS BRAVO. REHABILITACION DE CAMINO RURAL: TRAMO: COAPANGO - EL FRESNO, MUNICIPIO DE CHILPANCINGO DE LOS BRAVO. CONSTRUCCION DE MURO DE CONTENCIÓN EN EL CIRCUITO BENITO JUAREZ, EN LA COLONIA AMPLIACION INDEPENDENCIA, EN LA LOC. DE CHILPANCINGO, MUNICIPIO DE CHILPANCINGO DE LOS BRAVO. REHABILITACION DEL PAVIMENTO CON MEZCLA	0.00	0.00	384,199.89	0.00	384,199.89	0.00	384,199.89
56114022001026002050		0.00	647,599.71	0.00	647,599.71	0.00	647,599.71	
56114022001026002051		0.00	914,165.90	0.00	914,165.90	0.00	914,165.90	
56114022001026002052		0.00	504,203.44	0.00	504,203.44	0.00	504,203.44	
56114022001026002053		0.00	281,141.45	0.00	281,141.45	0.00	281,141.45	
56114022001026002054		0.00	555,721.93	0.00	555,721.93	0.00	555,721.93	
56114022001026002055		0.00	802,257.59	0.00	802,257.59	0.00	802,257.59	
56114022001026002057		0.00	376,840.51	0.00	376,840.51	0.00	376,840.51	
56114022001026002058		0.00	574,827.15	0.00	574,827.15	0.00	574,827.15	
56114022001026002059		0.00	969,826.79	0.00	969,826.79	0.00	969,826.79	
56114022001026002059	Corram/ Balanza	0.00	695,262.48	0.00	695,262.48	0.00	695,262.48	



Ayuntamiento Municipal Chilpancingo  
CONTRALORIA R.F.T.E. MUNICIPAL

6.08.08 PM

miércoles 25 marzo 2020



H. AYUNTAMIENTO MUNICIPAL DE CHILPANCINGO, GRO.

SECRETARIA DE FINANZAS Y ADMINISTRACION

CONSOLIDADO



BALANZA DE COMPROBACIÓN DEL 1 DE ENERO AL 31 DE DICIEMBRE DEL 2019

C U E N T A	C O N C E P T O	SALDOS INICIALES		M O V I M I E N T O S		SALDOS ACUMULADOS	
		AL 1 DE ENERO DE 2019		ENERO - DICIEMBRE 2019		AL 31 DE DICIEMBRE DE 2019	
		DEBE	HABER	DEBE	HABER	DEBE	HABER
56114022001026002060	ASFALTICA EN LA AVENIDA VICENTE GUERRERO, TRAMO: CALLE MOISES GUEVARA-CALLE 21 DE MARZO, DE LA COLONIA BENITO JUAREZ Y EN LA AVENIDA TOMA DE OAYACA TRAMO/AV. INSURGENTES-AV. VICENTE GUERRERO EN LA COLONIA HERMENEGILDO GALEANA, EN LA LOC. DE CHILPANCINGO. MUNICIPIO DE CHILPANCINGO DE LOS BRAVO.	0.00		986,303.94	0.00	986,303.94	
56114022001026002061	CONSTRUCCION DE PAVIMENTO CON CONCRETO HIDRAULICO DE LA CALLE GUERRERO, TRAMO: ALLEMADERO-CALLE JUAN N. ALVAREZ, EN LA LOC. DE MAZATLAN. MUNICIPIO DE CHILPANCINGO DE LOS BRAVO.	0.00		827,123.50	0.00	827,123.50	
56114022001026002062	CONSTRUCCION DE PAVIMENTO CON CONCRETO HIDRAULICO DE LA CALLE REVOLUCION DEL SUR, TRAMO: AV. VICENTE GUERRERO A LA CALLE 13 DE SEPTIEMBRE, EN LA COLONIA MORELOS, LOC. DE CHILPANCINGO. MUNICIPIO DE CHILPANCINGO DE LOS BRAVO.	0.00		1,481,640.13	0.00	1,481,640.13	
56114022001026002063	CONSTRUCCION DE PAVIMENTO CON CONCRETO HIDRAULICO EN LA CALLE JACARANDAS, TRAMO: KM 0+000 AL KM 0+100, EN LA COLONIA ASOCIACION CIVIL D-IIIZ, LOC. DE CHILPANCINGO. MUNICIPIO DE CHILPANCINGO DE LOS BRAVO.	0.00		1,054,793.64	0.00	1,054,793.64	
56114022001026002064	CONSTRUCCION DE PAVIMENTO CON CONCRETO HIDRAULICO EN EL ANDADOR ORQUIDEA, DE LA COLONIA RICARDO FLORES MAGON, LOC. DE CHILPANCINGO. MUNICIPIO DE CHILPANCINGO DE LOS BRAVO.	0.00		747,912.27	0.00	747,912.27	
56114022001026002065	CONSTRUCCION DE PAVIMENTO CON CONCRETO HIDRAULICO EN LA CALLE MERCURIO, DE LA COLONIA VILLAS CAMINO SUR, LOC. DE CHILPANCINGO. MUNICIPIO DE CHILPANCINGO DE LOS BRAVO.	0.00		394,587.21	0.00	394,587.21	
56114022001026002067	CONSTRUCCION DE PAVIMENTO CON CONCRETO HIDRAULICO EN LA CALLE MARTIRES DEL 2 DE MAYO, TRAMO: AV. CUAUHTEMOC-CALLE MINOS HEROES, EN LA LOC. DE MAZATLAN. MUNICIPIO DE CHILPANCINGO DE LOS BRAVO.	0.00		799,873.10	0.00	799,873.10	
56114022001026002068	CONSTRUCCION DE PAVIMENTO CON CONCRETO HIDRAULICO EN LA CALLE FRANCISCO GONZALEZ BOCANEGRA, TRAMO: CALLE FCO JAVIER CLAVIERO-CALLE NETZAHUALCOYOTL, DE LA COLONIA OBRERA, EN LA LOC. DE CHILPANCINGO. MUNICIPIO DE CHILPANCINGO DE LOS BRAVO.	0.00		1,253,560.21	0.00	1,253,560.21	
56114022001026002068	CONSTRUCCION DE PAVIMENTO CON CONCRETO HIDRAULICO EN LA CALLE PROF. LUCIO	0.00		527,330.51	0.00	527,330.51	





H. AYUNTAMIENTO MUNICIPAL DE CHILPANCINGO, GRO.  
SECRETARIA DE FINANZAS Y ADMINISTRACION  
CONSOLIDADO



BALANZA DE COMPROBACION DEL 1 DE ENERO AL 31 DE DICIEMBRE DEL 2019

C U E N T A	C O N C E P T O	SALDOS INICIALES		MOVIMIENTOS		SALDOS ACUMULADOS	
		AL 1 DE ENERO DE 2019		ENERO - DICIEMBRE 2019		AL 31 DE DICIEMBRE DE 2019	
		DEBE	HABER	DEBE	HABER	DEBE	HABER
56114022001026002069	CABAÑAS, DE LA COLONIA UNIDAD MAGISTERIAL, EN LA LOC. DE CHILPANCINGO, MUNICIPIO DE CHILPANCINGO DE LOS BRAVO. CONSTRUCCION DE PAVIMENTO CON CONCRETO HIDRAULICO EN LA CALLE ITZCOATL TRAMO: CALLE ACAMAPICHTL-CALLE TIZOC, EN EL FRACCIONAMIENTO AZTECAS, EN LA LOC. DE CHILPANCINGO, MUNICIPIO DE CHILPANCINGO DE LOS BRAVO.	0.00		995,553.74		0.00	995,553.74
56114022001026002070	CONSTRUCCION DE PAVIMENTO CON CONCRETO HIDRAULICO EN LA CALLE MIGUEL HIDALGO, DE LA COLONIA ANTORCHA POPULAR, EN LA LOC. DE CHILPANCINGO, MUNICIPIO DE CHILPANCINGO DE LOS BRAVO.	0.00		1,155,344.13		0.00	1,155,344.13
56114022001026002071	REHABILITACION DE CAMINO RURAL TRAMO: CRUCERO PIEDRA LIADA-LA ESPERANZA, MUNICIPIO DE CHILPANCINGO DE LOS BRAVO.	0.00		842,758.95		0.00	842,758.95
56114022001026002072	REHABILITACION DE CAMINO RURAL TRAMO: SANTA BARBARA-JALEACA DE CATALAN, MUNICIPIO DE CHILPANCINGO DE LOS BRAVO.	0.00		694,293.99		0.00	694,293.99
56114022001026002073	REHABILITACION DE CAMINO RURAL TRAMO: CRUCERO INSCUINATOC-CARRIZAL DE PINZON-SANTA RITA, MUNICIPIO DE CHILPANCINGO DE LOS BRAVO.	0.00		345,954.05		0.00	345,954.05
56114022001026002074	REHABILITACION DE CAMINO RURAL TRAMO: SANTA BARBARA-SANTA RITA, MUNICIPIO DE CHILPANCINGO DE LOS BRAVO.	0.00		226,659.55		0.00	226,659.55
56114022001026002075	REHABILITACION DE CAMINO RURAL TRAMO: SAN FRANCISCO-RIO VERDE, MUNICIPIO DE CHILPANCINGO DE LOS BRAVO.	0.00		868,253.41		0.00	868,253.41
56114022001026002076	REHABILITACION DE CAMINO RURAL TRAMO: OMITLENC-HAUTIPAN-JALEACA DE CATALAN, MUNICIPIO DE CHILPANCINGO DE LOS BRAVO.	0.00		524,895.80		0.00	524,895.80
56114022001026002077	REHABILITACION DE CAMINO RURAL TRAMO: CHILPANCINGO-LLANOS DE TEPOXTEPEC-CHACUALCINGO, MUNICIPIO DE CHILPANCINGO DE LOS BRAVO.	0.00		233,817.22		0.00	233,817.22
56114022001026002078	REHABILITACION DE CAMINO RURAL TRAMO: SAN VICENTE-EL AHUJITO, MUNICIPIO DE CHILPANCINGO DE LOS BRAVO.	0.00		155,082.85		0.00	155,082.85
56114022001026002079	REHABILITACION DE CAMINO RURAL TRAMO: CRUCERO LA CUMBRE-RINCON DE ALCAPARROSA-AGUA HERNADEZ, MUNICIPIO DE CHILPANCINGO DE LOS BRAVO.	0.00		210,435.50		0.00	210,435.50
56114022001026002080	REHABILITACION DE ALUMBRADO PUBLICO EN LA ZONA PONIENTE DE LA LOC. DE CHILPANCINGO, MUNICIPIO DE CHILPANCINGO DE LOS BRAVO.	0.00		820,092.16		0.00	820,092.16
56114022001026002081	REHABILITACION DE ALUMBRADO PUBLICO EN LA ZONA ORIENTE DE LA LOC. DE CHILPANCINGO, MUNICIPIO DE CHILPANCINGO DE LOS BRAVO.	0.00		1,176,832.25		0.00	1,176,832.25
56114022001026002082	REHABILITACION DE ANDADORES Y PLAZOLETA EN LOS ESPACIOS PUBLICOS DE LAS INSTALACIONES DE LA FERIA DE NAVIDAD Y AÑO NUEVO DE LA LOC. DE CHILPANCINGO, MUNICIPIO	0.00		1,162,282.02		0.00	1,162,282.02

Handwritten signature and stamp of the Municipal Administrative and Financial Secretary.



H. Ayuntamiento Municipal Constitucional de Chilpancingo, Gro. SECRETARIA DE FINANZAS Y ADMINISTRACION



H. AYUNTAMIENTO MUNICIPAL DE CHILPANCINGO, GRO.  
SECRETARIA DE FINANZAS Y ADMINISTRACION

CONSOLIDADO



BALANZA DE COMPROBACIÓN DEL 1 DE ENERO AL 31 DE DICIEMBRE DEL 2019

C U E N T A	C O N C E P T O	SALDOS INICIALES		MOVIMIENTOS		SALDOS ACUMULADOS	
		AL 1 DE ENERO DE 2019		ENERO - DICIEMBRE 2019		AL 31 DE DICIEMBRE DE 2019	
		DEBE	HABER	DEBE	HABER	DEBE	HABER
56114022001026002083	DE CHILPANCINGO DE LOS BRAVO. REHABILITACION DE JARDINERAS EN LA ALAMEDA GRANADOS MALDONADO DE LA COLONIA CENTRO DE LA LOC DE CHILPANCINGO, MUNICIPIO DE CHILPANCINGO DE LOS BRAVO.	0.00		904,447.05	0.00	904,447.05	
56114022001026002084	PAVIMENTACION DE CAMINO RURAL A SAN VICENTE. TRAMO: DEL KM 0+000 AL KM 20+000, SUBTRAMO: DEL KM 8+000 AL KM 8+000. MUNICIPIO DE CHILPANCINGO DE LOS BRAVO.	0.00		15,000,000.00	90,638.51	14,909,361.49	
56114022001026002085	(CONVENIO DE COORDINACION CON CICAEG) REHABILITACION DE CAMINO RURAL EN LA LOC. DE EL CIRUELAR, MUNICIPIO DE CHILPANCINGO DE LOS BRAVO.	0.00		491,410.82	0.00	491,410.82	
56114022001026002086	REHABILITACION DE PAVIMENTO CON MEZCLA ASFALTICA EN CALIENTE EN LA CALLE VELAZQUEZ DE LEON TRAMO: CALLE HEROINAS DEL SUR-CALLE ACAPULCO, DE LA COLONIA LOS ANGELES, LOC DE CHILPANCINGO, MUNICIPIO DE CHILPANCINGO DE LOS BRAVO.	0.00		662,728.52	0.00	662,728.52	
56114022001026002087	REHABILITACION DE LA PLAZOLETA EN EL BARRIO DE SAN ANTONIO, EN LA LOC. DE CHILPANCINGO, MUNICIPIO DE CHILPANCINGO DE LOS BRAVO.	0.00		109,895.22	0.00	109,895.22	
56114022001026002088	REHABILITACION DE ACCESO A LA OBRA DE TOMA EN LA LOC. DE EL CALVARIO, MUNICIPIO DE CHILPANCINGO DE LOS BRAVO.	0.00		721,476.73	0.00	721,476.73	
56114022002	URBANIZACION (RENDIMIENTOS FINANCIEROS) EJERCICIO 2019	0.00		405,674.76	0.00	405,674.76	
56114022002026	CONTRATO	0.00		405,674.76	0.00	405,674.76	
56114022002026001	REHABILITACION DE PUENTE PEATONAL EN LA LOCALIDAD DE EL CIRUELAR, MUNICIPIO DE CHILPANCINGO DE LOS BRAVO.	0.00		405,674.76	0.00	405,674.76	
56114023	FONDO DE APORT PIFORT DE LOS MPIOS EJERCICIO 2019	0.00		405,674.76	0.00	405,674.76	
56114023026	URBANIZACION	0.00		16,108,501.49	7,404,307.00	8,704,194.49	
56114023026001	PROYECTO INTEGRAL DE LA CONSTRUCCION DE LA OBRA DE INFRAESTRUCTURA PARA EL RELLENO SANITARIO CELDA 01, CONSISTENTE EN LA DISPOSICION FINAL DE LOS RESIDUOS SOLIDOS NO PELIGROSOS, UBICADO EN LA CARRETERA CHILPANCINGO-TIXTLA KM 4.6 DENOMINADO CERRO DEL HUITECO, EN EL MUNICIPIO DE CHILPANCINGO, GRO	0.00		16,108,501.49	7,404,307.00	8,704,194.49	
56114023026001001	CONSTRUCCION DE RELLENO SANITARIO EL HUITECO, SEGUNDA ETAPA, EN EL MUNICIPIO DE CHILPANCINGO, GRO	0.00		7,812,654.50	423,000.00	7,389,654.50	
56114023026001002	ADQUISICION DE LUMINARIA TIPO URBANA CON LAMPARA DE ALTA POTENCIA Y TABLETA TITAN LED DE CARGAZA DE ALUMINIO INYECTADO DE	0.00		1,592,456.25	1,592,456.25	0.00	
56114023026001003		0.00		2,463,701.36	2,463,701.36	0.00	

*[Handwritten signature and stamp]*



H. Ayuntamiento Municipal, Constitución de Chilpancingo, Gro. Contraloría Interna Municipal





H. AYUNTAMIENTO MUNICIPAL DE CHILPANCINGO, GRO.  
SECRETARIA DE FINANZAS Y ADMINISTRACION

CONSOLIDADO



BALANZA DE COMPROBACIÓN DEL 1 DE ENERO AL 31 DE DICIEMBRE DEL 2019

C U E N T A	C O N C E P T O	SALDOS INICIALES		M O V I M I E N T O S		SALDOS ACUMULADOS	
		AL 1 DE ENERO DE 2019		ENERO - DICIEMBRE 2019		AL 31 DE DICIEMBRE DE 2019	
		DEBE	HABER	DEBE	HABER	DEBE	HABER
56114023026001004	100W. (SIN SPORTE) REHABILITACION DE ACCESOS Y REORDENAMIENTO EN EL RELLENO SANITARIO LIMPIEZA DE BARRANCAS EN EL MUNICIPIO DE CHILPANCINGO	0.00	0.00	1,278,400.01	814,400.01	464,000.00	
56114023026001005	CONSTRUCCION PRIORITARIOS PARA LA PREVENCIÓN DEL RELLENO SANITARIO DENOMINADO "EL HUITECO" UBICADO EN EL KM 4.5 DE LA CARRETERA LIBRAMIENTO CHILPANCINGO-TIXTLA	0.00	0.00	1,372,062.15	1,372,062.15	0.00	
56114023026001006	PROYECTO EJECUTIVO PARA RELLENO A CIELO ABIERTO PRIMERA ETAPA, EN EL MUNICIPIO DE CHILPANCINGO DE LOS BRAVO.	0.00	0.00	1,166,227.22	738,687.23	427,539.99	
56114023026001007	EDIFICACIONES NO HABITACIONALES FONDO PARA LA INFRAESTRUCTURA SOCIAL DE LOS MUNICIPIOS	0.00	0.00	423,000.00	0.00	423,000.00	
561160220060260026	CONDICIONAMIENTO DE ESPACIOS FISICOS EJERCICIO 2019	0.00	0.00	1,034,321.90	0.00	1,034,321.90	
561160220060260027	CONTRATO	0.00	0.00	1,034,321.90	0.00	1,034,321.90	
561160220060260028	REHABILITACION DE MODULOS SANITARIOS DEL H. AYUNTAMIENTO MUNICIPAL (PRODIM)	0.00	0.00	1,034,321.90	0.00	1,034,321.90	
561160220060260029	REHABILITACION DEL EDIFICIO DEL H. AYUNTAMIENTO MUNICIPAL (PRODIM)	0.00	0.00	203,208.78	0.00	203,208.78	
561160220060260030	REMODELACION DE LAS OFICINAS DE LA SECRETARIA DE OBRAS PUBLICAS DEL H. AYUNTAMIENTO MUNICIPAL DE CHILPANCINGO DE LOS BRAVO (PRODIM)	0.00	0.00	448,674.70	0.00	448,674.70	
561160220060260031	ADQUISICION DE MOBILIARIO PARA LA REMODELACION DE LAS OFICINAS DEL H. AYUNTAMIENTO MUNICIPAL DE CHILPANCINGO DE LOS BRAVO (PRODIM)	0.00	0.00	199,978.77	0.00	199,978.77	
56131022002	PROYECTOS PRODUCTIVOS Y ACCIONES DE FOMENTO	0.00	0.00	182,459.65	0.00	182,459.65	
56131022002026	PROYECTOS PRODUCTIVOS Y ACCIONES DE FOMENTO	0.00	0.00	2,192,056.55	0.00	2,192,056.55	
56131022002026001	FONDO DE APORTACION PARA LA INFRAESTRUCTURA SOCIAL MUNICIPAL OTROS PROYECTOS	0.00	0.00	2,192,056.55	0.00	2,192,056.55	
56131022002026002	EJERCICIO 2019	0.00	0.00	2,192,056.55	0.00	2,192,056.55	
56131022002026003	CONTRATO	0.00	0.00	2,192,056.55	0.00	2,192,056.55	
56131022002026004	APERTURA DE BRECHA SACA COCECHAS, EN LA LOCALIDAD DE COCACUYILLO EN EL MUNICIPIO DE CHILPANCINGO DE LOS BRAVO, ESTADO DE GUERRERO.	0.00	0.00	2,192,056.55	0.00	2,192,056.55	
56131022002026005		0.00	0.00	1,108,535.61	0.00	1,108,535.61	







H. AYUNTAMIENTO MUNICIPAL DE CHILPANCINGO, GRO.  
SECRETARÍA DE FINANZAS Y ADMINISTRACIÓN  
CONSOLIDADO



BALANZA DE COMPROBACIÓN DEL 1 DE ENERO AL 31 DE DICIEMBRE DEL 2019

C U E N T A	C O N C E P T O	SALDOS INICIALES		MOVIMIENTOS		SALDOS ACUMULADOS	
		AL 1 DE ENERO DE 2019		ENERO - DICIEMBRE 2019		AL 31 DE DICIEMBRE DE 2019	
		DEBE	HABER	DEBE	HABER	DEBE	HABER
56131022002026002002	APERTURA DE BRECHA SACA COCECHAS EN LA LOCALIDAD DE CARRIZAL EN EL MUNICIPIO DE CHILPANCINGO DE LOS BRAVO, GUERRERO. CUENTAS DE ORDEN PRESUPUESTARIAS	0.00		1,083,520.94		0.00	1,083,520.94
8	LEY DE INGRESOS	0.00		7,408,793,694.46		0.00	0.00
81	LEY DE INGRESOS ESTIMADA	0.00		2,644,986,747.72		0.00	0.00
811	LEY DE INGRESOS POR EJECUTAR MODIFICACIONES A LA LEY DE INGRESOS ESTIMADA	0.00	0.00	734,311,516.43		0.00	734,311,516.43
812	LEY DE INGRESOS RECAUDADA	0.00	0.00	881,662,249.24		0.00	881,662,249.24
813	LEY DE INGRESOS DEVENGADA	0.00	0.00	147,350,732.81		0.00	147,350,732.81
814	PRESUPUESTO DE EGRESOS APROBADO	0.00	0.00	881,662,249.24		0.00	881,662,249.24
815	MODIFICACIONES AL PRESUPUESTO DE EGRESOS APROBADO	0.00	0.00	0.00		0.00	0.00
82	PRESUPUESTO DE EGRESOS DEVENGADO	0.00	0.00	4,763,806,946.74		0.00	4,763,806,946.74
821	MODIFICACIONES AL PRESUPUESTO DE EGRESOS DEVENGADO	0.00	0.00	0.00		0.00	0.00
822	EGRESOS APROBADO	0.00	0.00	881,662,249.24		0.00	881,662,249.24
823	EGRESOS DEVENGADO	0.00	0.00	87,809,397.34		-88,933,509.28	793,852,851.90
824	EGRESOS EJERCIDO	0.00	0.00	970,595,758.52		0.00	970,595,758.52
825	EGRESOS PAGADO	0.00	0.00	970,476,590.23		0.00	970,476,590.23
826		0.00	0.00	970,476,590.23		0.00	970,476,590.23
827		0.00	0.00	970,476,590.23		0.00	970,476,590.23
		386,956,001.81	386,956,001.81	12,568,240,237.73	12,568,240,237.73	3,198,182,704.53	3,198,182,704.53

Bajo protesta de decir verdad declaramos que los estados financieros y sus notas son correctas, verídicas y responsabilidad del emisor



2018  
2019  
2020  
2021  
Elaboró:  
SECRETARÍA DE FINANZAS Y ADMINISTRACIÓN  
Y SERVICIO DE FINANZAS Y ADMINISTRACIÓN

2018  
2019  
2020  
2021  
Autorizó:  
LIC. ANTONIO GASPÁR BELTRÁN  
PRESIDENTE MUNICIPAL

2018  
2019  
2020  
2021  
LIC. VANÉY CASTORENA TENORIO  
PRIMER SINDICADO PROCURADOR

2018  
2019  
2020  
2021  
Revisó:  
LIC. FRANCISCO JAVIER RÍOS MARTÍNEZ  
CONTADOR INTERNO MUNICIPAL  
CONTRALORIA INTERNA MUNICIPAL